

A modern kitchen featuring a large island with a marble countertop and dark blue cabinetry. The island is surrounded by light-colored wooden bar stools. The background shows a stainless steel range hood, a gas cooktop, and a sink with a gold faucet. The kitchen is well-lit with pendant lights and recessed lighting.

Century Cabinetry
Quality · Style · Value

Specifications Manual | 2023/2024

Table of Contents

Item Directory	1 - 3
Specifications	4 - 18
Nomenclature	5
Dimensional Specifications	6 - 7
Cabinet Construction.....	8 - 13
Terms & Policies.....	14
Warranty Information.....	15
Product Care & Cleaning.....	16
Industry Qualifications.....	17
Custom Item Form.....	18
Doors & Finishes	19 - 41
Wood Species Information.....	20
Finish Information.....	21
Gatehouse Finish Availability Chart.....	22
Carriage House Finish Availability Chart.....	23
Gatehouse Quick Reference.....	24
Carriage House Quick Reference.....	25 - 31
Gatehouse Door Styles (Including Glass/Mullion).....	32 - 33
Carriage House Door Styles (Including Glass/Mullion).....	34 - 41
Wall Cabinetry	42 - 56
Index.....	43
Construction Options & Modifications Key	44
Cabinet Selection.....	45 - 55
Frame With Doors (DRFF).....	55 - 56
Specialty Wall Cabinetry	57 - 68
Index.....	58
Construction Options & Modifications Key	59
Cabinet Selection.....	60 - 68
Lite Specifications	69
Base Cabinetry	70 - 84
Index.....	71
Construction Options & Modifications Key	72
Cabinet Selection.....	73 - 83
Frame With Doors (DRFF).....	84
Tall Cabinetry	85 - 91
Index.....	86
Construction Options & Modifications Key	87
Cabinet Selection.....	88 - 91
Vanity & Office Cabinetry	92 - 98
Index.....	93
Construction Options & Modifications Key	94
Cabinet Selection.....	95 - 98

Table of Contents

Fillers & Panels	99 - 109
Index.....	100
Fillers.....	101 - 104
End Panels.....	105
End Fillers.....	106 - 107
Decorative End Panels.....	108 - 109
Accessories	110 - 114
Index.....	111
Standard and Upgraded Hardware.....	112
Upgraded 2 Hardware.....	113
Cutlery Tray Inserts, Peg Board Drawer Inserts.....	114
Moldings & Decorative Accessories	115 - 122
Index.....	116
Moldings.....	117 - 118
Legs, & Posts.....	119
Plate Covers, Corbels, & Brackets.....	120
Arched Valances	121
Mantels	122
Modular Decorative Items	123 - 127
Index.....	124
Column Corbel Shakers.....	125 - 126
Pilasters.....	127
Replacement Items	128 - 143
Index.....	129
Miscellaneous Items.....	130
Sample Doors & Color Blocks	131
Door Drilling Information.....	132
Gatehouse Doors & Drawer Heads.....	133
Gatehouse Glass & Mullion Doors.....	134
Gatehouse Drawers & Pullouts.....	135
Gatehouse Shelving.....	136
Gatehouse Veneer Shelving.....	137
Carriage House Doors & Drawer Heads.....	138
Carriage House Glass & Mullion Doors.....	139
Carriage House Drawers & Pullouts.....	140 - 141
Carriage House Shelving.....	141
Carriage House Veneer Shelving.....	142
Plywood.....	143

Table of Contents

EURO Specifications	144 - 150
Construction Features, Upgrade Options & Modifications.....	145
Terms & Policies.....	146
Warranty Information.....	147
Product Care & Cleaning.....	148
Industry Qualifications.....	149
Custom Item Form.....	150
EURO Doors & Finishes	151 - 154
EURO Door Style Quick Reference.....	152
EURO Door Styles & Finish Information (Including Glass).....	153 - 154
EURO Wall Cabinetry	155 - 161
Index.....	156
Construction Options & Modifications Key	157
Cabinet Selection.....	158 - 161
EURO Specialty Wall Cabinetry	162 - 166
Index.....	163
Construction Options & Modifications Key	164
Cabinet Selection.....	165 - 166
EURO Base Cabinetry	167 - 173
Index.....	168
Construction Options & Modifications Key	169
Cabinet Selection.....	170 - 173
EURO Tall Cabinetry	174 - 178
Index.....	175
Construction Options & Modifications Key	176
Cabinet Selection.....	177 - 178
EURO Vanity & Office Cabinetry	179 - 184
Index.....	180
Construction Options & Modifications Key	181
Cabinet Selection.....	182 - 184
EURO Fillers, Panels & Moldings	185 - 189
Index.....	186
Fillers.....	187 - 188
End Panels.....	188
Moldings.....	189
EURO Accessories	190 - 194
Index.....	191
Standard and Upgraded Hardware.....	192
Upgraded 2 Hardware.....	193
Cutlery Tray Inserts.....	194

Table of Contents

EURO Replacement Items	195 - 204
Index.....	196
Miscellaneous Items	197
Door Drilling Information.....	198
Doors & Drawer Heads.....	199
Glass Doors.....	200
Drawers & Pullouts.....	201 - 202
EUROTECH Drawers	202 - 203
EUROTECH Pullouts & Shelving.....	204
Trim Kits	205
Appliance Panels	206 - 233
Panel Specifications.....	207 - 233

TAB: Item Directory

Item Directory

Code	Description	Page	Code	Description	Page
AD	Apron Drawer	98	CMT	Crown Molding-Large	117
ADK	Apron Drawer Keyboard	98	COFC	Counter Depth Coffee Maker Cabinet	49
ALMSTL	Alumasteel Liner	55, 105	COLOR BLOCK	1 Color Block Sample	131
ARDV	Arch Radius Decorative Valance	121	COLORS ALL (CHS)	Full Lines Color Block Samples	131
AV	Arch Valance	121	COLOR SET (GHS)	All Gatehouse Color Block Samples	131
AVS	Arch Valance "Shaker"	121	CS	Corbel - Shaker	120
B	Base	73	CSK	Custom Shelf Kit	118, 142
B-21	Base - 21" Depth	83	CT	Cutlery Tray Drawer Insert	114
B-21-2T	Base - 21" Depth - 2 Pullouts	83	CTB	Cook Top Base	75
B-2T	Base - 2 Pullouts	81	CTB-2T	Cook Top Base - 2 Pullouts	82
B4D	Base 4 Drawer	75	CUB	Cubbies	53
BBAS	Base Basket	76	DDF	Desk Deep File	98
BBC	Base Blind Corner	79	DF	Desk File	98
BBCFH	Base Blind Corner Full Height	79	DFICS	Diagonal Filler Inside Corner "Shaker"	103
BBCFH-2T	Base Blind Corner Full Height - 2 Pullouts	83	DH	Gatehouse Drawer Heads	133
BBCSO	Base Blind Corner Swing Out	79	DH / DHBP	Carriage House Drawer Heads	130
BBCFHSO	Base Blind Corner Full Height Swing Out	79	DISPLAY RACK	Door Display Rack	130
BC	Base Chrysler (45° Cabinet)	80	DL	Desk Leg	98
BC	Base Corner	80	DR	Carriage House Doors	138
BCT	Base Cooktop	75	DR	Gatehouse Doors	133
BCM	Bottom Casement Molding	117	DRFF	Door Face Frame	55, 56
BCS	Base Corner Shelf "Similar to BLS"	79	DRFFB	Door Face Frame Base	84
BD	Base Drawer	75-76	DRFIC	Diagonal Reeded Filler Inside Corner	103
BD-ADA	Base Drawer - ADA	77	DRG / DRM	Carriage House Glass / Mullion Doors	139
BD-2T	Base Drawer - 2 Pullouts	82	DRG / DRM	Gatehouse Glass / Mullion Doors	134
BDCT	Base Drawer Cooktop	76	DRWR HD SCREW	Drawer Head Screws	130
BDD	Base Deep Drawer	75	ECF	End Corner Filler	101
BDRT	Base Double Range Top	76	EFF	End Filler Flat	106
BEC	Base End Corner	81	EFFN	End Filler Flat Narrow	106
BEU	Base End Unit	81	EFO	End Filler Overlay	106
BEUOS	Base End Unit Open Shelf	81	EFF-R	End Filler Flat with Return	107
BEUWR	Base End Unit Wine Rack	81	EFFN-R	End Filler Flat Narrow with Return	107
BFH	Base Full Height	73-74	EFO-R	End Filler Overlay with Return	107
BFH-21	Base Full Height - 21" Depth	83	EP	End Panel	105
BFH-21-2T	Base Full Height - 21" Depth - 2 Pullouts	83	EPB	End Panel -Base - "Skin"	105
BFH-2T	Base Full Height - 2 Pullouts	82	EPDR	End Panel Door	108 - 109
BLOCK BOX	1 Color Block Sample Box	131	EPW	End Panel - Wall - "Skin"	105
BLS	Base Lazy Susan	69	F	Filler	101
BLSU	Base Lazy Susan with Upgraded Tray	80	F-ALMSTL	Alumasteel Filler	101
BMW	Base Microwave Cabinet	75	F-OL	Filler with Overlay	101
BMX	Base Mixer Cabinet	76	F45	Angle Filler	103
BOARD	Hardware Board	130	F58	Starter Filler	102
BPO	Base Pullout	74	FDSK	Carriage House Full Depth Shelves	141
BPOC	Base Pullout with Canisters	74	FDSK	Gatehouse Full Depth Shelves	136
BT	Base Tray	73	FLSH	Floating Shelf	118
BTBM	Beaded Top / Bottom Molding	117	FS	Filler "Shaker"	104
BTC	Base Trash Cabinet	74	FSF	Farm Sink Front	78
BTCFH	Base Trash Cabinet Full Height	75	FTK	Furniture Toe Kick	118
BTF	Shaker Bunn Foot	121	GSK	Carriage House Glass Shelves	142
BUMPER PAD	Bumper Pads	130	HAVF	Hanging Arrow Vanity Front	98
CARE-KIT	Complete Touch Up Kit (ALL COLORS)	130	HINGE	Hinges	130
CBPL	Counterbalance Bracket	120	HWD	Standard/Upgraded/Upgraded 2 Hardware	112 - 113
CF	Corner Filler (Flat)	102	ICM	Inside Corner Molding	118
CF-OL	Corner Filler (Overlay)	102	KNF	Knife Block Drawer Insert	114
CM	Crown Molding	117	LAMINATE	Laminate Sheet	105
CMA	Crown Molding-Angled	117	LBS	L-Bracket Shaker	120
CMC	Crown Molding-Coved	117	LONG SCREW	Installation Screw - Long 3"	130
CMS	Crown Molding-Small	117	LVM	Light Valance Molding	118

Item Directory

Code	Description	Page	Code	Description	Page
LVSH	Light Valance Shaker Molding	118	SPICE RACK	Carriage House Spice Pullouts	140
MANTEL	Mantel	122	SPICE RACK	Gatehouse Spice Pullouts	135
MS	Mantel "Shaker"	122	SS	Scribe Molding	117
MS1	Machine Screw 1"	130	STRIKE CATCH	Strike Catch	130
MT	Mirror Trim	118	SV	Straight Valance	121
MW	Wall Microwave Cabinet	49	TCM	Top Casement Molding	117
OC	Oven Cabinet	89	TKC	Toe Kick Cover	118
OC-TKF	Oven Cabinet - Trim Kit Full	90	TKCA	Toe Kick Cover Arched	122
OC-WDR	Oven Cabinet - Warming Drawer	90	TKE	Toe Kick End	118
OCM	Outside Corner Molding	118	TOT	Turn Out Trays	130
OTK	Oven Trim Kit	91	TU	Touch Up	130
OTKF	Oven Trim Kit Full	91	TRASH CAN	Carriage House Trash Can	140
P	Legs	119	TRASH CAN	Gatehouse Trash Can	135
PANEL-APPL	Appliance Panel	207	TT	Tank Topper	97
PB	Panel Backer	105	UC	Utility Cabinet	88
PBB	Panel Backer Beaded	105	UC-4T	Utility Cabinet - 4 Pullouts	88-89
PBDI	Peg Board Drawer Insert	114	UEC	Utility End Cabinet	89
PCCS	Pilaster Column Corbel Shaker	125-126	UMG	Undermount Glides	132
PLATE	Plate	120	UT	Utility Tray Drawer Insert	114
PLASTIC CAP	Plastic Caps	130	V1D	Vanity 1 Drawer	97
PLS	Pilaster Leg Shaker	119	V4D	Vanity 4 Drawer	97
PIL	Pilaster	119	V4M	Valance	118
PO-CANS	Pullouts with Canisters	140	VB	Vanity Base	95
POT / POTC / POKT	Gatehouse Pullout Tray Kits	135	VBD	Vanity Base Drawer	96
POT / POTC / POKT	Carriage House Pullout Tray Kits	140-141	VBDB	Vanity Base Drawer Base	96
PS	Pilaster "Shaker"	127	VBDD	Vanity Base Double Drawer	96
PSK	Carriage House Pantry Shelf Kits	141	VBDFH	Vanity Base Drawer Full Height	97
PSK	Gatehouse Pantry Shelf Kits	136	VBRF-ADA	Vanity Base Removable Front	97
RDK	Carriage House Drawer Kits	140-141	VBS	Vanity Base Space Saver	95
RDK	Gatehouse Drawer Kits	135	VD	Vanity Drawer	97
RH	Range Hood	55	VD-ADA	Vanity Drawer - ADA	98
RHT	Range Hood Tapered	54	VEP	Veneer End Panel	105
RPK	Carriage House Pullouts	140	VL	Vanity Linen	97
RPK	Gatehouse Pullouts	135	VSB	Vanity Sink Base	96
S	3" Spacer Drawer Insert	114	VSB-HV-ADA	Vanity Sink Base Removable Front	98
SAMPLE DOOR	Sample Door 15" x 18" No Drilling	130		Hanging Vanity - ADA	
SDW	Sample Door	131	VSBS	Vanity Sink Base Space Saver	95
SB	Sink Base	76-77	VSH	Gatehouse Veneer Shelves	137
SBB	Sink Base "Base" Combo	78	VSH	Carriage House Veneer Shelves	142-143
SBD	Sink Base Drawer	78	VSHWC	Gatehouse Veneer Wall Corner Shelves	137
SBDFH	Sink Base Drawer Full Height	78	VSHWC	Carriage House Veneer Wall Corner Shelves	142-143
SBFH	Sink Base Full Height	77	W	Wall	45-48
SBFS	Sink Base Farm Sink	78	WBC	Wall Blind Corner	50
SBFHRF-ADA	Sink Base Full Ht Removable Front-ADA	77	WBS	Wall Book Shelf	60-61
SBTC	Sink Base Trash Cabinet	78	WC	Wall Corner	49
SBTCFH	Sink Base Trash Cabinet Full Height	78	WCLS	Wall Corner Lazy Susan	49-50
SFD	Sink Front Diagonal	80	WCSH	Carriage House Wall Corner Shelves	141
SFD FLOOR	Sink Floor	80	WCSH	Gatehouse Wall Corner Shelves	136
SFDFH	Sink Front Diagonal Full Height	80	WD	Wall Drawer	51-53
SH	Carriage House 12" / 15" / 24" Shelves	141	WEC	Wall End Corner	51
SH	Gatehouse 12" / 15" / 24" Shelves	136	WG	Wall Glass	62-66
SHELF PINS	Carriage House Shelf Hardware	141-142	WGC	Wall Glass Corner	66
SHELF PINS	Gatehouse Shelf Hardware	136-137	WGD	Wall Glass Drawer	67-68
SHOE	Shoe Molding	118	WGEC	Wall Glass End Corner	66
SHORT SCREW	Installation Screw - Short 1 5/8"	130	WGPC	Wall Glass Pie Cut Corner	61
SMG	Sidemount Glides	130	WLIFT	Wall Lift-Up	53
SPC	Spice Tray Drawer Insert	114	WM	Wall Mullion	62-66

Item Directory

Code	Description	Page	Code	Description	Page
WMC	Wall Mullion Corner	66	WPCSH	Gatehouse Wall Pie Cut Corner Shelf	136
WMD	Wall Mullion Drawer	67-68	WPCSH	Carriage House Wall Pie Cut Corner Shelf	141
WMEC	Wall Mullion End Corner	66	WRD	Wine Rack Diagonal	48
WNS	What Not Shelf	61	WRH	Wall Range Hood Kit	54
WOS	Wall Open Shelf	60	WRL	Wine Rack Lattice	48
WPC	Wall Pie Cut Corner	51	WSR	Wine Stem Rack	48

EURO

Code	Description	Page	Code	Description	Page
AD	Apron Drawer	184	POTC / POKT	Euro Pullout Tray Kits	204
ALMSTL	Alumasteel Liner	188	PSK	Pantry Shelf Kits	204
B	Base	170	RDK	Drawer Kits	202
B4D	Base 4 Drawer	170	RDKM	Euro Tech Drawer Kits	203
BBC	Base Blind Corner	171	RPK	Euro Pull Outs	204
BBCFHSO	Base Blind Corner for Height Swing Out	172	SAMPLE DOOR	Sample Door 15" x 18" No Drilling	197
BBCSO	Base Blind Corner Swing Out	172	SB	Sink Base	172
BCS	Base Corner Shelf "Similar to BLS"	172	SBFH	Sink Base Full Height	173
BCT	Base Cooktop	173	SBFS	Sink Base Farm Sink	173
BDCT	Base Drawer Cooktop	173	SBRF-ADA	Sink Base Full Height Removable Front-ADA	173
BD	Base Drawer	170	SH	Euro Shelves	204
BD-ADA	Base Drawer-ADA	173	SHOE	Shoe Housing	189
BDD	Base Deep Drawer	170	SMG21-BTC	21D Base Trash Can Glides	196
BDRT	Base Drawer Range Top	170	SPICE RACK	Euro Spice Pullouts	204
BFH	Base Full Height	171	SS	Scribe	189
BLS	Base Lazy Susan	172	TKC	Toe Kick Cover	188
BMW	Base Microwave Cabinet	170	TRASH CAN	Euro Trash Can	204
BPO	Base Pullout	171	UC	Utility Cabinet	177
BT	Base Tray	171	V1D	Vanity 1 Drawer	182
BTC	Base Trash Cabinet	171	V4D	Vanity 4 Drawer	182
BTCFH	Base Trash Cabinet Full Height	171	VB	Vanity Base	182
CF	Corner Filler (Flat or Overlay)	187	VBD	Vanity Base Drawer	182
COLOR BLOCK	1 Color Block Sample	197	VBRF-ADA	Vanity Base Removable Front - ADA	183
CT	Cutlery Tray Drawer Insert	194	VBS	Vanity Base Space Saver	182
DDF	Desk Deep File	184	VD	Vanity Drawer	182
DF	Desk File	184	VD-ADA	Vanity Drawer - ADA	183
DH	Euro Drawer Heads	199	VL	Vanity Linen	183
DR	Euro Doors	199	VSB	Vanity Sink Base	183
DRG	Euro Glass Doors	200	VSB-HV-ADA	Vanity Sink Base - Hanging Vanity - ADA	183
EFF	End Filler Flat	187	W	Wall	158-159
EFF-R	End Filler Flat with Return	187	WBC	Wall Blind Corner	160
EP	End Panel	188	WC	Wall Corner	160
F	Filler	187	WCSH/WPCSH	Euro Wall Corner Shelves	204
F-ALMSTL	Alumasteel Filler	188	WD	Wall Drawer	160
F-OL	Filler with Overlay	187	WFLIP	Wall Flip Up	159
FDSK	Euro Full Depth Shelf Kits	204	WG	Wall Glass	165-166
FLSH	Floating Shelf	189	WGC	Wall Glass Corner	166
FTK	Furniture Toe Kick	189	WGD	Wall Glass Drawer	166
FSF	Farm Sink Front	173	WGFLIP	Wall Glass Flip	166
HAVF	Hanging Apron Vanity Front	183	WGLIFT	Wall Glass Lift-Up	166
HINGE	Hinges	197	WGPC	Wall Glass Pie Cut Corner	166
HWD	Standard/Upgraded/Upgraded 2 Hardware	192-193	WLIFT	Wall Lift-Up	160
LAMINATE	Laminate Sheet	183	WPC	Wall Pie Cut	160
OC	Oven Cabinet	178	WRH	Wall Range Hood	161
OTK	Oven Trim Kit	205			
PB	Panel Backer	188			

TAB: Specifications

Specifications

- ***Nomenclature***
- ***Dimensional Specifications***
- ***Cabinet Construction***
 - *Full Access (Frameless)*
 - *Framed*
 - *Framed (All Wood Construction)*
 - *Drawers and Pullouts*
 - *End Panel Options*
 - *Cabinet Modifications*
- ***Terms & Policies***
- ***Warranty Information***
- ***Product Care & Cleaning***
- ***Industry Qualifications***
- ***Custom Item Form***

Specifications: Nomenclature

Century's Full Item Code

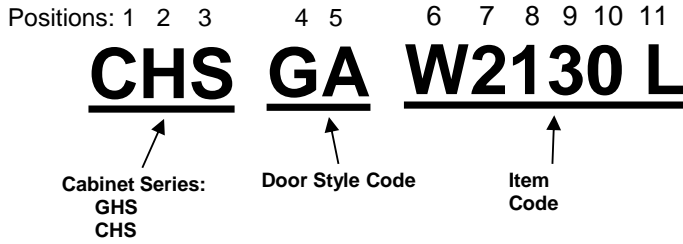

Century Full item code is 17 positions long

- Positions 1 to 3 = Cabinet Series
Ex : GHS / CHS
- Positions 4 to 5 = Door Style Code
Ex : GA = Georgetown Auburn
- Positions 6 to 17 = 12 Position Item Code
Ex : W2130L or B15L

Wall Cabinets - Dimension and Handing Nomenclature

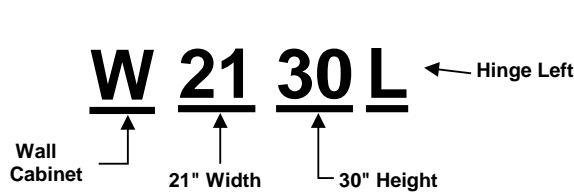

For Walls - Standard depth = 12". You only note depth when it is not the standard for that type of cabinet

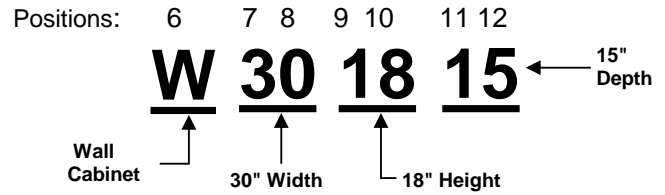

- Width - Positions 7 - 8
- Height - Positions 9 - 10
- Depth - Positions 11 - 12

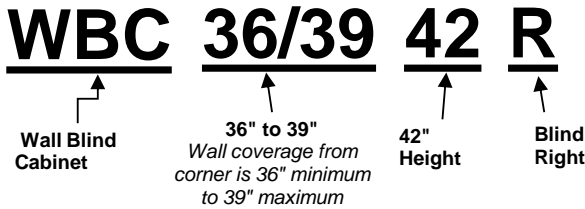

If item does not have numbers in position 11 and 12 the depth is 12"

Base Cabinets - Dimension and Handing Nomenclature

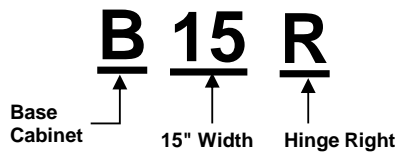

Utility Cabinets - Dimension and Handing Nomenclature

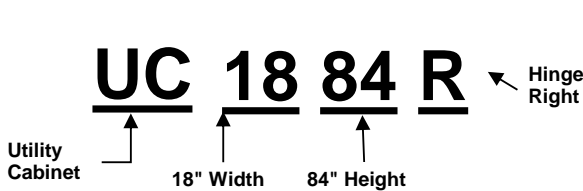

For UC - Standard depth = 12"

You only note depth when it is not the standard for that type of cabinet

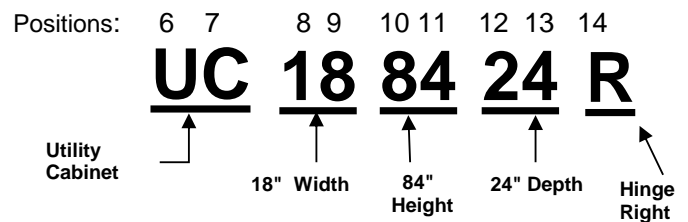

- Width - Positions 8 - 9
- Height - Positions 10 - 11
- Depth - Positions 12 - 13
- Handing - Position 14

*If item does not have numbers in position 12 & 13 the depth is 12"

Specifications: Dimensional Specifications

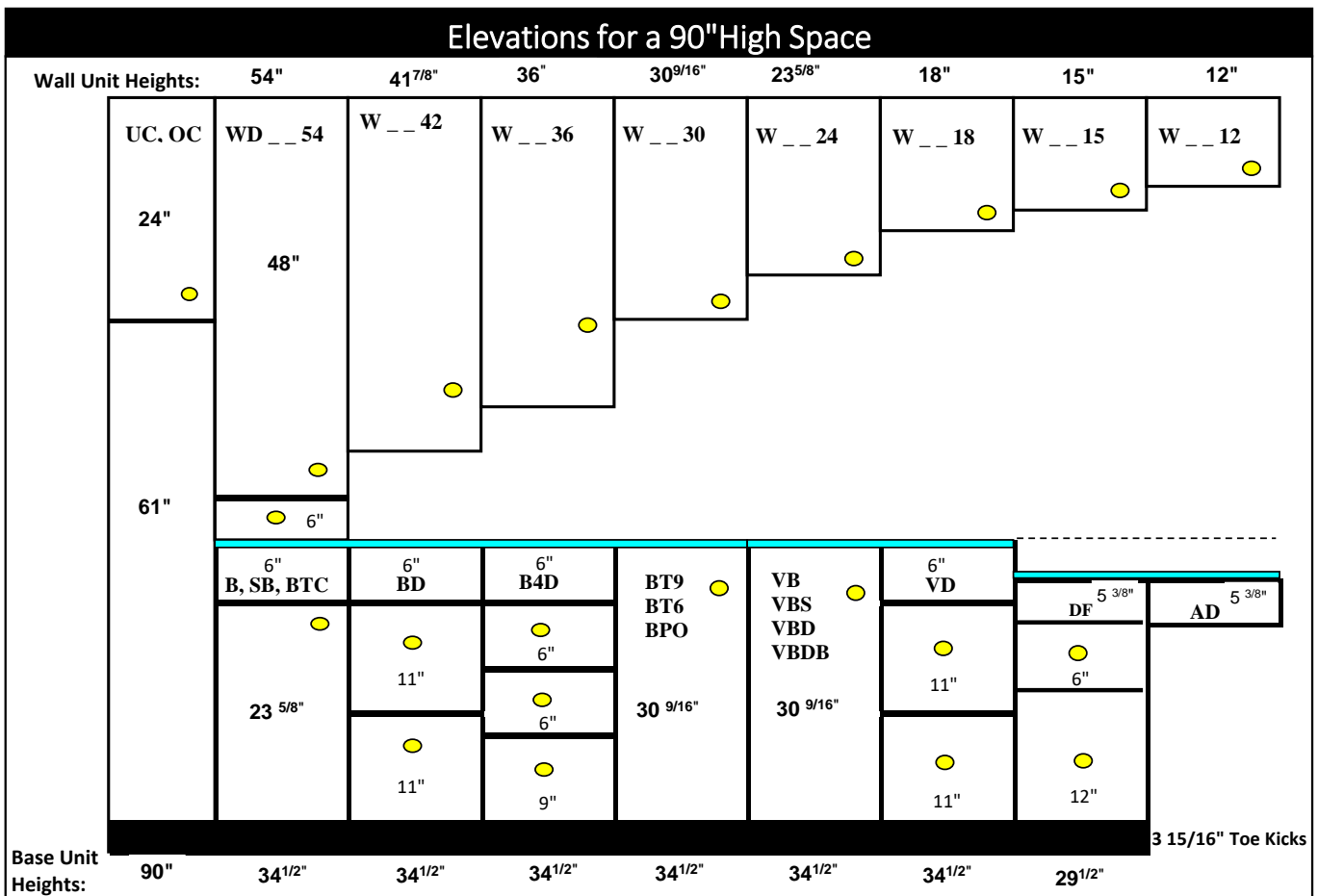
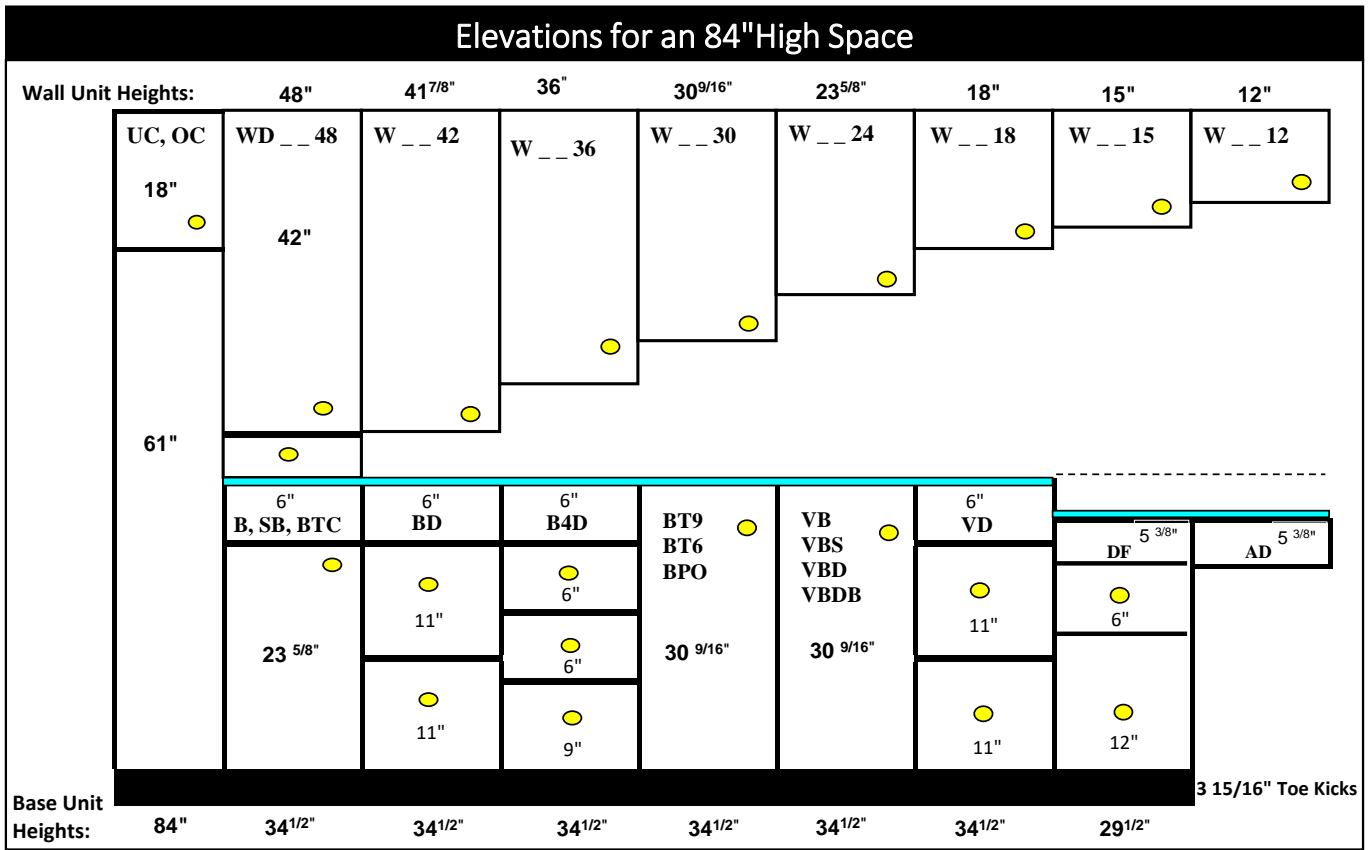

Specifications: Dimensional Specifications

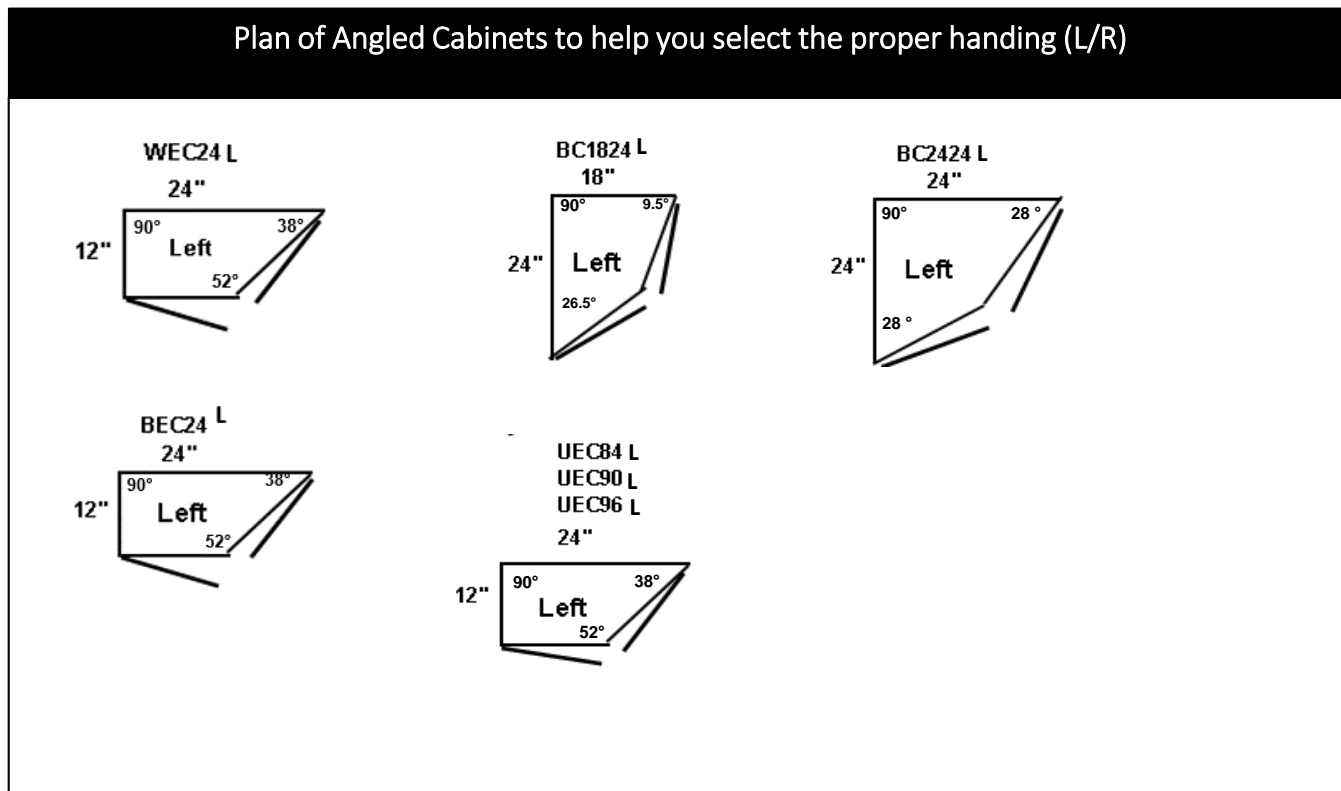
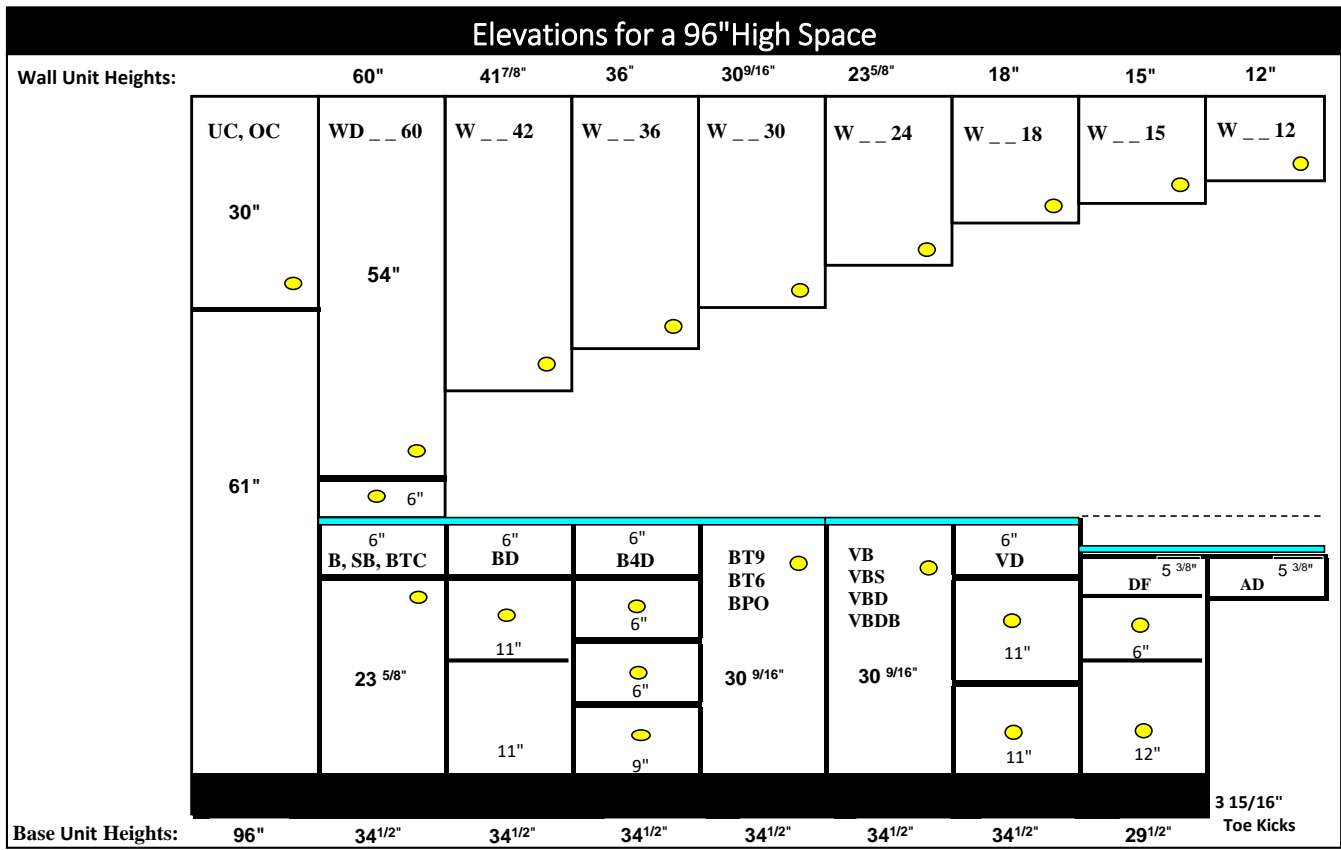

Specifications: Cabinet Construction - Full Access (Frameless)

Backs

- 5.5 mm thick **fibrex*** painted natural maple wood-grain

Fibrex is a High Density Fiberboard (HDF) reinforced panel set into end panels, secured with adhesive and clamped under pressure, ensuring square construction.

Finished End Panels

- 5/8" thick furniture-board low pressure laminate
- Exposed ends coordinates with door color
- Front is edge-banded to coordinates with door color
- Drilled to receive 8mm wood-dowels (top and bottom)
- Interiors are Natural Maple color wood grain laminate

Unfinished End Panels

- Unexposed ends are neutral color

Tops & Bottoms

- 3/8" thick furniture board laminated low pressure laminate
- Front Edge has horizontal face frame rail attached (1 7/8" high)

The Following Cabinets Are Full Access (Frameless) Construction:

Oven Cabinets (OC)	Base Lazy Susans (BLS)	Apron Drawers (AD)
Pantries and Utilities (UC)	Base Corner Susans (BCS)	Desk Files (DF and DDF)
Utility End Corners (UEC)	Base End Corner (BEC)	Vanity Linen (VL)
Wall End Corner (WEC)	Base Corner (BC)	Wine Rack Diagonal (WRD)*
Lift-Up Door Appliance Garage (WLIFT)	Base Pullout (BPO6)	* Does not use face frame rail

Specifications: Cabinet Construction - Framed

Face Frames

- 3/4" thick solid wood stiles and rails; joined with pocket screws
- Stiles are 1 1/8" wide; inside edge is beaded and outside edge radiused
- Rails are 1 7/8" wide inside edge is beaded and outside edge radiused

Backs

- 5.5 mm thick **fibrex*** painted natural maple wood-grain
- ***Fibrex is a High Density Fiberboard (HDF) reinforced panel set into end panels, secured with adhesive and clamped under pressure, ensuring square construction. ****

End Panels

- **Unexposed** end panels are 3/8" thick furniture-board; recessed a 1/4" from outside edge of face frame.
- Exterior face of end panel is laminated with a low pressure laminate.
- Interior face of end panel is laminated with a low pressure laminate in natural maple wood grain.
- **Exposed** end panels are 5/8" thick furniture-board; semi-flush with outside edge of face frame.
- Exterior face of end panel is low pressure laminate coordinating with door color.
- Interior face of end panel is low pressure laminate in Natural Maple color wood grain.

Tops & Bottoms

Wall Cabinets

- 3/8" thick furniture-board low pressure laminate with Natural Maple wood-grain on both sides.
- Dadoed and glued into the end panels and face-frame.

Base Cabinets

- Bottoms -- 3/8" thick furniture-board with low pressure laminate.
- Dadoed and glued into the end panels and face frame.
- Tops -- 3/8" Thick Plywood Vertical Construction Braces

Toekicks

- Separately constructed; glued and stapled to the cabinet.
- Constructed of 5/8" thick MDF or furniture board.
- On finished cabinet ends, the toekick is recessed in 2".
- On nonfinished cabinet ends, toe kick is recessed in 3/8".
- **TKC8** must be ordered to give a seamless finish in field.

Shelves

Carriage House Series

- 3/4" thick furniture-board low pressure laminate; with beaded wood edge.
- **Bradford, Coventry & Manchester Door Styles Use Gatehouse Shelf****

Gatehouse Series

- 3/4" thick furniture-board laminated low pressure laminate; with PVC edge-banding.

Specifications: Cabinet Construction - Framed (All Wood Construction)

Face Frames

- 3/4" thick solid wood stiles and rails; joined with pocket screws.
- Stiles are 1 1/8" wide; inside edge is beaded and outside edge radiused.
- Rails are 1 7/8" wide inside edge is beaded and outside edge radiused.

Backs

- 5.5 mm thick prefinished wood veneer with an MDF core.

End Panels (Carriage House)

- **Unexposed** end panels are 1/2" thick plywood; recessed a 1/8" from outside edge of face frame.
 - Exterior face of end panel is laminated with an unfinished wood veneer inner plies and MDF cross-bands.
 - Interior face of end panel is laminated with a prefinished wood veneer inner plies and MDF cross-bands.
 - **Exposed** end panels are 5/8" thick plywood; semi flush with outside edge of face frame.
 - Exterior face of end panel is laminated with a wood veneer inner plies and MDF cross-bands. A matching stain or paint color is applied to MDF or wood veneer.
 - Interior face of end panel is laminated with a prefinished wood veneer inner plies and MDF cross-bands.
- ***NOTE: Bradford, Coventry & Manchester Door Styles use Gatehouse Specifications***

End Panels (Gatehouse)

- **Unexposed** end panels are 1/2" thick plywood; recessed a 1/8" from outside edge of face frame.
- Exterior face of end panel is laminated with an unfinished wood veneer.
- Interior face of end panel is laminated with a prefinished wood veneer.
- **Exposed** end panels are 1/2" thick plywood; recessed a 1/8" from outside edge of face frame. Back of frame is unfinished.
- Exterior face of end panel is laminated with a wood veneer in the matching stain or paint color.
- Interior face of end panel is laminated with a wood veneer.

Tops & Bottoms

Wall Cabinets

- 3/8" thick plywood laminated with a prefinished wood veneer on both sides.
- Dadoed and glued into the end panels and face-frame.

Base Cabinets

- Bottoms -- 3/8" thick plywood prefinished wood veneer.
- Dadoed and glued into the end panels and face frame.
- Tops -- 3/8" thick plywood Vertical Construction Braces.

Toekicks

- Separately constructed; then glued and stapled to the cabinet.
- Constructed of 1/2" - 5/8" thick plywood.
- On finished cabinet ends, the toekick is recessed in 2".
- On unfinished cabinet ends, the toekick is recessed 1/2".
- **TKC8** must be ordered to give a seamless finish in field.

Shelves

Carriage House Series

- 3/4" thick plywood laminated with a prefinished wood veneer on both sides; with beaded wood edge.
- **Bradford, Coventry & Manchester Door Styles Use Gatehouse Shelf****

Gatehouse Series

- 3/4" thick plywood laminated with a prefinished wood veneer; with prefinished wood veneer edge banding.

Specifications: Cabinet Construction - Drawers and Pullouts

****Bradford, Coventry & Manchester Door Styles use Gatehouse UPGRADED (DTG) Drawer Features****

DRAWER FEATURES	GATEHOUSE	CARRIAGE HOUSE
BASE CABINET <i>Top Drawer</i>	21" Deep 5/8" Thick Plywood 4-Sided / 1/4" Plywood Bottom 3/4" Extension Side Mount Glides	21" Deep 3/4" Thick Dovetail - Plywood Sides Full Extension Undermount Soft Close Glides
BASE CABINET <i>Deep Drawers</i>	21" Deep 5/8" Thick Plywood 4-Sided / 1/4" Plywood Bottom 3/4" Extension Side Mount Glides	21" Deep 3/4" Thick Dovetail - Plywood 4-Sided Full Extension Undermount Soft Close Glides
VANITY CABINET <i>Top Drawer</i>	18" Deep 5/8" Thick Plywood 4-Sided / 1/4" Plywood Bottom 3/4" Extension Side Mount Glides	18" Deep 3/4" Thick Dovetail - Plywood Sides Full Extension Undermount Soft Close Glides
VANITY CABINET <i>Deep Drawers</i>	18" Deep 5/8" Thick Plywood 4-Sided / 1/4" Plywood Bottom 3/4" Extension Side Mount Glides	18" Deep 3/4" Thick Dovetail - Plywood Sides Full Extension Undermount Soft Close Glides
DESK FILE <i>Top Drawer</i>	18" Deep 5/8" Thick Plywood 4-Sided / 1/4" Plywood Bottom 3/4" Extension Side Mount Glides	18" Deep 3/4" Thick Dovetail - Plywood Sides Full Extension Undermount Soft Close Glides
DESK FILE <i>Deep Drawers</i>	20" Deep 5/8" Thick Plywood 4-Sided / 1/4" Plywood Bottom Full Extension Undermount Glides	20" Deep 3/4" Thick Dovetail - Plywood 4-Sided Full Extension Undermount Soft Close Glides

UPGRADE OPTION ONLY
3/4" Thick Dovetail (Front Only) - Plywood Sides
Full Extension Undermount Soft Close Glides

DRAWER FEATURES	GATEHOUSE	CARRIAGE HOUSE
OVEN CABINET	21" Deep 5/8" Thick Plywood 4-Sided / 1/4" Plywood Bottom 3/4" Extension Side Mount Glides	21" Deep 3/4" Thick Dovetail - Plywood Sides Full Extension Undermount Soft Close Glides
PULL OUT TRAYS	<p>UPGRADE OPTION ONLY 21" Deep (Non-Dovetailed) 5/8" Thick Plywood Sides 3/4" Thick Solid Wood Front 3/4" Extension Side Mount Glides</p>	<p>21" Deep (Non-Dovetailed) 5/8" Thick Plywood Sides 3/4" Thick Solid Wood Front 3/4" Extension Side Mount Glides</p> <p>UPGRADE OPTION ONLY 21" Deep 3/4" Thick Dovetail - Plywood Sides Full Access Undermount Soft Close Glides</p>

Specifications: Cabinet Construction - Cabinet Modification Options

Century does not finish the sides of the cabinets unless specified by the customer. Therefore, when ordering product, you MUST designate all finished ends, and these are an additional charge.

Standard End	<ul style="list-style-type: none"> Unfinished 3/8" furniture grade particle board with white low pressure laminate on exterior and natural maple color low pressure laminate on interior.
Finished End	<ul style="list-style-type: none"> Finished ends are 5/8" thick, constructed with coordinating veneer low pressure laminate panels. The end panel is semi flush with the faceframe.

- VR** **Finish Right Side**
- VL** **Finish Left Side**
- VV** **Finish Both Sides**
- [No designation]** - both sides are unfinished

***The following cabinets come standard with unfinished ends and cannot be ordered with finished end option.**

- | | | |
|-----------|------------|-----------|
| BEC24 L/R | BC1824 L/R | UEC84 L/R |
| BCS33 L/R | BC2424 L/R | UEC90 L/R |
| BCS36 L/R | BLS33 L/R | UEC96 L/R |
| | BLS36 L/R | BC45 |

Plywood End Options	<ul style="list-style-type: none"> Unexposed ends are 1/2" thick; exterior is unfinished and interior is finished in natural wood Exposed ends are 1/2" for GHS, 5/8" thick for CHS, exterior is finished in matching wood veneer and interior is finished in natural wood All exposed ends must be tagged with VR / VL / VV (Finished End Code) Each item on your order must be tagged with the manufacture code PLY to receive the Plywood End Option.
----------------------------	---

End Panel Door (EPDR)	<ul style="list-style-type: none"> End Panel Doors (EPDR) are optional decorative doors that can be applied to the cabinet ends to create a more finished look. They are wider than standard doors and made to meet the side edge of the doors on the front of the cabinet and cover the face frame. All exposed ends must be tagged with VR / VL / VV (Finished End Code) Order the appropriate sized End Panel Door (EPDR) code as a separate line item <p>See pages 108-109 for the End Panel Door (EPDR) Sizes and Specifications</p>
------------------------------	---

Specifications: Cabinet Construction - Cabinet Modification Options

Cabinet Box Modification Codes	
Code	Description
BOX	Box (No doors or drawer heads or hinges)
364	Box Only (No drawers/pullouts/doors/dheads/shelves/hinges)
BOB	Box Only (No drawers/pullouts/doors/dheads/shelves/hinges) with bead board back
PLY	Plywood Sides
AWB	All Wood Box
ES	Exton Stock

Cabinet Component Modification Codes	
Code	Description
BB	Beaded Back Only offered on cabinets that have finished interior. NOT available on angled cabinets
TKA	Toekick Add-On
NTK	No Toekick Assembly
TTD	Tall Tray Dividers (Must order individual divider trays) **Offered on 96" and Taller Cabinetry and 24" Deep Tall Cabinetry **Not Offered in Gatehouse Series or CHS "Value" Series

Drawer / Pullout Modification Codes	
Code	Description
DTG	Dovetail Drawer Core/Full Extension Soft Close Glides **This option is offered for Gatehouse Series Only. Not offered on base pull-outs (GPO)
GPO	Pullout instead of half shelf in Gatehouse Series **This option is offered for Gatehouse Series Only. 21" deep pullout (Middle position only)
FAP	Full Access Pullout **Only available for middle position pullouts. ** Not Available in Gatehouse Series or CHS "Value" Series
NPO	No Pullout ** Not Available in Gatehouse Series or CHS "Value" Series

Door / Drawer Front Modification Codes	
Code	Description
SCH	Soft Close Door Hinges **This option is offered for Gatehouse Series Only
RGL	Reeded Glass in lieu of Flat Glass on WG/WM Cabinets
NGL	No Glass inserts in doors for Glass or Mullion Cabinets
PN	Panel - Door will not be drilled for hinges and will only receive paint or stain- no topcoat
L2	Left Handed Door - 2 hinge Drillings
L3	Left Handed Door - 3 hinge Drillings
R2	Right Handed Door - 2 hinge Drillings
R3	Right Handed Door - 3 hinge Drillings
CD	Door that attaches to the cabinet Use this code when ordering Door for BLS or BCS cabinet
DD	Door that attaches to the door Use this code when ordering Door for BLS or BCS cabinet

Specifications: Terms & Policies

LEAD TIMES/CHANGE ORDERS/CANCELLATIONS

STANDARD ORDERS (4 week lead times plus delivery) - Century provides a two (2) day time period from date of order acknowledgement to change/cancel order. After that time, it will be locked into production. Subsequent changes or cancellation of the order will result in:

- **WEEK 1 – 25% CHARGE FOR WORK IN PROGRESS**
- **WEEK 2 – 50% CHARGE FOR WORK IN PROGRESS**
- **WEEK 3 & 4 – 100% CHARGE FOR WORK IN PROGRESS**

SHORT-LEAD WAIVER (3 week lead times plus delivery) - Century provides zero (0) day time period from date of order acknowledgement to change/cancel an order. The order is immediately processed, released, and locked into production. Changes or cancellation of the order will result in:

- **WEEK 1 – 25% CHARGE FOR WORK IN PROGRESS**
- **WEEK 2 – 50% CHARGE FOR WORK IN PROGRESS**
- **WEEK 3 – 100% CHARGE FOR WORK IN PROGRESS**

TERMS AND CONDITIONS OF SALE

- 1) 50% DEPOSIT is required to process all orders over \$10,000 for C.I.A. (Cash In Advance) customers. Orders less than \$10,000 are required to be paid in full. Century accepts bank checks, personal checks, and most major credit cards. Century will not hold or accept post dated checks. \$50 service charge will be applied for checks returned from bank for Non-Sufficient Funds. Balance is due 5 BUSINESS DAYS prior to delivery. If not paid, delivery will be cancelled and not re-scheduled until balance is paid in full.
- 2) Ship date on order acknowledgement is TENTATIVE. Customer will be advised of ship date approximately 1 week prior to the date on the order. Material held after 30 days from ship date may be disposed of and deposit forfeited or a storage fee of \$100 per week will be added to the balance.
- 3) Delivery must be cancelled 5 working days before delivery or a charge of \$100 will be applied to deliver cabinets on the next scheduled day.
- 4) Customer or authorized representative must be present at delivery site to sign for merchandise. Deliveries unable to be made will incur an additional \$350 charge and applied to re-scheduled delivery.
- 5) It is the buyers responsibility, at time of delivery, to verify quantities received, inspect cartons for visible damage, sign and date shipping tickets.
- 6) Claims for shortages, errors, and damages must be noted on shipping ticket at time of delivery. Concealed damages must be reported to your Century Sales Representative/Administrator within 1 week of shipment.
- 7) Cabinetry is NOT RETURNABLE unless defective. Defective items need to be returned within 30 days of delivery uninstalled and in original box. Stocked accessories may be returned with a 35% restocking fee. Returned accessories must be in good condition or no credit will be issued.
- 8) Installation and adjustment of merchandise is the responsibility of the customer.
- 9) Century Cabinetry has a 10-year limited warranty, effective as of 4/1/12. Century Cabinetry will repair or replace any material that proves defective. Claims for labor installation cost will NOT be accepted.

Specifications: Warranty Information

10 Year Limited Warranty

Century Cabinetry, Inc. warrants its products to be free from defects in material or workmanship under normal use for a period of 10 years from date of purchase by the original consumer purchaser and is not transferrable to subsequent homeowners. Should defects in material or workmanship arise during this warranty period, Century Cabinetry, Inc. will replace or repair, at its discretion, the defective cabinet, material or component.

This warranty does not cover products that are misused, abused, neglected, modified, improperly stored, incorrectly installed, or subjected to extremes in moisture or temperature.

This warranty covers only parts and materials of the products manufactured by Century Cabinetry, Inc.. Not covered under this warranty are countertops, appliances, plumbing fixtures, etc or the costs (including labor) to remove or re-install materials or related items such as plumbing fixtures, countertops, appliances...

Wood Disclaimer

Variations in color and grain are a natural characteristic of wood. Changes in color on finished wood products can occur due to exposure to light and other environmental factors. These variations and color changes are not deemed defective and therefore are not covered under this warranty.

Finishes/Glazes/Distressing

Variations in Century Cabinetry's hand applied finishes and glazes are what give each piece its distinctive look and these variations are not considered to be defects in material or workmanship.

Changes to Finishes or Product Design

Century Cabinetry may modify product due to supplier availability and as changes or improvements are implemented, but is under no obligation to make these changes to previously manufactured product.

If a warranty claim is filed after a product or finish becomes obsolete, Century Cabinetry reserves the right to honor the warranty in the following ways:

- a. To replace the affected component with a new component of the same style
- b. To replace the affected component with any other component(s) to achieve a similar appearance with a style that is comparable in appearance, color, design or construction based upon current product offerings.

If components are replaced, Century Cabinetry cannot guarantee that the finish of these items will be an exact match to the finish and appearance of the original purchased components.

Implied Warranties

This warranty is only valid in the United States of America. To the extent permitted by law, any implied warranties, including the implied warranties of merchantability and fitness for a particular purpose, are limited to the duration of this express warranty. This warranty excludes any incidental or consequential damages. Some states do not allow limitations on how long an implied warranty lasts, so the above limitations may not apply to you.

Making a Claim

To make a claim under this warranty, the purchaser must contact their local Century dealer or distributor and report said defects. If you have difficulty obtaining assistance write to: Century Cabinetry Inc. 220 Phillips Road Exton, PA 19341. Attn: Customer Warranty/Service Department. To ensure timely processing, please include your name, phone number, builder or contractor name, lot number, address, city, state, and zip code.

Warranty Effective Date

This warranty is effective as of April 1, 2012 and covers all cabinets ordered on or after this date.

THIS WARRANTY IS THE EXCLUSIVE WARRANTY OF CENTURY CABINETRY AND IS IN LIEU OF ALL OTHER WARRANTIES, EITHER EXPRESSED OR IMPLIED. IN NO EVENT SHALL CENTURY CABINETRY BE LIABLE FOR CONSEQUENTIAL, INDIRECT OR INCIDENTAL DAMAGES RESULTING FROM THE INSTALLATION, USE OR FAILURE OF ITS PRODUCT.

Care & Cleaning Guidelines

The solid wood and wood veneer components used in the manufacture of your cabinets are finished with a Water-Based UV Finish, which will hold up to continuous use for many years. The materials used in the finishing process are especially designed to meet industry performance standards for resistance to moisture, grease, soap, detergents, and food stains. The following guidelines and suggestions should help keep your cabinetry looking beautiful for many years.

General Cleaning and Care of Wood Cabinets

Remove any oil, grease, or soil, using a clean damp cloth of mild soap and water. Rinse with a clean damp cloth. Dry thoroughly with a soft lint-free cloth. DO NOT use steel wool, soap pads, polishing wax or cleaners containing bleach, ammonia, harsh detergents, and abrasives. All of these can remove the factory-applied finish and thus void warranty.

Routine cleaning can help prevent permanent damage from build up of grease and smoke.

Excess moisture can also damage cabinets. The most common areas for moisture build-up are around the sink, range, dishwasher, oven, and baseboard. Immediately dry surfaces with a clean cloth.

Over time cabinet finish may either darken or lighten depending upon lighting. This is normal.

To repair nicks and scratches

Use a matching Touch Up Marker which is designed to match the cabinet finish. If you do not have one, please contact your Century Cabinetry dealer.

Apply the touch up marker over the scratched area and wipe away the excess with a clean soft cloth. Never use sand paper or any other material to even out a scratch, as it will damage the finish.

Care of Cabinet Interiors

Century Cabinetry's shelves are made of low pressure laminate which is a material that is resistant to scratches, stains, and water penetration

To remove food residue or grease, use any common dishwashing liquid (not detergent) or a solution of mild soap and water. Wipe clean with a clean soft damp cloth and dry thoroughly. Wipe up spills and dry immediately.

Self-Cleaning Ovens

Self-cleaning ovens are cleaned through the use of intense heat. If the heat gasket does not seal properly, heat may escape from the oven. Cabinet components installed near the oven may suffer finish or surface damage.

To minimize risk of damage during cleaning cycles, we recommend that you remove doors and drawers from cabinets that are above and adjacent to a self-cleaning oven.

Specifications: Industry Qualifications

Century Cabinetry is committed to conducting our business in an environmentally responsible manner. Our commitment to environmental awareness and preservation is reflected throughout our business. Century's cabinetry is manufactured using environmentally friendly practices.

KCMA Certified



Century Cabinetry has been certified by the Kitchen Cabinet Manufacturers Association (KCMA) as meeting the standards for their Environmental Stewardship Program (ESP). Our organization is committed to meeting and further exceeding the standards as set forth by the leaders in our industry. Visit WWW.KCMA.ORG for more information.

CARB II Compliant

California Air Resources Board (CARB) continues in the development of innovative air pollution control strategies. CARB II is the toughest standard in the world for formaldehyde emission levels from composite wood panels. Century Cabinetry products are CARB II compliant. Visit WWW.ARB.CA.GOV for more information.

WATER BASE UV Finishing

In 2008, Century completed a Finishing System Modernization program committed to environmentally safe processes. Stains and Finishes were converted to Water-Base UV thereby virtually eliminating hazardous air pollutants (HAPS) and off-gassing odors and greatly reducing volatile organic compounds (VOC). Material is also formulated without heavy metals and are formaldehyde free. These standards provide a healthy product for your home while protecting and conserving our land and natural resources.

LEADERSHIP IN ENERGY ENVIRONMENTAL DESIGN (LEED)

LEED is a nationally accepted benchmark for the design, construction and operation of high-performance green buildings. The LEED certification program is run under the guidance of the US Green Building Council (USGBC). Please visit WWW.USGBC.ORG for more information. Century Cabinetry can provide cabinets to fulfill most of your LEED project requirements.

Specifications: Custom Item Form

Reset Form

Please Fax To:
610-363-5409
Attn: Production Manager



rev: 05-23-13

Custom Item Worksheet

Please submit this form for approval and quote from Century Cabinetry

Century Cabinetry recommends that you obtain approval prior to committing to your customer that this custom option is available. Please allow 3 days for a response.

Please include the following details:

Customer Name: _____ Date: _____
Project Name: _____ Lot# /Tag: _____

Product Series:

Door Style: _____ Finish: _____ GHS CHS EURO

Description of Request:

Please provide a drawing:

Width _____ Height _____ Depth _____

APPROVED:

YES Approved By: _____ Date: _____
 NO Total List Price: _____ Extra Lead Time Required: _____ Weeks
Approval Code: _____

Email to Century Production Manager

TAB: Doors & Finishes

- **Wood Species Information**
- **Finish Information**
- **Finish Availability Chart**
 - Gatehouse
 - Carriage House
- **Door Style Quick Reference**
 - Gatehouse
 - Carriage House
- **Door Styles**
 - Gatehouse (Including Glass/Mullion Styles)
 - Carriage House (Including Glass/Mullion Styles)

Doors & Finishes: Wood Species Information

Wood is a natural material that has inherent variations in its graining and color. Because of this, each piece of wood or veneer accepts stain differently. This is part of what contributes to the unique beauty of wood. In addition, color difference or changes in the wood can occur over time with exposure to sunlight, harsh chemicals, smoke, and extreme heat or moisture. These are important characteristics of wood that should be taken into consideration. Additional information pertaining to each specific type of wood species is listed below.



Cherry is a close-grained hardwood with rich, varying colors ranging from light pink to deep browns. undulating waves and curls in the grain are natural and desirable qualities found in this wood. As Cherry ages, the wood becomes darker and this is especially apparent when exposed to direct sunlight. Other naturally occurring characteristics of this elegant wood include pin knots and mineral streaks.



Maple has a smooth, even texture and is a more uniformed close-grained wood. Its natural colors range from a creamy white to dark reddish-brown tones. This varying palette can occur within a single door. Maple may contain mineral streaks, wavy or curly graining, and fine brown lines; all of which are acceptable characteristics of Maple's natural beauty.



MDF, or Medium-Density Fiberboard, is an extremely stable wood composite material made from wood fibers and resin. Because of its inherent stability, it's ideal for painted doors and drawer fronts. It is resistant to changes in heat and humidity unlike painted wood doors which are very susceptible to contracting & expanding. MDF painted doors create a beautiful look with a long lasting, durable finish.

STAIN

Our cabinets are finished with a premium water-based UV cured finish. It is environmentally friendly and provides excellent durability and performance. The lusturious finish enhances the natural grain of the woods while providing a consistent, elegant appearance, even with darker stains. Because it is a UV-cured finish, the color will less likely fade over time which helps to maintain the beauty of your investment.

PAINT

Our paint finishes are also water-based UV cured finishes, with the same eco-friendliness and performance. It is a durable, opaque color that emphasizes and accentuates the rich detailing of each door. It also will less likely fade over time and maintain a consistent, elegant look to the cabinetry.

GLAZES*

Glazes are a hand applied finish that accentuates the unique detailing on the doors and drawer fronts. It collects in the corners, grooves, and recesses and because of this, the overall look varies from subtle to dramatic based on the door style selected. Face frames, ends, panels, and selected moldings will not receive glazing. Some slab drawer fronts will not receive any glazing due to the lack of detail. For further clarification please contact your rep. or designer.

DISTRESSING*

Distressing is offered in two colors: Black Distressed and Walnut Black Distressed.

Walnut Black Distressed feature hand applied distressing characteristics like bird pecks and scratches meant to replicate an aged look. This is further accentuated by the addition of glazing which highlights the appealing imperfections.

Black Distressed feature a sandthrough technique which exposes the underlying panel and replicates a time-worn effect.

**** Specialty finish techniques in particular will vary within individual doors and throughout the entire room. It is recommended that a sample door and drawer front be ordered to illustrate the unique characteristics inherent within each finish. Inconsistencies should be expected and are acceptable qualities featured in the specialty finishes.***

Doors & Finishes: Gatehouse Finish Availability Chart

DOOR STYLES	STAINS					PAINTS				PAINTS w/ GLAZE					SPECIALTY FINISHES											
	AUBURN	ESPRESSO	PEWTER	SAND	WALNUT	ARCTIC	GRAY	SILVER	WHITE	WILLOW	ARCTIC BLACK						BLACK DISTRESSED	WALNUT BLACK DISTR.								
GATEHOUSE																										
BROOKFIELD MAPLE	•	•		•	•																					
BROOKFIELD PAINT							•		•	•																
CLEARBROOK MAPLE	•	•		•	•																					
CLEARBROOK PAINT							•		•	•																
MISSION MAPLE	•	•		•	•																					
MISSION PAINT							•		•	•																

Doors & Finishes: Carriage House Finish Availability Chart

DOOR STYLES	STAINS					PAINTS							PAINTS w/GLAZE		SPECIALTY FINISHES																
	AUBURN	ESPRESSO	PEWTER	SAND	WALNUT	ARCTIC	BLUE	BLACK	GRAY	SILVER	STONE	WHITE	WILLOW	VERDE	ARCTIC BLACK	BLACK DISTRESSED	WALNUT BLACK DISTR.														
CARRIAGE HOUSE																															
ANNANDALE CHERRY																															
ANNANDALE MAPLE																															
ANNANDALE PAINT																															
ARLINGTON CHERRY																															
ARLINGTON MAPLE																															
ARLINGTON PAINT																															
AVALON CHERRY																															
AVALON MAPLE																															
AVALON PAINT																															
BERMUDA PAINT																															
BRADFORD MAPLE																															
BRADFORD PAINT																															
CHARLESTOWN CHERRY																															
CHARLESTOWN MAPLE																															
CHARLESTOWN PAINT																															
COVENTRY MAPLE																															
COVENTRY PAINT																															
ELITE PAINT																															
FOXWOOD CHERRY																															
FOXWOOD MAPLE																															
FOXWOOD PAINT																															
HAMPTON PAINT																															
JAMESTOWN CHERRY																															
JAMESTOWN MAPLE																															
JAMESTOWN PAINT																															
LANCASTER CHERRY																															
LANCASTER MAPLE																															
LANCASTER PAINT																															
MALIBU CHERRY																															
MALIBU MAPLE																															
MALIBU PAINT																															
MANCHESTER MAPLE																															
MANCHESTER PAINT																															
MILAN CHERRY																															
MILAN MAPLE																															
MILAN PAINT																															
MONACO CHERRY																															
MONACO MAPLE																															
MONACO PAINT																															
RITTENHOUSE CHERRY																															
RITTENHOUSE MAPLE																															
RITTENHOUSE PAINT																															
VENICE PAINT																															
WENTWORTH CHERRY																															
WENTWORTH MAPLE																															
WENTWORTH PAINT																															
YARDLEY CHERRY																															
YARDLEY MAPLE																															
YARDLEY PAINT																															

Doors & Finishes: Gatehouse Quick Reference

STYLE NAME	CODE	PRICE COLUMN	SPECIES	CENTER PANEL	DRAWER HEAD
BROOKFIELD					
MAPLE AUBURN	BR	D	MAPLE	VENEER RAISED	SLAB
MAPLE ESPRESSO	BP	D	MAPLE	VENEER RAISED	SLAB
MAPLE SAND	BD	D	MAPLE	VENEER RAISED	SLAB
MAPLE WALNUT	BE	D	MAPLE	VENEER RAISED	SLAB
PAINT GRAY	BH	D	MDF	SOLID RAISED	SLAB
PAINT WHITE	BW	D	MDF	SOLID RAISED	SLAB
PAINT WILLOW	BU	D	MDF	SOLID RAISED	SLAB
CLEARBROOK					
MAPLE AUBURN	CR	B	MAPLE	RECESSED	SLAB
MAPLE ESPRESSO	CP	B	MAPLE	RECESSED	SLAB
MAPLE SAND	CD	B	MAPLE	RECESSED	SLAB
MAPLE WALNUT	CL	B	MAPLE	RECESSED	SLAB
PAINT GRAY	CG	B	MDF	RECESSED	SLAB
PAINT WHITE	CW	B	MDF	RECESSED	SLAB
PAINT WILLOW	CI	B	MDF	RECESSED	SLAB
MISSION					
MAPLE AUBURN	MA	C	MAPLE	RECESSED	FLAT
MAPLE ESPRESSO	MP	C	MAPLE	RECESSED	FLAT
MAPLE SAND	MD	C	MAPLE	RECESSED	FLAT
MAPLE WALNUT	MU	C	MAPLE	RECESSED	FLAT
PAINT GRAY	MG	C	MDF	RECESSED	FLAT
PAINT WHITE	MW	C	MDF	RECESSED	FLAT
PAINT WILLOW	MI	C	MDF	RECESSED	FLAT

Doors & Finishes: Carriage House Quick Reference

STYLE NAME	CODE	PRICE COLUMN	SPECIES	CENTER PANEL	DRAWER HEAD
ANNANDALE					
CHERRY AUBURN	DA	G	CHERRY	RECESSED	1 PC. RAISED
CHERRY WALNUT	NE	G	CHERRY	RECESSED	1 PC. RAISED
CHERRY WALNUT BLACK DISTRESSED	NY	K	CHERRY	RECESSED	1 PC. RAISED
MAPLE AUBURN	NR	F	MAPLE	RECESSED	1 PC. RAISED
MAPLE ESPRESSO	NP	F	MAPLE	RECESSED	1 PC. RAISED
MAPLE PEWTER	DN	G	MAPLE	RECESSED	1 PC. RAISED
MAPLE SAND	NG	F	MAPLE	RECESSED	1 PC. RAISED
MAPLE WALNUT	AY	F	MAPLE	RECESSED	1 PC. RAISED
PAINT ARCTIC	DR	G	MDF	RECESSED	1 PC. RAISED
PAINT ARCTIC BLACK	DL	J	MDF	RECESSED	1 PC. RAISED
PAINT BLACK	RF	J	MDF	RECESSED	1 PC. RAISED
PAINT BLACK DISTRESSED	DI	K	MDF	RECESSED	1 PC. RAISED
PAINT BLUE	PG	G	MDF	RECESSED	1 PC. RAISED
PAINT GRAY	DJ	F	MDF	RECESSED	1 PC. RAISED
PAINT SILVER	D8	G	MDF	RECESSED	1 PC. RAISED
PAINT STONE	DB	G	MDF	RECESSED	1 PC. RAISED
PAINT VERDE	6A	G	MDF	RECESSED	1 PC. RAISED
PAINT WHITE	DW	F	MDF	RECESSED	1 PC. RAISED
PAINT WILLOW	DK	F	MDF	RECESSED	1 PC. RAISED
ARLINGTON					
CHERRY AUBURN	RA	H	CHERRY	SOLID RAISED	1 PC. RAISED
CHERRY WALNUT	NH	H	CHERRY	SOLID RAISED	1 PC. RAISED
CHERRY WALNUT BLACK DISTRESSED	LG	L	CHERRY	SOLID RAISED	1 PC. RAISED
MAPLE AUBURN	LR	G	MAPLE	SOLID RAISED	1 PC. RAISED
MAPLE ESPRESSO	LP	G	MAPLE	SOLID RAISED	1 PC. RAISED
MAPLE PEWTER	GE	H	MAPLE	SOLID RAISED	1 PC. RAISED
MAPLE SAND	LB	G	MAPLE	SOLID RAISED	1 PC. RAISED
MAPLE WALNUT	LD	G	MAPLE	SOLID RAISED	1 PC. RAISED
PAINT ARCTIC	LC	H	MDF	SOLID RAISED	1 PC. RAISED
PAINT ARCTIC BLACK	GF	K	MDF	SOLID RAISED	1 PC. RAISED
PAINT BLACK	RC	K	MDF	SOLID RAISED	1 PC. RAISED
PAINT BLACK DISTRESSED	BL	L	MDF	SOLID RAISED	1 PC. RAISED
PAINT BLUE	PT	H	MDF	SOLID RAISED	1 PC. RAISED
PAINT GRAY	RZ	G	MDF	SOLID RAISED	1 PC. RAISED
PAINT SILVER	D9	H	MDF	SOLID RAISED	1 PC. RAISED
PAINT STONE	RG	H	MDF	SOLID RAISED	1 PC. RAISED
PAINT VERDE	6B	H	MDF	SOLID RAISED	1 PC. RAISED
PAINT WHITE	RW	G	MDF	SOLID RAISED	1 PC. RAISED
PAINT WILLOW	LF	G	MDF	SOLID RAISED	1 PC. RAISED
AVALON					
CHERRY AUBURN	VB	H	CHERRY	RECESSED	MATCHING
CHERRY WALNUT	VJ	H	CHERRY	RECESSED	MATCHING
CHERRY WALNUT BLACK DISTRESSED	XV	L	CHERRY	RECESSED	MATCHING
MAPLE AUBURN	VR	G	MAPLE	RECESSED	MATCHING
MAPLE ESPRESSO	VP	G	MAPLE	RECESSED	MATCHING
MAPLE PEWTER	PZ	H	MAPLE	RECESSED	MATCHING
MAPLE SAND	VK	G	MAPLE	RECESSED	MATCHING
MAPLE WALNUT	VO	G	MAPLE	RECESSED	MATCHING
PAINT ARCTIC	VZ	H	MDF	RECESSED	MATCHING
PAINT BLACK	VU	H	MDF	RECESSED	MATCHING
PAINT BLUE	PV	H	MDF	RECESSED	MATCHING
PAINT GRAY	VG	G	MDF	RECESSED	MATCHING
PAINT SILVER	EG	H	MDF	RECESSED	MATCHING
PAINT STONE	VL	H	MDF	RECESSED	MATCHING
PAINT VERDE	6C	H	MDF	RECESSED	MATCHING
PAINT WHITE	VW	G	MDF	RECESSED	MATCHING
PAINT WILLOW	VY	G	MDF	RECESSED	MATCHING

Doors & Finishes: Carriage House Quick Reference

STYLE NAME	CODE	PRICE COLUMN	SPECIES	CENTER PANEL	DRAWER HEAD
BERMUDA					
PAINT ARCTIC BLACK	A4		MDF	BEADED RECESSED	SLAB/MATCHING
PAINT ARCTIC	A5	K	MDF	BEADED RECESSED	SLAB/MATCHING
PAINT BLACK	A6	L	MDF	BEADED RECESSED	SLAB/MATCHING
PAINT BLUE	A8	K	MDF	BEADED RECESSED	SLAB/MATCHING
PAINT GRAY	A9	J	MDF	BEADED RECESSED	SLAB/MATCHING
PAINT SILVER	B7	K	MDF	BEADED RECESSED	SLAB/MATCHING
PAINT STONE	B4	K	MDF	BEADED RECESSED	SLAB/MATCHING
PAINT VERDE	6D	J	MDF	BEADED RECESSED	SLAB/MATCHING
PAINT WHITE	B5	J	MDF	BEADED RECESSED	SLAB/MATCHING
PAINT WILLOW	B6	J	MDF	BEADED RECESSED	SLAB/MATCHING
BRADFORD					
MAPLE AUBURN	FJ	E	MAPLE	VENEER RAISED	FLAT
MAPLE ESPRESSO	FO	E	MAPLE	VENEER RAISED	FLAT
MAPLE SAND	FM	E	MAPLE	VENEER RAISED	FLAT
MAPLE WALNUT	FQ	E	MAPLE	VENEER RAISED	FLAT
PAINT GRAY	FY	E	MDF	SOLID RAISED	FLAT
PAINT SILVER	EH	F	MDF	SOLID RAISED	FLAT
PAINT WHITE	FI	E	MDF	SOLID RAISED	FLAT
PAINT WILLOW	KW	E	MDF	SOLID RAISED	FLAT
CHARLESTOWN					
CHERRY AUBURN	CU	K	CHERRY	SOLID RAISED	MATCHING
CHERRY WALNUT	CT	K	CHERRY	SOLID RAISED	MATCHING
CHERRY WALNUT BLACK DISTRESSED	1H	L	CHERRY	SOLID RAISED	MATCHING
MAPLE AUBURN	1K	J	MAPLE	SOLID RAISED	MATCHING
MAPLE ESPRESSO	CP	J	MAPLE	SOLID RAISED	MATCHING
MAPLE PEWTER	CR	K	MAPLE	SOLID RAISED	MATCHING
MAPLE SAND	1Q	J	MAPLE	SOLID RAISED	MATCHING
MAPLE WALNUT	HC	J	MAPLE	SOLID RAISED	MATCHING
PAINT ARCTIC	HX	K	MDF	SOLID RAISED	MATCHING
PAINT ARCTIC BLACK	HK	L	MDF	SOLID RAISED	MATCHING
PAINT BLACK DISTRESSED	CK	L	MDF	SOLID RAISED	MATCHING
PAINT BLACK	CM	L	MDF	SOLID RAISED	MATCHING
PAINT BLUE	CB	K	MDF	SOLID RAISED	MATCHING
PAINT GRAY	CG	J	MDF	SOLID RAISED	MATCHING
PAINT SILVER	EI	K	MDF	SOLID RAISED	MATCHING
PAINT STONE	HN	K	MDF	SOLID RAISED	MATCHING
PAINT VERDE	6E	K	MDF	SOLID RAISED	MATCHING
PAINT WHITE	LW	J	MDF	SOLID RAISED	MATCHING
PAINT WILLOW	CL	J	MDF	SOLID RAISED	MATCHING
COVENTRY					
MAPLE AUBURN	YA	D	MAPLE	RECESSED	FLAT
MAPLE ESPRESSO	YQ	D	MAPLE	RECESSED	FLAT
MAPLE SAND	YF	D	MAPLE	RECESSED	FLAT
MAPLE WALNUT	YK	D	MAPLE	RECESSED	FLAT
PAINT GRAY	YY	D	MDF	RECESSED	FLAT
PAINT SILVER	EM	E	MDF	RECESSED	FLAT
PAINT WHITE	YH	D	MDF	RECESSED	FLAT
PAINT WILLOW	YZ	D	MDF	RECESSED	FLAT

Doors & Finishes: Carriage House Quick Reference

STYLE NAME	CODE	PRICE COLUMN	SPECIES	CENTER PANEL	DRAWER HEAD
ELITE					
PAINT ARCTIC	FX	G	MDF	RECESSED	1 PC. RAISED
PAINT ARCTIC BLACK	TJ	J	MDF	RECESSED	1 PC. RAISED
PAINT BLACK	EF	J	MDF	RECESSED	1 PC. RAISED
PAINT BLUE	JV	G	MDF	RECESSED	1 PC. RAISED
PAINT GRAY	EB	F	MDF	RECESSED	1 PC. RAISED
PAINT SILVER	EN	G	MDF	RECESSED	1 PC. RAISED
PAINT STONE	ES	G	MDF	RECESSED	1 PC. RAISED
PAINT VERDE	6G	G	MDF	RECESSED	1 PC. RAISED
PAINT WHITE	EW	F	MDF	RECESSED	1 PC. RAISED
PAINT WILLOW	EY	F	MDF	RECESSED	1 PC. RAISED
FOXWOOD					
CHERRY AUBURN	1U	J	CHERRY	RECESSED	MATCHING
CHERRY WALNUT	2D	J	CHERRY	RECESSED	MATCHING
MAPLE AUBURN	2F	H	MAPLE	RECESSED	MATCHING
MAPLE ESPRESSO	2I	H	MAPLE	RECESSED	MATCHING
MAPLE PEWTER	2J	J	MAPLE	RECESSED	MATCHING
MAPLE SAND	2K	H	MAPLE	RECESSED	MATCHING
MAPLE WALNUT	5Q	H	MAPLE	RECESSED	MATCHING
PAINT ARCTIC	2O	J	MDF	RECESSED	MATCHING
PAINT ARCTIC BLACK	2N	K	MDF	RECESSED	MATCHING
PAINT BLACK DISTRESSED	2P	K	MDF	RECESSED	MATCHING
PAINT BLACK	2Q	K	MDF	RECESSED	MATCHING
PAINT BLUE	2R	J	MDF	RECESSED	MATCHING
PAINT GRAY	2U	H	MDF	RECESSED	MATCHING
PAINT SILVER	EO	J	MDF	RECESSED	MATCHING
PAINT STONE	2C	J	MDF	RECESSED	MATCHING
PAINT VERDE	6H	J	MDF	RECESSED	MATCHING
PAINT WHITE	2V	H	MDF	RECESSED	MATCHING
PAINT WILLOW	2X	H	MDF	RECESSED	MATCHING
HAMPTON					
PAINT ARCTIC	AZ	H	MDF	SOLID RAISED	1 PC. RAISED
PAINT ARCTIC BLACK	ZU	K	MDF	SOLID RAISED	1 PC. RAISED
PAINT BLACK	BF	K	MDF	SOLID RAISED	1 PC. RAISED
PAINT BLUE	PS	H	MDF	SOLID RAISED	1 PC. RAISED
PAINT GRAY	IB	G	MDF	SOLID RAISED	1 PC. RAISED
PAINT SILVER	ER	H	MDF	SOLID RAISED	1 PC. RAISED
PAINT STONE	HB	H	MDF	SOLID RAISED	1 PC. RAISED
PAINT VERDE	6I	H	MDF	SOLID RAISED	1 PC. RAISED
PAINT WHITE	HW	G	MDF	SOLID RAISED	1 PC. RAISED
PAINT WILLOW	ZW	G	MDF	SOLID RAISED	1 PC. RAISED

Doors & Finishes: Carriage House Quick Reference

STYLE NAME	CODE	PRICE COLUMN	SPECIES	CENTER PANEL	DRAWER HEAD
JAMESTOWN					
CHERRY AUBURN	MU	K	CHERRY	RECESSED	MATCHING
CHERRY WALNUT BLACK DISTRESSED	3E	L	CHERRY	RECESSED	MATCHING
CHERRY WALNUT	MT	K	CHERRY	RECESSED	MATCHING
MAPLE AUBURN	3H	J	MAPLE	RECESSED	MATCHING
MAPLE ESPRESSO	ME	J	MAPLE	RECESSED	MATCHING
MAPLE PEWTER	1P	K	MAPLE	RECESSED	MATCHING
MAPLE SAND	3K	J	MAPLE	RECESSED	MATCHING
MAPLE WALNUT	AF	J	MAPLE	RECESSED	MATCHING
PAINT ARCTIC	1F	K	MDF	RECESSED	MATCHING
PAINT ARCTIC BLACK	1Z	L	MDF	RECESSED	MATCHING
PAINT BLACK DISTRESSED	MD	L	MDF	RECESSED	MATCHING
PAINT BLACK	1M	L	MDF	RECESSED	MATCHING
PAINT BLUE	JT	K	MDF	RECESSED	MATCHING
PAINT GRAY	MG	J	MDF	RECESSED	MATCHING
PAINT SILVER	EU	K	MDF	RECESSED	MATCHING
PAINT STONE	JX	K	MDF	RECESSED	MATCHING
PAINT VERDE	6K	K	MDF	RECESSED	MATCHING
PAINT WHITE	AW	J	MDF	RECESSED	MATCHING
PAINT WILLOW	MW	J	MDF	RECESSED	MATCHING
LANCASTER					
CHERRY AUBURN	JA	J	CHERRY	RECESSED	MATCHING
CHERRY WALNUT	LX	J	CHERRY	RECESSED	MATCHING
MAPLE AUBURN	JF	H	MAPLE	RECESSED	MATCHING
MAPLE ESPRESSO	JJ	H	MAPLE	RECESSED	MATCHING
MAPLE PEWTER	JW	J	MAPLE	RECESSED	MATCHING
MAPLE SAND	JL	H	MAPLE	RECESSED	MATCHING
MAPLE WALNUT	JZ	H	MAPLE	RECESSED	MATCHING
PAINT ARCTIC	NX	J	MDF	RECESSED	MATCHING
PAINT ARCTIC BLACK	JS	K	MDF	RECESSED	MATCHING
PAINT BLACK	JO	K	MDF	RECESSED	MATCHING
PAINT BLUE	TY	J	MDF	RECESSED	MATCHING
PAINT GRAY	JR	H	MDF	RECESSED	MATCHING
PAINT SILVER	EZ	J	MDF	RECESSED	MATCHING
PAINT STONE	LN	J	MDF	RECESSED	MATCHING
PAINT VERDE	6K	J	MDF	RECESSED	MATCHING
PAINT WHITE	LH	H	MDF	RECESSED	MATCHING
PAINT WILLOW	LI	H	MDF	RECESSED	MATCHING
MALIBU					
CHERRY AUBURN	MA	J	CHERRY	RECESSED	SLAB/MATCHING
CHERRY WALNUT	PK	J	CHERRY	RECESSED	SLAB/MATCHING
MAPLE AUBURN	PF	H	MAPLE	RECESSED	SLAB/MATCHING
MAPLE ESPRESSO	PE	H	MAPLE	RECESSED	SLAB/MATCHING
MAPLE PEWTER	OT	J	MAPLE	RECESSED	SLAB/MATCHING
MAPLE SAND	ON	H	MAPLE	RECESSED	SLAB/MATCHING
MAPLE WALNUT	5C	H	MAPLE	RECESSED	SLAB/MATCHING
PAINT ARCTIC	OR	J	MDF	RECESSED	SLAB/MATCHING
PAINT BLACK	OM	K	MDF	RECESSED	SLAB/MATCHING
PAINT BLUE	OB	J	MDF	RECESSED	SLAB/MATCHING
PAINT GRAY	OG	H	MDF	RECESSED	SLAB/MATCHING
PAINT SILVER	E4	J	MDF	RECESSED	SLAB/MATCHING
PAINT STONE	LE	J	MDF	RECESSED	SLAB/MATCHING
PAINT VERDE	6L	J	MDF	RECESSED	SLAB/MATCHING
PAINT WHITE	PW	H	MDF	RECESSED	SLAB/MATCHING
PAINT WILLOW	OW	H	MDF	RECESSED	SLAB/MATCHING

Doors & Finishes: Carriage House Quick Reference

STYLE NAME	CODE	PRICE COLUMN	SPECIES	CENTER PANEL	DRAWER HEAD
MANCHESTER					
MAPLE AUBURN	SJ	E	MAPLE	RECESSED	FLAT
MAPLE ESPRESSO	SZ	E	MAPLE	RECESSED	FLAT
MAPLE SAND	SK	E	MAPLE	RECESSED	FLAT
MAPLE WALNUT	5T	E	MAPLE	RECESSED	FLAT
PAINT GRAY	SY	E	MDF	RECESSED	FLAT
PAINT SILVER	E5	F	MDF	RECESSED	FLAT
PAINT WHITE	SQ	E	MDF	RECESSED	FLAT
PAINT WILLOW	SX	E	MDF	RECESSED	FLAT
MILAN					
CHERRY AUBURN	WK	H	CHERRY	FLAT	FLAT
CHERRY WALNUT	WY	H	CHERRY	FLAT	FLAT
MAPLE AUBURN	IR	G	MAPLE	FLAT	FLAT
MAPLE ESPRESSO	IP	G	MAPLE	FLAT	FLAT
MAPLE PEWTER	WH	H	MAPLE	FLAT	FLAT
MAPLE SAND	IE	G	MAPLE	FLAT	FLAT
MAPLE WALNUT	5U	G	MAPLE	FLAT	FLAT
PAINT ARCTIC	IX	H	MDF	FLAT	FLAT
PAINT BLACK	JU	J	MDF	FLAT	FLAT
PAINT BLUE	PI	H	MDF	FLAT	FLAT
PAINT GRAY	ID	G	MDF	FLAT	FLAT
PAINT SILVER	E6	H	MDF	FLAT	FLAT
PAINT STONE	MY	H	MDF	FLAT	FLAT
PAINT VERDE	6N	H	MDF	FLAT	FLAT
PAINT WHITE	IW	G	MDF	FLAT	FLAT
PAINT WILLOW	IY	G	MDF	FLAT	FLAT
MONACO					
CHERRY AUBURN	FU	J	CHERRY	RECESSED	MATCHING
CHERRY WALNUT	FL	J	CHERRY	RECESSED	MATCHING
MAPLE AUBURN	TR	J	MAPLE	RECESSED	MATCHING
MAPLE ESPRESSO	FF	J	MAPLE	RECESSED	MATCHING
MAPLE PEWTER	FP	J	MAPLE	RECESSED	MATCHING
MAPLE SAND	FD	J	MAPLE	RECESSED	MATCHING
MAPLE WALNUT	5X	J	MAPLE	RECESSED	MATCHING
PAINT ARCTIC	CX	K	MDF	RECESSED	MATCHING
PAINT ARCTIC BLACK	GT	L	MDF	RECESSED	MATCHING
PAINT BLACK	GO	K	MDF	RECESSED	MATCHING
PAINT BLUE	KV	K	MDF	RECESSED	MATCHING
PAINT GRAY	GK	J	MDF	RECESSED	MATCHING
PAINT SILVER	E7	K	MDF	RECESSED	MATCHING
PAINT STONE	OS	K	MDF	RECESSED	MATCHING
PAINT VERDE	6O	K	MDF	RECESSED	MATCHING
PAINT WHITE	CO	J	MDF	RECESSED	MATCHING
PAINT WILLOW	GM	J	MDF	RECESSED	MATCHING



Doors & Finishes: Carriage House Quick Reference

STYLE NAME	CODE	PRICE COLUMN	SPECIES	CENTER PANEL	DRAWER HEAD
RITTENHOUSE					
CHERRY AUBURN	IF	J	CHERRY	RECESSED	MATCHING
CHERRY WALNUT	IK	J	CHERRY	RECESSED	MATCHING
MAPLE AUBURN	RK	J	MAPLE	RECESSED	MATCHING
MAPLE ESPRESSO	RN	J	MAPLE	RECESSED	MATCHING
MAPLE PEWTER	TW	J	MAPLE	RECESSED	MATCHING
MAPLE SAND	IQ	J	MAPLE	RECESSED	MATCHING
MAPLE WALNUT	5Y	J	MAPLE	RECESSED	MATCHING
PAINT ARCTIC	IZ	K	MDF	RECESSED	MATCHING
PAINT ARCTIC BLACK	TL	L	MDF	RECESSED	MATCHING
PAINT BLACK	TH	K	MDF	RECESSED	MATCHING
PAINT BLUE	NZ	K	MDF	RECESSED	MATCHING
PAINT GRAY	GR	J	MDF	RECESSED	MATCHING
PAINT SILVER	E8	K	MDF	RECESSED	MATCHING
PAINT STONE	TT	K	MDF	RECESSED	MATCHING
PAINT VERDE	6P	K	MDF	RECESSED	MATCHING
PAINT WHITE	RO	J	MDF	RECESSED	MATCHING
PAINT WILLOW	EJ	J	MDF	RECESSED	MATCHING
VENICE					
PAINT ARCTIC	B8	J	MDF	RECESSED	MATCHING
PAINT BLACK	B9	K	MDF	RECESSED	MATCHING
PAINT BLUE	BE	J	MDF	RECESSED	MATCHING
PAINT GRAY	BY	H	MDF	RECESSED	MATCHING
PAINT SILVER	D7	J	MDF	RECESSED	MATCHING
PAINT STONE	D4	J	MDF	RECESSED	MATCHING
PAINT VERDE	D6	H	MDF	RECESSED	MATCHING
PAINT WHITE	D5	H	MDF	RECESSED	MATCHING
PAINT WILLOW	D6	H	MDF	RECESSED	MATCHING
WENTWORTH					
CHERRY AUBURN	KA	K	CHERRY	SOLID RAISED	MATCHING
CHERRY WALNUT	WL	K	CHERRY	SOLID RAISED	MATCHING
MAPLE AUBURN	KF	J	MAPLE	SOLID RAISED	MATCHING
MAPLE ESPRESSO	KJ	J	MAPLE	SOLID RAISED	MATCHING
MAPLE PEWTER	KT	K	MAPLE	SOLID RAISED	MATCHING
MAPLE SAND	KL	J	MAPLE	SOLID RAISED	MATCHING
MAPLE WALNUT	5Z	J	MAPLE	SOLID RAISED	MATCHING
PAINT ARCTIC	KX	K	MDF	SOLID RAISED	MATCHING
PAINT ARCTIC BLACK	KS	L	MDF	SOLID RAISED	MATCHING
PAINT BLACK	KO	L	MDF	SOLID RAISED	MATCHING
PAINT BLUE	TZ	K	MDF	SOLID RAISED	MATCHING
PAINT GRAY	KR	J	MDF	SOLID RAISED	MATCHING
PAINT SILVER	E9	K	MDF	SOLID RAISED	MATCHING
PAINT STONE	WS	K	MDF	SOLID RAISED	MATCHING
PAINT VERDE	6R	K	MDF	SOLID RAISED	MATCHING
PAINT WHITE	WW	J	MDF	SOLID RAISED	MATCHING
PAINT WILLOW	WI	J	MDF	SOLID RAISED	MATCHING



Doors & Finishes: Carriage House Quick Reference

STYLE NAME	CODE	PRICE COLUMN	SPECIES	CENTER PANEL	DRAWER HEAD
YARDLEY					
CHERRY AUBURN	XA	K	CHERRY	SOLID RAISED	MATCHING
CHERRY WALNUT	YL	K	CHERRY	SOLID RAISED	MATCHING
MAPLE AUBURN	XF	J	MAPLE	SOLID RAISED	MATCHING
MAPLE ESPRESSO	XJ	J	MAPLE	SOLID RAISED	MATCHING
MAPLE PEWTER	YJ	K	MAPLE	SOLID RAISED	MATCHING
MAPLE SAND	XL	J	MAPLE	SOLID RAISED	MATCHING
MAPLE WALNUT	YV	J	MAPLE	SOLID RAISED	MATCHING
PAINT ARCTIC	YX	K	MDF	SOLID RAISED	MATCHING
PAINT ARCTIC BLACK	YS	L	MDF	SOLID RAISED	MATCHING
PAINT BLACK	XO	L	MDF	SOLID RAISED	MATCHING
PAINT BLUE	XU	K	MDF	SOLID RAISED	MATCHING
PAINT GRAY	XR	J	MDF	SOLID RAISED	MATCHING
PAINT SILVER	F4	K	MDF	SOLID RAISED	MATCHING
PAINT STONE	YT	K	MDF	SOLID RAISED	MATCHING
PAINT VERDE	YI	J	MDF	SOLID RAISED	MATCHING
PAINT WHITE	YW	J	MDF	SOLID RAISED	MATCHING
PAINT WILLOW	YI	J	MDF	SOLID RAISED	MATCHING

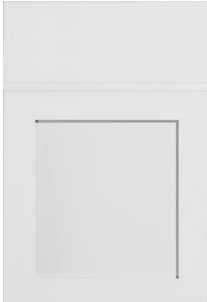

Doors & Finishes: Gatehouse Door Styles

BROOKFIELD	MAPLE / PAINT	AVAILABLE FINISHES									
 <p>7/16" Thick Veneer or MDF Raised Panel Solid Wood Frame (MDF Used For Paint) Modified Full Overlay Mortise and Tenon 6-Way Adj. Concealed Hinge One-Piece slab Drawer Head 5/8" reveal between drawer head and door</p> <p>Decorative Hardware is RECOMMENDED</p>	<table border="1" data-bbox="1045 243 1490 411"> <thead> <tr> <th>Maple</th> <th>Painted</th> </tr> </thead> <tbody> <tr> <td>• Auburn</td> <td>• Gray</td> </tr> <tr> <td>• Espresso</td> <td>• White</td> </tr> <tr> <td>• Sand</td> <td>• Willow</td> </tr> <tr> <td>• Walnut</td> <td></td> </tr> </tbody> </table>	Maple	Painted	• Auburn	• Gray	• Espresso	• White	• Sand	• Willow	• Walnut	
Maple	Painted										
• Auburn	• Gray										
• Espresso	• White										
• Sand	• Willow										
• Walnut											
CLEARBROOK	MAPLE / PAINT	AVAILABLE FINISHES									
 <p>1/4" Thick Veneer or MDF Recessed Panel Solid Wood Frame (MDF Used For Paint) Modified Full Overlay Mortise and Tenon 6-Way Adj. Concealed Hinge One-Piece slab Drawer Head 5/8" reveal between drawer head and door</p> <p>Decorative Hardware is RECOMMENDED</p>	<table border="1" data-bbox="1045 823 1490 991"> <thead> <tr> <th>Maple</th> <th>Painted</th> </tr> </thead> <tbody> <tr> <td>• Auburn</td> <td>• Gray</td> </tr> <tr> <td>• Espresso</td> <td>• White</td> </tr> <tr> <td>• Sand</td> <td>• Willow</td> </tr> <tr> <td>• Walnut</td> <td></td> </tr> </tbody> </table>	Maple	Painted	• Auburn	• Gray	• Espresso	• White	• Sand	• Willow	• Walnut	
Maple	Painted										
• Auburn	• Gray										
• Espresso	• White										
• Sand	• Willow										
• Walnut											
MISSION	MAPLE / PAINT	AVAILABLE FINISHES									
 <p>1/4" Thick Veneer or MDF Recessed Panel Solid Wood Frame (MDF Used For Paint) Shaker Style Modified Full Overlay Mortise and Tenon 6-Way Adj. Concealed Hinge One-Piece Flat Drawer Head 5/8" reveal between drawer head and door</p> <p>Decorative Hardware is RECOMMENDED</p>	<table border="1" data-bbox="1045 1402 1490 1570"> <thead> <tr> <th>Maple</th> <th>Painted</th> </tr> </thead> <tbody> <tr> <td>• Auburn</td> <td>• Gray</td> </tr> <tr> <td>• Espresso</td> <td>• White</td> </tr> <tr> <td>• Sand</td> <td>• Willow</td> </tr> <tr> <td>• Walnut</td> <td></td> </tr> </tbody> </table>	Maple	Painted	• Auburn	• Gray	• Espresso	• White	• Sand	• Willow	• Walnut	
Maple	Painted										
• Auburn	• Gray										
• Espresso	• White										
• Sand	• Willow										
• Walnut											



Doors & Finishes: Gatehouse Glass/Mullion Door Styles

FLAT GLASS	MAPLE / MDF	Available GHS Door Styles
 <p data-bbox="475 254 605 275">1/8" Flat Glass</p>	<p data-bbox="943 254 1390 275">Available on all Gatehouse (GHS) Door Styles</p>	
MULLION GLASS	MAPLE / MDF	Available GHS Door Styles
 <p data-bbox="475 835 605 856">1/8" Flat Glass</p>	<p data-bbox="943 846 1390 867">Available on all Gatehouse (GHS) Door Styles</p>	
Optional Reeded Glass (Glass Door)		Available GHS Door Styles
 <p data-bbox="475 1417 638 1438">Reeded Flat Glass</p>	<p data-bbox="943 1417 1406 1438">Available on all Gatehouse (GHS) Door Styles</p>	



Doors & Finishes: Carriage House Door Styles

ANNANDALE	CHERRY / MAPLE / PAINT	AVAILABLE FINISHES																																				
 <p>1/4" Thick Veneer or MDF Recessed Panel Solid Wood Frame (MDF Used For Paint) Modified Full Overlay Mitre Construction 6-Way Adj. Concealed Soft-Close Hinge One-Piece Raised Drawer Head 5/8" reveal between drawer head and door</p> <p>Decorative Hardware is RECOMMENDED</p>	<table border="1"> <thead> <tr> <th>Cherry</th> <th>Maple</th> <th>Painted</th> </tr> </thead> <tbody> <tr><td>• Auburn</td><td>• Auburn</td><td>• Arctic</td></tr> <tr><td>• Walnut</td><td>• Espresso</td><td>• Arctic Black</td></tr> <tr><td>• Walnut Black Dist.</td><td>• Pewter</td><td>• Black</td></tr> <tr><td></td><td>• Sand</td><td>• Black Dist.</td></tr> <tr><td></td><td>• Walnut</td><td>• Blue</td></tr> <tr><td></td><td></td><td>• Gray</td></tr> <tr><td></td><td></td><td>• Silver</td></tr> <tr><td></td><td></td><td>• Stone</td></tr> <tr><td></td><td></td><td>• Verde</td></tr> <tr><td></td><td></td><td>• White</td></tr> <tr><td></td><td></td><td>• Willow</td></tr> </tbody> </table>	Cherry	Maple	Painted	• Auburn	• Auburn	• Arctic	• Walnut	• Espresso	• Arctic Black	• Walnut Black Dist.	• Pewter	• Black		• Sand	• Black Dist.		• Walnut	• Blue			• Gray			• Silver			• Stone			• Verde			• White			• Willow	
Cherry	Maple	Painted																																				
• Auburn	• Auburn	• Arctic																																				
• Walnut	• Espresso	• Arctic Black																																				
• Walnut Black Dist.	• Pewter	• Black																																				
	• Sand	• Black Dist.																																				
	• Walnut	• Blue																																				
		• Gray																																				
		• Silver																																				
		• Stone																																				
		• Verde																																				
		• White																																				
		• Willow																																				
ARLINGTON	CHERRY / MAPLE / PAINT	AVAILABLE FINISHES																																				
 <p>3/4" Thick Solid Raised Panel Solid Wood Frame (MDF Used For Paint) Modified Full Overlay Mitre Construction 6-Way Adj. Concealed Soft-Close Hinge One-Piece Raised Drawer Head 5/8" reveal between drawer head and door</p> <p>Decorative Hardware is RECOMMENDED</p>	<table border="1"> <thead> <tr> <th>Cherry</th> <th>Maple</th> <th>Painted</th> </tr> </thead> <tbody> <tr><td>• Auburn</td><td>• Auburn</td><td>• Arctic</td></tr> <tr><td>• Walnut</td><td>• Espresso</td><td>• Arctic Black</td></tr> <tr><td>• Walnut Black Dist.</td><td>• Pewter</td><td>• Black</td></tr> <tr><td></td><td>• Sand</td><td>• Black Dist.</td></tr> <tr><td></td><td>• Walnut</td><td>• Blue</td></tr> <tr><td></td><td></td><td>• Gray</td></tr> <tr><td></td><td></td><td>• Silver</td></tr> <tr><td></td><td></td><td>• Stone</td></tr> <tr><td></td><td></td><td>• Verde</td></tr> <tr><td></td><td></td><td>• White</td></tr> <tr><td></td><td></td><td>• Willow</td></tr> </tbody> </table>	Cherry	Maple	Painted	• Auburn	• Auburn	• Arctic	• Walnut	• Espresso	• Arctic Black	• Walnut Black Dist.	• Pewter	• Black		• Sand	• Black Dist.		• Walnut	• Blue			• Gray			• Silver			• Stone			• Verde			• White			• Willow	
Cherry	Maple	Painted																																				
• Auburn	• Auburn	• Arctic																																				
• Walnut	• Espresso	• Arctic Black																																				
• Walnut Black Dist.	• Pewter	• Black																																				
	• Sand	• Black Dist.																																				
	• Walnut	• Blue																																				
		• Gray																																				
		• Silver																																				
		• Stone																																				
		• Verde																																				
		• White																																				
		• Willow																																				
AVALON	CHERRY / MAPLE / PAINT	AVAILABLE FINISHES																																				
 <p>1/4" Thick Veneer or MDF Recessed Panel Solid Wood Frame (MDF Used For Paint) Full Overlay Mortise/Tenon Construction 6-Way Adj. Concealed Soft-Close Hinge Five-Piece Drawer Head</p> <p>Decorative Hardware is REQUIRED</p>	<table border="1"> <thead> <tr> <th>Cherry</th> <th>Maple</th> <th>Painted</th> </tr> </thead> <tbody> <tr><td>• Auburn</td><td>• Auburn</td><td>• Arctic</td></tr> <tr><td>• Walnut</td><td>• Espresso</td><td>• Black</td></tr> <tr><td>• Walnut Black Dist.</td><td>• Pewter</td><td>• Blue</td></tr> <tr><td></td><td>• Sand</td><td>• Gray</td></tr> <tr><td></td><td>• Walnut</td><td>• Silver</td></tr> <tr><td></td><td></td><td>• Stone</td></tr> <tr><td></td><td></td><td>• White</td></tr> <tr><td></td><td></td><td>• Verde</td></tr> <tr><td></td><td></td><td>• Willow</td></tr> </tbody> </table>	Cherry	Maple	Painted	• Auburn	• Auburn	• Arctic	• Walnut	• Espresso	• Black	• Walnut Black Dist.	• Pewter	• Blue		• Sand	• Gray		• Walnut	• Silver			• Stone			• White			• Verde			• Willow							
Cherry	Maple	Painted																																				
• Auburn	• Auburn	• Arctic																																				
• Walnut	• Espresso	• Black																																				
• Walnut Black Dist.	• Pewter	• Blue																																				
	• Sand	• Gray																																				
	• Walnut	• Silver																																				
		• Stone																																				
		• White																																				
		• Verde																																				
		• Willow																																				



Doors & Finishes: Carriage House Door Styles

BERMUDA	PAINT	AVAILABLE FINISHES																																						
	<p>1/4" Thick Recessed MDF Beaded Panel MDF Frame Full Overlay Mortise and Tenon 6-Way Adj. Concealed Soft-Close Hinge One Piece Slab Drawer Head Matching Piece Drawer Fronts (9" and 11")</p> <p>Decorative Hardware is REQUIRED</p>	<table border="1"> <thead> <tr> <th colspan="3">Painted</th> </tr> </thead> <tbody> <tr><td>• Arctic</td><td></td><td></td></tr> <tr><td>• Arctic Black</td><td></td><td></td></tr> <tr><td>• Black</td><td></td><td></td></tr> <tr><td>• Blue</td><td></td><td></td></tr> <tr><td>• Gray</td><td></td><td></td></tr> <tr><td>• Silver</td><td></td><td></td></tr> <tr><td>• Stone</td><td></td><td></td></tr> <tr><td>• Verde</td><td></td><td></td></tr> <tr><td>• White</td><td></td><td></td></tr> <tr><td>• Willow</td><td></td><td></td></tr> </tbody> </table>			Painted			• Arctic			• Arctic Black			• Black			• Blue			• Gray			• Silver			• Stone			• Verde			• White			• Willow					
Painted																																								
• Arctic																																								
• Arctic Black																																								
• Black																																								
• Blue																																								
• Gray																																								
• Silver																																								
• Stone																																								
• Verde																																								
• White																																								
• Willow																																								
BRADFORD	MAPLE / PAINT	AVAILABLE FINISHES																																						
 <p><i>Value Series</i></p>	<p>7/16" Thick Veneer Raised Panel Solid Wood Frame (MDF Used For Paint) Modified Full Overlay Mortise and Tenon 6-Way Adj. Concealed Soft-Close Hinge One-Piece slab Drawer Head 5/8" reveal between drawer head and door Not available as custom doors or appliance panels</p> <p>Decorative Hardware is REQUIRED</p>	<table border="1"> <thead> <tr> <th>Maple</th> <th>Painted</th> </tr> </thead> <tbody> <tr><td>• Auburn</td><td>• Gray</td></tr> <tr><td>• Espresso</td><td>• Silver</td></tr> <tr><td>• Sand</td><td>• White</td></tr> <tr><td>• Walnut</td><td>• Willow</td></tr> </tbody> </table>			Maple	Painted	• Auburn	• Gray	• Espresso	• Silver	• Sand	• White	• Walnut	• Willow																										
Maple	Painted																																							
• Auburn	• Gray																																							
• Espresso	• Silver																																							
• Sand	• White																																							
• Walnut	• Willow																																							
CHARLESTOWN	CHERRY / MAPLE / PAINT	AVAILABLE FINISHES																																						
	<p>3/4" Thick Raised Panel Solid Wood Frame (MDF Used for Paint) Full Overlay Mitre Construction 6-Way Adj. Concealed Soft-Close Hinge Five-Piece Drawer Head</p> <p>Decorative Hardware is REQUIRED</p>	<table border="1"> <thead> <tr> <th>Cherry</th> <th>Maple</th> <th>Painted</th> </tr> </thead> <tbody> <tr><td>• Auburn</td><td>• Auburn</td><td>• Arctic</td></tr> <tr><td>• Walnut</td><td>• Espresso</td><td>• Arctic Black</td></tr> <tr><td>• Walnut Black Dist.</td><td>• Pewter</td><td>• Black</td></tr> <tr><td></td><td>• Sand</td><td>• Black Dist.</td></tr> <tr><td></td><td>• Walnut</td><td>• Blue</td></tr> <tr><td></td><td></td><td>• Gray</td></tr> <tr><td></td><td></td><td>• Silver</td></tr> <tr><td></td><td></td><td>• Stone</td></tr> <tr><td></td><td></td><td>• White</td></tr> <tr><td></td><td></td><td>• Verde</td></tr> <tr><td></td><td></td><td>• Willow</td></tr> </tbody> </table>			Cherry	Maple	Painted	• Auburn	• Auburn	• Arctic	• Walnut	• Espresso	• Arctic Black	• Walnut Black Dist.	• Pewter	• Black		• Sand	• Black Dist.		• Walnut	• Blue			• Gray			• Silver			• Stone			• White			• Verde			• Willow
Cherry	Maple	Painted																																						
• Auburn	• Auburn	• Arctic																																						
• Walnut	• Espresso	• Arctic Black																																						
• Walnut Black Dist.	• Pewter	• Black																																						
	• Sand	• Black Dist.																																						
	• Walnut	• Blue																																						
		• Gray																																						
		• Silver																																						
		• Stone																																						
		• White																																						
		• Verde																																						
		• Willow																																						

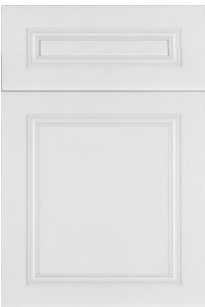

Doors & Finishes: Carriage House Door Styles

COVENTRY		MAPLE / PAINT	AVAILABLE FINISHES																																					
 <p>Value Series</p>	<p>1/4" Thick Veneer or MDF Recessed Panel Solid Wood Frame (MDF Used For Paint) Modified Full Overlay Mortise and Tenon 6-Way Adj. Concealed Soft-Close Hinge One-Piece slab Drawer Head 5/8" reveal between drawer head and door</p> <p>Decorative Hardware is REQUIRED</p>	<table border="1"> <thead> <tr> <th>Maple</th> <th>Painted</th> </tr> </thead> <tbody> <tr> <td>• Auburn</td> <td>• Gray</td> </tr> <tr> <td>• Espresso</td> <td>• Silver</td> </tr> <tr> <td>• Sand</td> <td>• White</td> </tr> <tr> <td>• Walnut</td> <td>• Willow</td> </tr> </tbody> </table>			Maple	Painted	• Auburn	• Gray	• Espresso	• Silver	• Sand	• White	• Walnut	• Willow																										
		Maple	Painted																																					
• Auburn	• Gray																																							
• Espresso	• Silver																																							
• Sand	• White																																							
• Walnut	• Willow																																							
<table border="1"> <thead> <tr> <th colspan="3">AVAILABLE FINISHES</th> </tr> <tr> <th colspan="3">Painted</th> </tr> </thead> <tbody> <tr><td>• Arctic</td></tr> <tr><td>• Arctic Black</td></tr> <tr><td>• Black</td></tr> <tr><td>• Blue</td></tr> <tr><td>• Gray</td></tr> <tr><td>• Silver</td></tr> <tr><td>• Stone</td></tr> <tr><td>• Verde</td></tr> <tr><td>• White</td></tr> <tr><td>• Willow</td></tr> </tbody> </table>		AVAILABLE FINISHES			Painted			• Arctic	• Arctic Black	• Black	• Blue	• Gray	• Silver	• Stone	• Verde	• White	• Willow																							
AVAILABLE FINISHES																																								
Painted																																								
• Arctic																																								
• Arctic Black																																								
• Black																																								
• Blue																																								
• Gray																																								
• Silver																																								
• Stone																																								
• Verde																																								
• White																																								
• Willow																																								
ELITE		PAINT	AVAILABLE FINISHES																																					
	<p>1/4" Thick Recessed MDF Panel MDF Frame Full Overlay Mitre Construction 6-Way Adj. Concealed Soft-Close Hinge One-Piece Raised Drawer Head 5/8" reveal between drawer head and door</p> <p>Decorative Hardware is RECOMMENDED</p>	<table border="1"> <thead> <tr> <th colspan="3">AVAILABLE FINISHES</th> </tr> <tr> <th colspan="3">Painted</th> </tr> </thead> <tbody> <tr><td>• Arctic</td></tr> <tr><td>• Arctic Black</td></tr> <tr><td>• Black</td></tr> <tr><td>• Blue</td></tr> <tr><td>• Gray</td></tr> <tr><td>• Silver</td></tr> <tr><td>• Stone</td></tr> <tr><td>• Verde</td></tr> <tr><td>• White</td></tr> <tr><td>• Willow</td></tr> </tbody> </table>			AVAILABLE FINISHES			Painted			• Arctic	• Arctic Black	• Black	• Blue	• Gray	• Silver	• Stone	• Verde	• White	• Willow																				
		AVAILABLE FINISHES																																						
Painted																																								
• Arctic																																								
• Arctic Black																																								
• Black																																								
• Blue																																								
• Gray																																								
• Silver																																								
• Stone																																								
• Verde																																								
• White																																								
• Willow																																								
<table border="1"> <thead> <tr> <th colspan="3">AVAILABLE FINISHES</th> </tr> <tr> <th>Cherry</th> <th>Maple</th> <th>Painted</th> </tr> </thead> <tbody> <tr> <td>• Auburn</td> <td>• Auburn</td> <td>• Arctic</td> </tr> <tr> <td>• Walnut</td> <td>• Espresso</td> <td>• Arctic Black</td> </tr> <tr> <td></td> <td>• Pewter</td> <td>• Black</td> </tr> <tr> <td></td> <td>• Sand</td> <td>• Black Dist.</td> </tr> <tr> <td></td> <td>• Walnut</td> <td>• Blue</td> </tr> <tr> <td></td> <td></td> <td>• Gray</td> </tr> <tr> <td></td> <td></td> <td>• Silver</td> </tr> <tr> <td></td> <td></td> <td>• Stone</td> </tr> <tr> <td></td> <td></td> <td>• Verde</td> </tr> <tr> <td></td> <td></td> <td>• White</td> </tr> <tr> <td></td> <td></td> <td>• Willow</td> </tr> </tbody> </table>		AVAILABLE FINISHES			Cherry	Maple	Painted	• Auburn	• Auburn	• Arctic	• Walnut	• Espresso	• Arctic Black		• Pewter	• Black		• Sand	• Black Dist.		• Walnut	• Blue			• Gray			• Silver			• Stone			• Verde			• White			• Willow
AVAILABLE FINISHES																																								
Cherry	Maple	Painted																																						
• Auburn	• Auburn	• Arctic																																						
• Walnut	• Espresso	• Arctic Black																																						
	• Pewter	• Black																																						
	• Sand	• Black Dist.																																						
	• Walnut	• Blue																																						
		• Gray																																						
		• Silver																																						
		• Stone																																						
		• Verde																																						
		• White																																						
		• Willow																																						
FOXWOOD		CHERRY / MAPLE / PAINT	AVAILABLE FINISHES																																					
	<p>1/4" Thick Recessed Panel Solid Wood Frame (MDF Used For Paint) Full Overlay Mitre Construction 6-Way Adj. Concealed Soft-Close Hinge Five-Piece Drawer Head</p> <p>Decorative Hardware is REQUIRED</p>	<table border="1"> <thead> <tr> <th>Cherry</th> <th>Maple</th> <th>Painted</th> </tr> </thead> <tbody> <tr> <td>• Auburn</td> <td>• Auburn</td> <td>• Arctic</td> </tr> <tr> <td>• Walnut</td> <td>• Espresso</td> <td>• Arctic Black</td> </tr> <tr> <td></td> <td>• Pewter</td> <td>• Black</td> </tr> <tr> <td></td> <td>• Sand</td> <td>• Black Dist.</td> </tr> <tr> <td></td> <td>• Walnut</td> <td>• Blue</td> </tr> <tr> <td></td> <td></td> <td>• Gray</td> </tr> <tr> <td></td> <td></td> <td>• Silver</td> </tr> <tr> <td></td> <td></td> <td>• Stone</td> </tr> <tr> <td></td> <td></td> <td>• Verde</td> </tr> <tr> <td></td> <td></td> <td>• White</td> </tr> <tr> <td></td> <td></td> <td>• Willow</td> </tr> </tbody> </table>			Cherry	Maple	Painted	• Auburn	• Auburn	• Arctic	• Walnut	• Espresso	• Arctic Black		• Pewter	• Black		• Sand	• Black Dist.		• Walnut	• Blue			• Gray			• Silver			• Stone			• Verde			• White			• Willow
		Cherry	Maple	Painted																																				
• Auburn	• Auburn	• Arctic																																						
• Walnut	• Espresso	• Arctic Black																																						
	• Pewter	• Black																																						
	• Sand	• Black Dist.																																						
	• Walnut	• Blue																																						
		• Gray																																						
		• Silver																																						
		• Stone																																						
		• Verde																																						
		• White																																						
		• Willow																																						



Doors & Finishes: Carriage House Door Styles

HAMPTON		PAINT		AVAILABLE FINISHES																																						
	<p>3/4" Thick Solid MDF Raised Panel</p> <p>MDF Frame</p> <p>Full Overlay</p> <p>Mitre Construction</p> <p>6-Way Adj. Concealed Soft-Close Hinge</p> <p>One-Piece Raised Drawer Head</p> <p>5/8" reveal between drawer head and door</p>				<table border="1"> <thead> <tr> <th colspan="2">Painted</th> </tr> </thead> <tbody> <tr><td>• Arctic</td></tr> <tr><td>• Arctic Black</td></tr> <tr><td>• Black</td></tr> <tr><td>• Blue</td></tr> <tr><td>• Gray</td></tr> <tr><td>• Silver</td></tr> <tr><td>• Stone</td></tr> <tr><td>• Verde</td></tr> <tr><td>• White</td></tr> <tr><td>• Willow</td></tr> </tbody> </table>		Painted		• Arctic	• Arctic Black	• Black	• Blue	• Gray	• Silver	• Stone	• Verde	• White	• Willow																								
		Painted																																								
• Arctic																																										
• Arctic Black																																										
• Black																																										
• Blue																																										
• Gray																																										
• Silver																																										
• Stone																																										
• Verde																																										
• White																																										
• Willow																																										
<p>Decorative Hardware is RECOMMENDED</p>																																										
JAMESTOWN		CHERRY / MAPLE / PAINT		AVAILABLE FINISHES																																						
	<p>1/4" Thick Veneer or MDF Recessed Panel</p> <p>Solid Wood Frame (MDF Used For Paint)</p> <p>Full Overlay</p> <p>Mitre Construction</p> <p>6-Way Adj. Concealed Soft-Close Hinge</p> <p>Five-Piece Drawer Head</p>				<table border="1"> <thead> <tr> <th>Cherry</th> <th>Maple</th> <th>Painted</th> </tr> </thead> <tbody> <tr><td>• Auburn</td><td>• Auburn</td><td>• Arctic</td></tr> <tr><td>• Walnut</td><td>• Espresso</td><td>• Arctic Black</td></tr> <tr><td>• Walnut Black Dist.</td><td>• Pewter</td><td>• Black</td></tr> <tr><td></td><td>• Sand</td><td>• Black Dist.</td></tr> <tr><td></td><td>• Walnut</td><td>• Blue</td></tr> <tr><td></td><td></td><td>• Gray</td></tr> <tr><td></td><td></td><td>• Silver</td></tr> <tr><td></td><td></td><td>• Stone</td></tr> <tr><td></td><td></td><td>• Verde</td></tr> <tr><td></td><td></td><td>• White</td></tr> <tr><td></td><td></td><td>• Willow</td></tr> </tbody> </table>		Cherry	Maple	Painted	• Auburn	• Auburn	• Arctic	• Walnut	• Espresso	• Arctic Black	• Walnut Black Dist.	• Pewter	• Black		• Sand	• Black Dist.		• Walnut	• Blue			• Gray			• Silver			• Stone			• Verde			• White			• Willow
		Cherry	Maple	Painted																																						
• Auburn	• Auburn	• Arctic																																								
• Walnut	• Espresso	• Arctic Black																																								
• Walnut Black Dist.	• Pewter	• Black																																								
	• Sand	• Black Dist.																																								
	• Walnut	• Blue																																								
		• Gray																																								
		• Silver																																								
		• Stone																																								
		• Verde																																								
		• White																																								
		• Willow																																								
<p>Decorative Hardware is REQUIRED</p>																																										
LANCASTER		CHERRY / MAPLE / PAINT		AVAILABLE FINISHES																																						
	<p>1/4" Thick Veneer or MDF Recessed Panel</p> <p>Solid Wood Frame (MDF Used For Paint)</p> <p>Full Overlay</p> <p>Mortise and Tenon</p> <p>6-Way Adj. Concealed Soft-Close Hinge</p> <p>Five-Piece Drawer Head</p>				<table border="1"> <thead> <tr> <th>Cherry</th> <th>Maple</th> <th>Painted</th> </tr> </thead> <tbody> <tr><td>• Auburn</td><td>• Auburn</td><td>• Arctic</td></tr> <tr><td>• Walnut</td><td>• Espresso</td><td>• Arctic Black</td></tr> <tr><td></td><td>• Pewter</td><td>• Black</td></tr> <tr><td></td><td>• Sand</td><td>• Blue</td></tr> <tr><td></td><td>• Walnut</td><td>• Gray</td></tr> <tr><td></td><td></td><td>• Silver</td></tr> <tr><td></td><td></td><td>• Stone</td></tr> <tr><td></td><td></td><td>• Verde</td></tr> <tr><td></td><td></td><td>• White</td></tr> <tr><td></td><td></td><td>• Willow</td></tr> </tbody> </table>		Cherry	Maple	Painted	• Auburn	• Auburn	• Arctic	• Walnut	• Espresso	• Arctic Black		• Pewter	• Black		• Sand	• Blue		• Walnut	• Gray			• Silver			• Stone			• Verde			• White			• Willow			
		Cherry	Maple	Painted																																						
• Auburn	• Auburn	• Arctic																																								
• Walnut	• Espresso	• Arctic Black																																								
	• Pewter	• Black																																								
	• Sand	• Blue																																								
	• Walnut	• Gray																																								
		• Silver																																								
		• Stone																																								
		• Verde																																								
		• White																																								
		• Willow																																								
<p>Decorative Hardware is REQUIRED</p>																																										

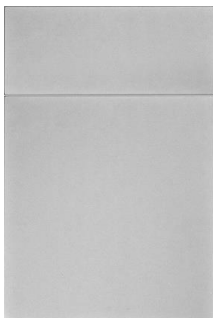
Doors & Finishes: Carriage House Door Styles

MALIBU	CHERRY / MAPLE / PAINT	AVAILABLE FINISHES																														
 <p>1/4" Thick Veneer or MDF Recessed Panel Solid Wood Frame (MDF Used For Paint) Full Overlay Mortise and Tenon in Painted Mitre Construction in Cherry and Maple 6-Way Adj. Concealed Soft-Close Hinge One-Piece Slab Drawer Head Matching Drawer Fronts (9" and 11") Decorative Hardware is REQUIRED</p>	<table border="1"> <thead> <tr> <th>Cherry</th> <th>Maple</th> <th>Painted</th> </tr> </thead> <tbody> <tr> <td>• Auburn</td> <td>• Auburn</td> <td>• Arctic</td> </tr> <tr> <td>• Walnut</td> <td>• Espresso</td> <td>• Black</td> </tr> <tr> <td></td> <td>• Pewter</td> <td>• Blue</td> </tr> <tr> <td></td> <td>• Sand</td> <td>• Gray</td> </tr> <tr> <td></td> <td>• Walnut</td> <td>• Silver</td> </tr> <tr> <td></td> <td></td> <td>• Stone</td> </tr> <tr> <td></td> <td></td> <td>• White</td> </tr> <tr> <td></td> <td></td> <td>• Verde</td> </tr> <tr> <td></td> <td></td> <td>• Willow</td> </tr> </tbody> </table>		Cherry	Maple	Painted	• Auburn	• Auburn	• Arctic	• Walnut	• Espresso	• Black		• Pewter	• Blue		• Sand	• Gray		• Walnut	• Silver			• Stone			• White			• Verde			• Willow
	Cherry	Maple	Painted																													
• Auburn	• Auburn	• Arctic																														
• Walnut	• Espresso	• Black																														
	• Pewter	• Blue																														
	• Sand	• Gray																														
	• Walnut	• Silver																														
		• Stone																														
		• White																														
		• Verde																														
		• Willow																														
<table border="1"> <thead> <tr> <th>Maple</th> <th>Painted</th> </tr> </thead> <tbody> <tr> <td>• Auburn</td> <td>• Gray</td> </tr> <tr> <td>• Espresso</td> <td>• Silver</td> </tr> <tr> <td>• Sand</td> <td>• White</td> </tr> <tr> <td>• Walnut</td> <td>• Willow</td> </tr> </tbody> </table>		Maple	Painted	• Auburn	• Gray	• Espresso	• Silver	• Sand	• White	• Walnut	• Willow																					
Maple	Painted																															
• Auburn	• Gray																															
• Espresso	• Silver																															
• Sand	• White																															
• Walnut	• Willow																															
MANCHESTER	MAPLE / PAINT	AVAILABLE FINISHES																														
 <p>1/4" Thick Veneer or MDF Recessed Panel Solid Wood Frame (MDF Used For Paint) Shaker Style Full Overlay Mortise and Tenon 6-Way Adj. Soft-Close Concealed Hinge One-Piece slab Drawer Head 5/8" reveal between drawer head and door Decorative Hardware is REQUIRED</p> <p><i>Value Series</i></p>	<table border="1"> <thead> <tr> <th>Maple</th> <th>Painted</th> </tr> </thead> <tbody> <tr> <td>• Auburn</td> <td>• Gray</td> </tr> <tr> <td>• Espresso</td> <td>• Silver</td> </tr> <tr> <td>• Sand</td> <td>• White</td> </tr> <tr> <td>• Walnut</td> <td>• Willow</td> </tr> </tbody> </table>		Maple	Painted	• Auburn	• Gray	• Espresso	• Silver	• Sand	• White	• Walnut	• Willow																				
	Maple	Painted																														
• Auburn	• Gray																															
• Espresso	• Silver																															
• Sand	• White																															
• Walnut	• Willow																															
<table border="1"> <thead> <tr> <th>Cherry</th> <th>Maple</th> <th>Painted</th> </tr> </thead> <tbody> <tr> <td>• Auburn</td> <td>• Auburn</td> <td>• Arctic</td> </tr> <tr> <td>• Walnut</td> <td>• Espresso</td> <td>• Black</td> </tr> <tr> <td></td> <td>• Pewter</td> <td>• Blue</td> </tr> <tr> <td></td> <td>• Sand</td> <td>• Gray</td> </tr> <tr> <td></td> <td>• Walnut</td> <td>• Silver</td> </tr> <tr> <td></td> <td></td> <td>• Stone</td> </tr> <tr> <td></td> <td></td> <td>• White</td> </tr> <tr> <td></td> <td></td> <td>• Verde</td> </tr> <tr> <td></td> <td></td> <td>• Willow</td> </tr> </tbody> </table>		Cherry	Maple	Painted	• Auburn	• Auburn	• Arctic	• Walnut	• Espresso	• Black		• Pewter	• Blue		• Sand	• Gray		• Walnut	• Silver			• Stone			• White			• Verde			• Willow	
Cherry	Maple	Painted																														
• Auburn	• Auburn	• Arctic																														
• Walnut	• Espresso	• Black																														
	• Pewter	• Blue																														
	• Sand	• Gray																														
	• Walnut	• Silver																														
		• Stone																														
		• White																														
		• Verde																														
		• Willow																														
MILAN	CHERRY / MAPLE / PAINT	AVAILABLE FINISHES																														
 <p>3/4" Thick Flush Veneer Panel or MDF Panel Full Overlay 6-Way Adj. Soft-Close Concealed Hinge One-Piece Drawer Head Decorative Hardware is REQUIRED</p>	<table border="1"> <thead> <tr> <th>Cherry</th> <th>Maple</th> <th>Painted</th> </tr> </thead> <tbody> <tr> <td>• Auburn</td> <td>• Auburn</td> <td>• Arctic</td> </tr> <tr> <td>• Walnut</td> <td>• Espresso</td> <td>• Black</td> </tr> <tr> <td></td> <td>• Pewter</td> <td>• Blue</td> </tr> <tr> <td></td> <td>• Sand</td> <td>• Gray</td> </tr> <tr> <td></td> <td>• Walnut</td> <td>• Silver</td> </tr> <tr> <td></td> <td></td> <td>• Stone</td> </tr> <tr> <td></td> <td></td> <td>• White</td> </tr> <tr> <td></td> <td></td> <td>• Verde</td> </tr> <tr> <td></td> <td></td> <td>• Willow</td> </tr> </tbody> </table>		Cherry	Maple	Painted	• Auburn	• Auburn	• Arctic	• Walnut	• Espresso	• Black		• Pewter	• Blue		• Sand	• Gray		• Walnut	• Silver			• Stone			• White			• Verde			• Willow
	Cherry	Maple	Painted																													
• Auburn	• Auburn	• Arctic																														
• Walnut	• Espresso	• Black																														
	• Pewter	• Blue																														
	• Sand	• Gray																														
	• Walnut	• Silver																														
		• Stone																														
		• White																														
		• Verde																														
		• Willow																														
<table border="1"> <thead> <tr> <th>Maple</th> <th>Painted</th> </tr> </thead> <tbody> <tr> <td>• Auburn</td> <td>• Gray</td> </tr> <tr> <td>• Espresso</td> <td>• Silver</td> </tr> <tr> <td>• Sand</td> <td>• White</td> </tr> <tr> <td>• Walnut</td> <td>• Willow</td> </tr> </tbody> </table>		Maple	Painted	• Auburn	• Gray	• Espresso	• Silver	• Sand	• White	• Walnut	• Willow																					
Maple	Painted																															
• Auburn	• Gray																															
• Espresso	• Silver																															
• Sand	• White																															
• Walnut	• Willow																															

Doors & Finishes: Carriage House Door Styles



MONACO		CHERRY / MAPLE / PAINT	AVAILABLE FINISHES																																					
	<p>1/4" Thick Veneer or MDF Recessed Panel Solid Wood Frame (MDF Used For Paint) Full Overlay Mitre Construction 6-Way Adj. Soft-Close Concealed Hinge Matching Drawer Head</p> <p>Decorative Hardware is REQUIRED</p>	<table border="1"> <thead> <tr> <th>Cherry</th> <th>Maple</th> <th>Painted</th> </tr> </thead> <tbody> <tr> <td>• Auburn</td> <td>• Auburn</td> <td>• Arctic</td> </tr> <tr> <td>• Walnut</td> <td>• Espresso</td> <td>• Arctic Black</td> </tr> <tr> <td></td> <td>• Pewter</td> <td>• Black</td> </tr> <tr> <td></td> <td>• Sand</td> <td>• Blue</td> </tr> <tr> <td></td> <td>• Walnut</td> <td>• Gray</td> </tr> <tr> <td></td> <td></td> <td>• Silver</td> </tr> <tr> <td></td> <td></td> <td>• Stone</td> </tr> <tr> <td></td> <td></td> <td>• White</td> </tr> <tr> <td></td> <td></td> <td>• Verde</td> </tr> <tr> <td></td> <td></td> <td>• Willow</td> </tr> </tbody> </table>			Cherry	Maple	Painted	• Auburn	• Auburn	• Arctic	• Walnut	• Espresso	• Arctic Black		• Pewter	• Black		• Sand	• Blue		• Walnut	• Gray			• Silver			• Stone			• White			• Verde			• Willow			
		Cherry	Maple	Painted																																				
		• Auburn	• Auburn	• Arctic																																				
		• Walnut	• Espresso	• Arctic Black																																				
			• Pewter	• Black																																				
			• Sand	• Blue																																				
			• Walnut	• Gray																																				
				• Silver																																				
				• Stone																																				
				• White																																				
		• Verde																																						
		• Willow																																						
<h3>RITTENHOUSE</h3>		CHERRY / MAPLE / PAINT	AVAILABLE FINISHES																																					
	<p>1/4" Thick Veneer or MDF Recessed Panel Solid Wood Frame (MDF Used For Paint) Full Overlay Mitre Construction 6-Way Adj. Concealed Soft-Close Hinge Matching Drawer Head</p> <p>Decorative Hardware is REQUIRED</p>	<table border="1"> <thead> <tr> <th>Cherry</th> <th>Maple</th> <th>Painted</th> </tr> </thead> <tbody> <tr> <td>• Auburn</td> <td>• Auburn</td> <td>• Arctic</td> </tr> <tr> <td>• Walnut</td> <td>• Espresso</td> <td>• Arctic Black</td> </tr> <tr> <td></td> <td>• Pewter</td> <td>• Black</td> </tr> <tr> <td></td> <td>• Sand</td> <td>• Blue</td> </tr> <tr> <td></td> <td>• Walnut</td> <td>• Gray</td> </tr> <tr> <td></td> <td></td> <td>• Silver</td> </tr> <tr> <td></td> <td></td> <td>• Stone</td> </tr> <tr> <td></td> <td></td> <td>• White</td> </tr> <tr> <td></td> <td></td> <td>• Verde</td> </tr> <tr> <td></td> <td></td> <td>• Willow</td> </tr> </tbody> </table>			Cherry	Maple	Painted	• Auburn	• Auburn	• Arctic	• Walnut	• Espresso	• Arctic Black		• Pewter	• Black		• Sand	• Blue		• Walnut	• Gray			• Silver			• Stone			• White			• Verde			• Willow			
		Cherry	Maple	Painted																																				
		• Auburn	• Auburn	• Arctic																																				
		• Walnut	• Espresso	• Arctic Black																																				
			• Pewter	• Black																																				
			• Sand	• Blue																																				
			• Walnut	• Gray																																				
				• Silver																																				
				• Stone																																				
				• White																																				
		• Verde																																						
		• Willow																																						
<h3>VENICE</h3>		PAINT	AVAILABLE FINISHES																																					
	<p>5/8" Thick MDF Recessed Panel Solid MDF Frame Full Overlay Mite Construction 6-Way Adj. Concealed Soft Close Hinge Matching Drawer Head</p> <p>Decorative Hardware is REQUIRED</p>	<table border="1"> <thead> <tr> <th>Painted</th> </tr> </thead> <tbody> <tr> <td>• Arctic</td> </tr> <tr> <td>• Black</td> </tr> <tr> <td>• Blue</td> </tr> <tr> <td>• Gray</td> </tr> <tr> <td>• Silver</td> </tr> <tr> <td>• Stone</td> </tr> <tr> <td>• White</td> </tr> <tr> <td>• Verde</td> </tr> <tr> <td>• Willow</td> </tr> </tbody> </table>			Painted	• Arctic	• Black	• Blue	• Gray	• Silver	• Stone	• White	• Verde	• Willow																										
		Painted																																						
		• Arctic																																						
		• Black																																						
		• Blue																																						
		• Gray																																						
		• Silver																																						
		• Stone																																						
		• White																																						
		• Verde																																						
• Willow																																								

Doors & Finishes: Carriage House Door Styles

WENTWORTH	CHERRY / MAPLE / PAINT	AVAILABLE FINISHES																																	
 <p>3/4" Thick Solid Raised Panel Solid Wood Frame (MDF Used For Paint) Full Overlay Mitre Construction 6-Way Adj. Concealed Soft-Close Hinge Five-Piece Drawer Head</p> <p>Decorative Hardware is REQUIRED</p>		<table border="1" style="width: 100%; border-collapse: collapse;"> <thead> <tr style="background-color: #cccccc;"> <th>Cherry</th> <th>Maple</th> <th>Painted</th> </tr> </thead> <tbody> <tr><td>• Auburn</td><td>• Auburn</td><td>• Arctic</td></tr> <tr><td>• Walnut</td><td>• Espresso</td><td>• Arctic Black</td></tr> <tr><td></td><td>• Pewter</td><td>• Black</td></tr> <tr><td></td><td>• Sand</td><td>• Blue</td></tr> <tr><td></td><td>• Walnut</td><td>• Gray</td></tr> <tr><td></td><td></td><td>• Silver</td></tr> <tr><td></td><td></td><td>• Stone</td></tr> <tr><td></td><td></td><td>• White</td></tr> <tr><td></td><td></td><td>• Verde</td></tr> <tr><td></td><td></td><td>• Willow</td></tr> </tbody> </table>	Cherry	Maple	Painted	• Auburn	• Auburn	• Arctic	• Walnut	• Espresso	• Arctic Black		• Pewter	• Black		• Sand	• Blue		• Walnut	• Gray			• Silver			• Stone			• White			• Verde			• Willow
Cherry	Maple	Painted																																	
• Auburn	• Auburn	• Arctic																																	
• Walnut	• Espresso	• Arctic Black																																	
	• Pewter	• Black																																	
	• Sand	• Blue																																	
	• Walnut	• Gray																																	
		• Silver																																	
		• Stone																																	
		• White																																	
		• Verde																																	
		• Willow																																	

YARDLEY	CHERRY / MAPLE / PAINT	AVAILABLE FINISHES																																	
 <p>3/4" Thick Solid Raised Panel Solid Wood Frame (MDF Used For Paint) Full Overlay Mortise and Tenon 6-Way Adj. Concealed Soft-Close Hinge Five-Piece Drawer Head</p> <p>Decorative Hardware is REQUIRED</p>		<table border="1" style="width: 100%; border-collapse: collapse;"> <thead> <tr style="background-color: #cccccc;"> <th>Cherry</th> <th>Maple</th> <th>Painted</th> </tr> </thead> <tbody> <tr><td>• Auburn</td><td>• Auburn</td><td>• Arctic</td></tr> <tr><td>• Walnut</td><td>• Espresso</td><td>• Arctic Black</td></tr> <tr><td></td><td>• Pewter</td><td>• Black</td></tr> <tr><td></td><td>• Sand</td><td>• Blue</td></tr> <tr><td></td><td>• Walnut</td><td>• Gray</td></tr> <tr><td></td><td></td><td>• Silver</td></tr> <tr><td></td><td></td><td>• Stone</td></tr> <tr><td></td><td></td><td>• White</td></tr> <tr><td></td><td></td><td>• Verde</td></tr> <tr><td></td><td></td><td>• Willow</td></tr> </tbody> </table>	Cherry	Maple	Painted	• Auburn	• Auburn	• Arctic	• Walnut	• Espresso	• Arctic Black		• Pewter	• Black		• Sand	• Blue		• Walnut	• Gray			• Silver			• Stone			• White			• Verde			• Willow
Cherry	Maple	Painted																																	
• Auburn	• Auburn	• Arctic																																	
• Walnut	• Espresso	• Arctic Black																																	
	• Pewter	• Black																																	
	• Sand	• Blue																																	
	• Walnut	• Gray																																	
		• Silver																																	
		• Stone																																	
		• White																																	
		• Verde																																	
		• Willow																																	

Doors & Finishes: Carriage House Glass/Mullion Door Styles

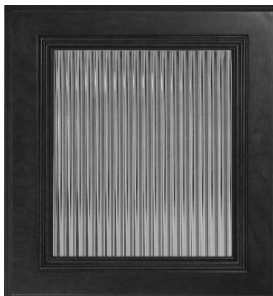
FLAT GLASS	CHERRY / MAPLE / MDF	Available CHS Door Styles
	<p>1/8" Flat Glass</p>	<p>Available on all Carriage House (CHS) Door Styles</p> <p>**Standard Offering for Milan and Monaco Door Styles**</p> <p>Venice door style manufactured without perimeter molding.</p>
MULLION GLASS	CHERRY / MAPLE / MDF	Available CHS Door Styles
	<p>1/8" Flat Glass</p>	<p>Available on all Carriage House (CHS) Door Styles, EXCEPT:</p> <ul style="list-style-type: none"> • Milan • Monaco • Venice
Optional Reeded Glass (Shown with Glass Door)		Available CHS Door Styles
 <p><i>Reeded Glass Door Available as an Upgrade</i></p>	<p>1/8" Reeded Flat Glass</p>	<p>Available on all Carriage House (CHS) Door Styles</p>

TAB: Wall Cabinetry

- *Index*
- *Construction Options & Modifications Key*
- *Cabinet Selection*
- *Frame with Doors*

Wall Cabinetry

Page Location	Cabinet Type	Nomenclature
55	Alumasteel Panel	ALMSTL
44	Construction Options & Modifications Key	
53	Cubbies	CUB
49	Counter Depth Coffee Maker	COFC
56	Door Face Frame	DRFF
55	Range Hood	RH
54	Range Hood Tapered	RHT
45-48	Wall	W
50	Wall Blind Corner	WBC
49	Wall Corner	WC
49-50	Wall Corner Lazy Susan	WCLS
51-53	Wall Drawer	WD
51	Wall End Corner	WEC
49	Wall Microwave Cabinet	MW
51	Wall Pie Cut Corner	WPC
48	Wine Rack Lattice	WRL
48	Wine Rack Diagonal	WRD
48	Wine Stem Rack	WSR
53	Wall Lift-Up	WLIFT
54	Wall Range Hood	WRH

Wall Cabinets

Finished Side Codes	
Description	Veneer Code
12" High - Wall	WV12
15" High - Wall	WV15
18" High - Wall	WV18
24" High - Wall	WV24
30" High - Wall	WV30
36" High - Wall	WV36
42" High - Wall	WV42
48" High - Wall	WV48
54" High - Wall	WV54
60" High - Wall	WV60

Cabinet Box Modification Codes	
BOX	Box with no doors or drawer heads
364	Box Only (No drawers/pullouts/doors/drawerheads/shelves/hinges)
BOB	Box Only (No drawers/pullouts/doors/drawerheads/shelves/hinges) With Beaded Back
PLY	Plywood Sides
AWB	All Wood Box
TKA	Toekick Add-On

Door / Drawer Front Modification Codes	
SCH	Soft Close Door Hinges **This option is offered for Gatehouse Series Only

Wall Cabinetry

Wall Cabinets

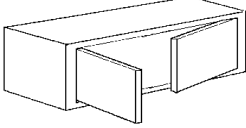
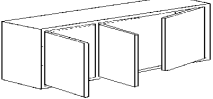
	Width	Height	Depth	Cabinet Doors	Frame Construction	
Wall - Height: 12" (Double Door)						
	W2412	24	12	12	◆ (2) DR1212	No Shelf
	W3012	30	12	12	◆ (2) DR1512	
	W3312	33	12	12	◆ (2) DR1612	
	W3612	36	12	12	◆ (2) DR1812	
	W3912	39	12	12	◆ (2) DR1912	
	W4212	42	12	12	◆ (2) DR2112	
	W4812 L/R	48	12	12	◆ (1) DR1512 (2) DR1612	No Shelf L/R designates hinging of single door

Shown as left

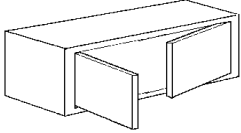
	Width	Height	Depth	Cabinet Doors	Frame Construction	
Wall - Height: 15" (Double Door)						
	W3015	30	15	12	◆ (2) DR1515	No Shelf
	W3315	33	15	12	◆ (2) DR1615	
	W3615	36	15	12	◆ (2) DR1815	
	W3915	39	15	12	◆ (2) DR1915	

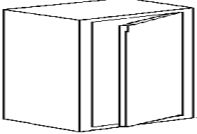
	Width	Height	Depth	Cabinet Doors	Frame Construction	
Wall - Height: 18"						
	W0918 L/R	9	18	12	◆ (1) DR0918	No Shelf
	W1218 L/R	12	18	12	◆ (1) DR1218	
	W1518 L/R	15	18	12	◆ (1) DR1518	
	W1818 L/R	18	18	12	◆ (1) DR1818	
	W2118 L/R	21	18	12	◆ (1) DR2118	

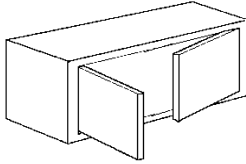
	W2418	24	18	12	◆ (2) DR1218	No Shelf
	W2718	27	18	12	◆ (2) DR1318	
	W3018	30	18	12	◆ (2) DR1518	
	W3318	33	18	12	◆ (2) DR1618	
	W3618	36	18	12	◆ (2) DR1818	
	W3918	39	18	12	◆ (2) DR1918	
	W4218	39	18	12	◆ (2) DR2118	

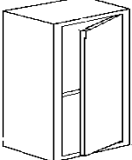
	Width	Height	Depth	Cabinet Doors	Frame Construction	
Wall - Height: 24"						
	W1524 L/R	15	23 ^{5/8}	12	◆ (1) DR1524	1 Adjustable Shelf
	W1824 L/R	18	23 ^{5/8}	12	◆ (1) DR1824	
	W2124 L/R	21	23 ^{5/8}	12	◆ (1) DR2124	

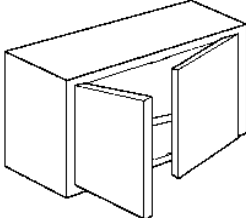
	W2424	24	23 ^{5/8}	12	◆ (2) DR1224	1 Adjustable Shelf
	W2724	27	23 ^{5/8}	12	◆ (2) DR1324	
	W3024	30	23 ^{5/8}	12	◆ (2) DR1524	
	W3324	33	23 ^{5/8}	12	◆ (2) DR1624	
	W3624	36	23 ^{5/8}	12	◆ (2) DR1824	
	W3924	39	23 ^{5/8}	12	◆ (2) DR1924	
	W4224	42	23 ^{5/8}	12	◆ (2) DR2124	

Wall Cabinetry

Wall Cabinets

Width Height Depth Cabinet Doors

Wall - Height: 30"

Frame Construction

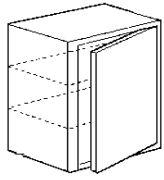

W0930 L/R	9	30 ^{9/16}	12	◆ (1) DR0930	2 Adjustable Shelves
W1230 L/R	12	30 ^{9/16}	12	◆ (1) DR1230	
W1530 L/R	15	30 ^{9/16}	12	◆ (1) DR1530	
W1830 L/R	18	30 ^{9/16}	12	◆ (1) DR1830	
W2130 L/R	21	30 ^{9/16}	12	◆ (1) DR2130	

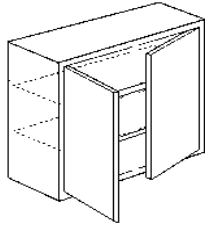

W2430	24	30 ^{9/16}	12	◆ (2) DR1230	2 Adjustable Shelves
W2730	27	30 ^{9/16}	12	◆ (2) DR1330	
W3030	30	30 ^{9/16}	12	◆ (2) DR1530	
W3330	33	30 ^{9/16}	12	◆ (2) DR1630	
W3630	36	30 ^{9/16}	12	◆ (2) DR1830	
W3930	39	30 ^{9/16}	12	◆ (2) DR1930	
W4230	42	30 ^{9/16}	12	◆ (2) DR2130	

Wall - Height: 36"

Frame Construction

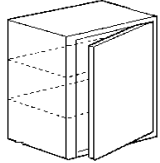

W0936 L/R	9	36	12	◆ (1) DR0936	2 Adjustable Shelves
W1236 L/R	12	36	12	◆ (1) DR1236	
W1536 L/R	15	36	12	◆ (1) DR1536	
W1836 L/R	18	36	12	◆ (1) DR1836	
W2136 L/R	21	36	12	◆ (1) DR2136	

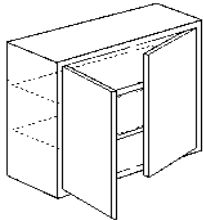

W2436	24	36	12	◆ (2) DR1236	2 Adjustable Shelves
W2736	27	36	12	◆ (2) DR1336	
W3036	30	36	12	◆ (2) DR1536	
W3336	33	36	12	◆ (2) DR1636	
W3636	36	36	12	◆ (2) DR1836	
W3936	39	36	12	◆ (2) DR1936	
W4236	42	36	12	◆ (2) DR2136	

Wall - Height: 42"

Frame Construction

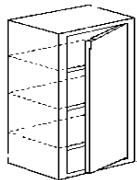

W0942 L/R	9	41 ^{7/8}	12	◆ (1) DR0942	3 Adjustable Shelves
W1242 L/R	12	41 ^{7/8}	12	◆ (1) DR1242	
W1542 L/R	15	41 ^{7/8}	12	◆ (1) DR1542	
W1842 L/R	18	41 ^{7/8}	12	◆ (1) DR1842	
W2142 L/R	21	41 ^{7/8}	12	◆ (1) DR2142	

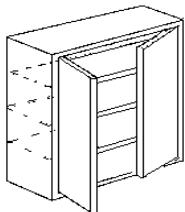

W2442	24	41 ^{7/8}	12	◆ (2) DR1242	3 Adjustable Shelves
W2742	27	41 ^{7/8}	12	◆ (2) DR1342	
W3042	30	41 ^{7/8}	12	◆ (2) DR1542	
W3342	33	41 ^{7/8}	12	◆ (2) DR1642	
W3642	36	41 ^{7/8}	12	◆ (2) DR1842	
W3942	39	41 ^{7/8}	12	◆ (2) DR1942	
W4242	42	41 ^{7/8}	12	◆ (2) DR2142	

Wall Cabinetry

Wall Cabinets

Wall - Height: 48" Available in Carriage House Series Only **Frame Construction**

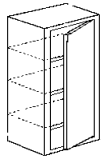

Model	Width	Height	Depth	Cabinet Doors
W1248 L/R	12	48	12	◆ (1) DR1248
W1548 L/R	15	48	12	◆ (1) DR1548
W1848 L/R	18	48	12	◆ (1) DR1848
W2148 L/R	21	48	12	◆ (1) DR2148

3 Adjustable Shelves

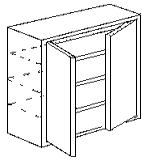

W2448	24	48	12	◆ (2) DR1248
W2748	27	48	12	◆ (2) DR1348
W3048	30	48	12	◆ (2) DR1548
W3348	33	48	12	◆ (2) DR1648
W3648	36	48	12	◆ (2) DR1848

3 Adjustable Shelves

Wall - Depth: 09" (Single Door) Available in Carriage House Series Only **Frame Construction**

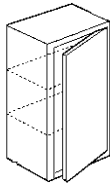

W153009 L/R	15	30 ^{9/16}	9	◆ (1) DR1530
W183009 L/R	18	30 ^{9/16}	9	◆ (1) DR1830
W153609 L/R	15	36	9	◆ (1) DR1536
W183609 L/R	18	36	9	◆ (1) DR1836
W154209 L/R	15	41 ^{7/8}	9	◆ (1) DR1542
W184209 L/R	18	41 ^{7/8}	9	◆ (1) DR1842

2 Shelves (ADJUSTABLE)

3 Shelves (ADJUSTABLE)

Wall - Depth: 09" (Double Door) Available in Carriage House Series Only **Frame Construction**

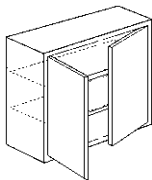

W303009	30	30 ^{9/16}	9	◆ (2) DR1530
W363009	36	30 ^{9/16}	9	◆ (2) DR1830
W303609	30	36	9	◆ (2) DR1536
W363609	36	36	9	◆ (2) DR1836
W304209	30	41 ^{7/8}	9	◆ (2) DR1542
W364209	36	41 ^{7/8}	9	◆ (2) DR1842

2 Shelves (ADJUSTABLE)

3 Shelves (Adjustable)

Wall - Depth: 15" (Single Door) Available in Carriage House Series Only **Frame Construction**

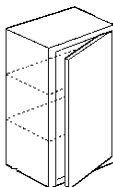

W153015 L/R	15	30 ^{9/16}	15	◆ (1) DR1530
W183015 L/R	18	30 ^{9/16}	15	◆ (1) DR1830
W153615 L/R	15	36	15	◆ (1) DR1536
W183615 L/R	18	36	15	◆ (1) DR1836
W154215 L/R	15	41 ^{7/8}	15	◆ (1) DR1542
W184215 L/R	18	41 ^{7/8}	15	◆ (1) DR1842

(2) 15" deep shelves (ADJUSTABLE)

(2) 15" deep shelves (ADJUSTABLE)

(3) 15" deep shelves (ADJUSTABLE)

Wall - Depth: 15" (Double Door) **Frame Construction**

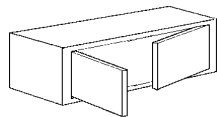

W361215	36	12	15	◆ (2) DR1218
W361515	36	15	15	◆ (2) DR1518
W301815	30	18	15	◆ (2) DR1518
W361815	36	18	15	◆ (2) DR1818

No Shelf

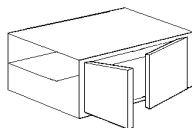

W302415	30	23 ^{5/8}	15	◆ (2) DR1524
W362415	36	23 ^{5/8}	15	◆ (2) DR1824
W303015	30	30 ^{9/16}	15	◆ (2) DR1530
W363015	36	30 ^{9/16}	15	◆ (2) DR1830

(1) 15" deep shelf (ADJUSTABLE)

(2) 15" deep shelves (ADJUSTABLE)

Wall Cabinetry

Wall Cabinets

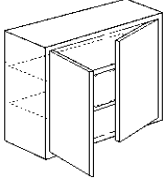
	Width	Height	Depth	Cabinet Doors	Frame Construction	
Wall - Depth 15" (Double Door)						
<i>Available in Carriage House Series Only</i>						
	W303615	30	36	15	◆ (2) DR1536	(2) 15" deep shelves(ASJUSTABLE)
	W363615	36	36	15	◆ (2) DR1836	
	W304215	30	41 ^{7/8}	15	◆ (2) DR1542	(3) 15" deep shelves(ADJUSTABLE)
	W364215	36	41 ^{7/8}	15	◆ (2) DR1842	

	Width	Height	Depth	Cabinet Doors	Frame Construction	
Wall - Depth: 15" (Triple Door)						
	W481215 L/R	48	12	15	◆ (2) DR1612 (1) DR1512	1 Adjustable Shelf (W482415L/R)
	W481815 L/R	48	18	15	◆ (2) DR1618 (1) DR1518	L/R designates hinging of single door
	W482415 L/R	48	24	15	◆ (2) DR1624 (1) DR1524	
	W483015 L/R	48	30	15	◆ (2) DR1630 (1) DR1530	2 Adjustable Shelves

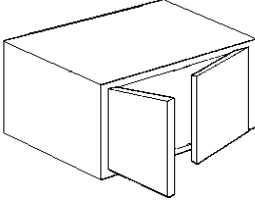
	Width	Height	Depth	Cabinet Doors	Frame Construction	
Wall - Depth: 24" (Double Door)						
	W331224	33	12	24	◆ (2) DR1612	No Shelf
	W361224	36	12	24	◆ (2) DR1812	
	W391224	39	12	24	◆ (2) DR1912	
	W421224	42	12	24	◆ (2) DR2112	
	W331524	33	15	24	◆ (2) DR1615	No Shelf
	W361524	36	15	24	◆ (2) DR1815	
	W391524	39	15	24	◆ (2) DR1915	
	W331824	33	18	24	◆ (2) DR1618	No Shelf
	W361824	36	18	24	◆ (2)DR1818	
	W391824	39	18	24	◆ (2) DR1918	
	W421824	42	18	24	◆ (2) DR2118	
	W332424	33	24	24	◆ (2) DR1624	No Shelf
	W362424	36	24	24	◆ (2) DR1824	
	W392424	39	24	24	◆ (2) DR1924	
W363024	36	30 ^{9/16}	24	◆ (2) DR1830	No Shelf	

	Width	Height	Depth	Cabinet Doors	Frame Construction	
Wall - Depth: 24" (Triple Door)						
	W481224 L/R	48	12	24	◆ (2) DR1612 (1) DR1512	No Shelf
	W481824 L/R	48	18	24	◆ (2) DR1618 (1) DR1518	

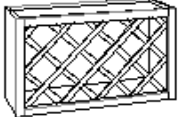
	Width	Height	Depth	Cabinet Doors	Frame Construction	
Wine Rack Lattice - Height: 18"						
	WRL3018	30	18	12		Holds 15 glasses
	WRL3618	36	18	12		Holds 22 glasses Finished Interior

	Width	Height	Depth	Cabinet Doors	Frame Construction	
Wine Rack Diagonal						
	WRD1515	15	15	12		Holds 12 Wine Bottles
	WRD1818	18	18	12		Require that a finished side be called out (VL/VR/VV) for any exposed side Closed Back 5/8" Thick Construction (finished interior)

	Width	Height	Depth	Cabinet Doors	Frame Construction	
Wine Stem Rack						
	WSR3002	30	2	12		Holds 7 glasses
	WSR3602	36	2	12		Holds 9 glasses All Sides Finished

* Installation Note: Trimming is NOT Recommended

Wall Cabinetry

Wall Cabinets

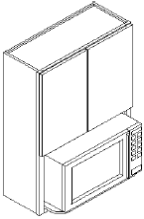
	Width	Height	Depth	Cabinet Doors	Frame Construction	
Wall Microwave Cabinet (Double Doors)						
	MW3030	30	30 ^{9/16}	12	◆ (2) DR1512	Finished Interior Microwave shelf is 16 1/2 inches deep
	MW2436	24	36	12	◆ (2) DR1218	
	MW3036	30	36	12	◆ (2) DR1518	The MW24 opening is 21 3/4" wide and MW30 opening is 27 3/4" wide
	MW2442	24	41 ^{7/8}	12	◆ (2) DR1224	
	MW3042	30	41 ^{7/8}	12	◆ (2) DR1524	
					MW2442/MW3042:1 Adjustable Shelf	

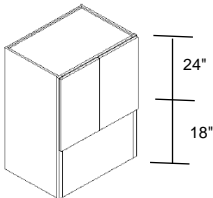
	Width	Height	Depth	Cabinet Doors	Frame Construction	
Counter Depth Coffee Maker Cabinet						
<i>Available in Carriage House Series Only</i>						
	COFC304221	30	42	21	◆ (2) DR1524	No Shelf Overlay Panel Included (OTKF3018)
	COFC306021	30	60	21	◆ (2) DR1530 (1) DH3006	2 Adjustable Shelves Overlay Panel Included (OTKF3024)

	COFC306021	30	60	21	◆ (2) DR1530 (1) DH3006	2 Adjustable Shelves Overlay Panel Included (OTKF3024)
---	-------------------	----	----	----	-------------------------	---

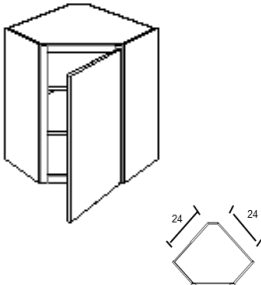
	Width	Height	Depth	Cabinet Doors	Frame Construction	
Wall Corner 24" (Single Door)						
	WC2418 L/R	24	18	24	◆ (1) DR1518	No Shelf
	WC2430 L/R	24	30 ^{9/16}	24	◆ (1) DR1530	2 Adjustable Shelves
	WC2436 L/R	24	36	24	◆ (1) DR1536	
	WC2442 L/R	24	41 ^{7/8}	24	◆ (1) DR1542	3 Adjustable Shelves
	WC2448 L/R	24	48	24	◆ (1) DR1548	WC2448 Available in Carriage House Series Only

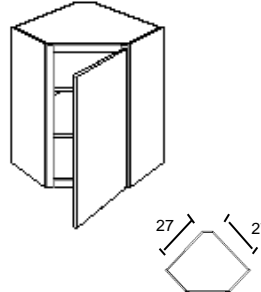
	Width	Height	Depth	Cabinet Doors	Frame Construction	
Wall Corner 27" (Single Door)						
	WC2718 L/R	27	18	27	◆ (1) DR1518	No Shelf
	WC2730 L/R	27	30 ^{9/16}	27	◆ (1) DR1530	2 Adjustable Shelves
	WC2736 L/R	27	36	27	◆ (1) DR1536	
	WC2742 L/R	27	41 ^{7/8}	27	◆ (1) DR1542	3 Adjustable Shelves
	WC2748 L/R	27	48	27	◆ (1) DR1548	

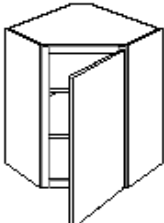
	Width	Height	Depth	Cabinet Doors	Frame Construction	
Wall Corner Lazy Susan 24" (Single Door)						
	WCLS2430 L/R	24	30 ^{9/16}	24	◆ (1) DR1530	(1) Adjustable Shelf with Rotating Lazy Susan Attached
	WCLS2436 L/R	24	36	24	◆ (1) DR1536	(1) Rotating Lazy Susan Attached to Cabinet Bottom
	WCLS2442 L/R	24	41 ^{7/8}	24	◆ (1) DR1542	(2) Adjustable Shelves with Rotating Lazy Susan Attached (1) Rotating Lazy Susan Attached to Cabinet Bottom

Wall Cabinetry

Wall Cabinets

Width Height Depth Cabinet Doors

Wall Corner Lazy Susan 27" (Single Door)

Available in Carriage House Series Only

Frame Construction

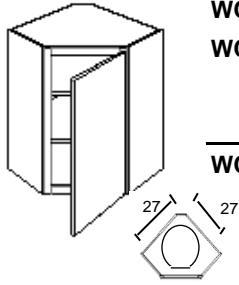

WCLS2730 L/R	27	30 ^{9/16}	24	◆ (1) DR1530
WCLS2736 L/R	27	36	24	◆ (1) DR1536

(1) Adjustable Shelf with Rotating Lazy Susan Attached
(1) Rotating Lazy Susan Attached to Cabinet Bottom

WCLS2742 L/R	27	41 ^{7/8}	24	◆ (1) DR1542
---------------------	----	-------------------	----	--------------

(2) Adjustable Shelves with Rotating Lazy Susan Attached
(1) Rotating Lazy Susan Attached to Cabinet Bottom

Wall Blind Corner - Height: 30"

Frame Construction

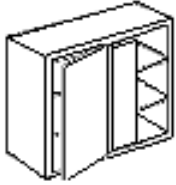

WBC27/3030 L/R	27	30 ^{9/16}	12	◆ (1) DR1230
WBC36/3930 L/R	36	30 ^{9/16}	12	◆ (1) DR2130

2 Adjustable Shelves
3" Corner Overlay Filler INCLUDED
6" Cover overlay Filler ATTACHED (CHS Only)
Closure Panel for Blind Attached
L/R designates position of Blind Side

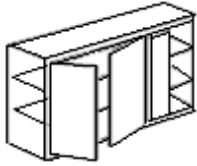

WBC42/4530 L/R	42	30 ^{9/16}	12	◆ (2) DR1330
-----------------------	----	--------------------	----	--------------

2 Adjustable Shelves
3" Corner Overlay Filler INCLUDED
6" Cover overlay Filler ATTACHED (CHS Only)
Closure Panel for Blind Attached
L/R designates position of Blind Side

Cabinet	Cabinet Width	Door Width	Minimum Pull	Maximum Pull
WBC27/3030 L/R	27"	12"	27"	30"
WBC36/3930 L/R	36"	21"	36"	39"
WBC42/4530 L/R	42"	(2) 13"	42"	45"

Wall Blind Corner - Height: 36"

Frame Construction

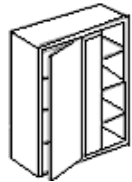

WBC27/3036 L/R	27	36	12	◆ (1) DR1242
WBC36/3936 L/R	36	36	12	◆ (1) DR2142

3 Adjustable Shelves
3" Corner Overlay Filler INCLUDED
6" Cover overlay Filler ATTACHED (CHS Only)
Closure Panel for Blind Attached
L/R designates position of Blind Side

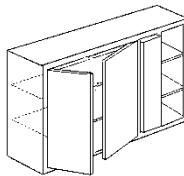

WBC42/4536 L/R	42	36	12	◆ (2) DR1342
-----------------------	----	----	----	--------------

3 Adjustable Shelves
3" Corner Overlay Filler INCLUDED
6" Cover overlay Filler ATTACHED (CHS Only)
Closure Panel for Blind Attached
L/R designates position of Blind Side

Wall Blind Corner - Height: 42"

Frame Construction

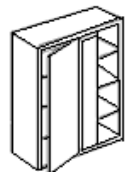

WBC27/3042 L/R	27	41 ^{7/8}	12	◆ (1) DR1242
WBC36/3942 L/R	36	41 ^{7/8}	12	◆ (1) DR2142

3 Adjustable Shelves
3" Corner Overlay Filler INCLUDED
6" Cover overlay Filler ATTACHED (CHS Only)
Closure Panel for Blind Attached
L/R designates position of Blind Side

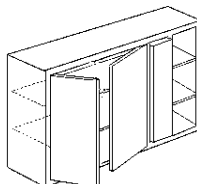

WBC42/4542 L/R	42	41 ^{7/8}	12	◆ (2) DR1342
-----------------------	----	-------------------	----	--------------

3 Adjustable Shelves
3" Corner Overlay Filler INCLUDED
6" Cover overlay Filler ATTACHED (CHS Only)
Closure Panel for Blind Attached

Wall Cabinetry

Wall Cabinets

Width Height Depth Cabinet Doors

Wall End Corner (Double Door)

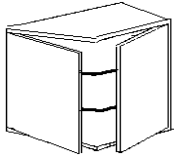

WEC2418 L/R	24	18	12	◆ (2) DR1518	No Shelf
WEC2430 L/R	24	30 ^{9/16}	12	◆ (2) DR1530	2 Fixed Shelves
WEC2436 L/R	24	36	12	◆ (2) DR1536	
WEC2442 L/R	24	41 ^{7/8}	12	◆ (2) DR1542	3 Fixed Shelves

Wall Pie Cut Corner 24"

Full Access Construction

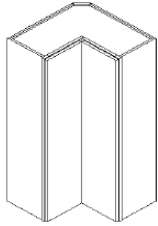

WPC2418 L/R	24	18	24	◆ (2) DR1118	No Shelf
WPC2430 L/R	24	30 ^{9/16}	24	◆ (2) DR1130	2 Adjustable Shelves
WPC2436 L/R	24	36	24	◆ (2) DR1136	Only available in CHS
WPC2442 L/R	24	41 ^{7/8}	24	◆ (2) DR1142	3 Adjustable Shelves
WPC2448 L/R	24	48	24	◆ (2) DR1148	WPC2448 Available in Carriage House Series Only

Wall Drawer - Height: 48" (Single Door)

Frame Construction

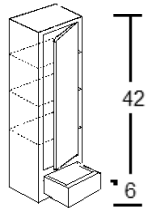

WD1548 L/R	15	48	12	◆ (1) DR1542 (1) DH1506	3 Adjustable Shelves
WD1848 L/R	18	48	12	◆ (1) DR1842 (1) DH1806	Finished Interior STANDARD
					1 Drawer with Full Extension Glides
					Soft Close Glides Not Available

Carriage House Series has (1) DH1505.5 or DH1805.5

Wall Drawer - Height: 48" (Double Door)

Frame Construction

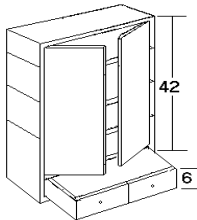

WD3048	30	48	12	◆ (2) DR1542 (2) DH1506	3 Adjustable Shelves
WD3648	36	48	12	◆ (2) DR1842 (2) DH1806	Finished Interior STANDARD
					1 Drawer with Full Extension Glides
					Soft Close Glides Not Available

Carriage House Series has (2) DH1505.5 or DH1805.5

Wall Drawer - Height: 54" (Single Door)

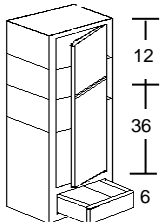

WD1554 L/R	15	54	12	◆ (1) DR1548-WD (1) DH1506	3 Adjustable Shelves
WD1854 L/R	18	54	12	◆ (1) DR1848-WD (1) DH1806	Finished Interior STANDARD
					1 Drawer with Full Extension Glides
					Soft Close Glides Not Available

Carriage House Series has (1) DH1505.5 or DH1805.5

Wall Drawer - Height: 54" (Double Door)

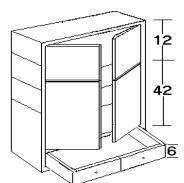

WD3054	30	54	12	◆ (2) DR1548-WD (2) DH1506	3 Adjustable Shelves
WD3654	36	54	12	◆ (2) DR1848-WD (2) DH1806	Finished Interior STANDARD
					1 Drawer with Full Extension Glides
					Soft Close Glides Not Available

Carriage House Series has (2) DH1505.5 or DH1805.5

Wall Cabinetry

Wall Cabinets

Width Height Depth Cabinet Doors

Wall Drawer - Height: 60" (Single Door)

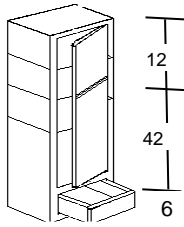

WD1560 L/R	15	60	12	◆ (1) DR1554-WD (1) DH1506	4 Adjustable Shelves
WD1860 L/R	18	60	12	◆ (1) DR1854-WD (1) DH1806	Finished Interior STANDARD 1 Drawer with Full Extension Glides Soft Close Glides Not Available
Carriage House Series has (1) DH1505.5 or DH1805.5					

Wall Drawer - Height: 60" (Double Door)



WD3060	30	60	12	◆ (2) DR1554-WD (2) DH1506	4 Adjustable Shelves
WD3660	36	60	12	◆ (2) DR1854-WD (2) DH1806	Finished Interior STANDARD 1 Drawer with Full Extension Glides Soft Close Glides Not Available
Carriage House Series has (2) DH1505.5 or DH1805.5					

Wall Drawer - Depth: 15" Height: 48" (Single Door)

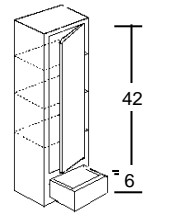

WD154815 L/R	15	48	15	◆ (1) DR1542 (1) DH1506	3 Adjustable 15" Deep Shelves
WD184815 L/R	18	48	15	◆ (1) DR1842 (1) DH1806	Finished Interior STANDARD 1 Drawer with Full Extension Glides Soft Close Glides Not Available
Carriage House Series has (1) DH1505.5 or DH1805.5					

Frame Construction

Wall Drawer - Depth: 15" Height: 48" (Double Door)

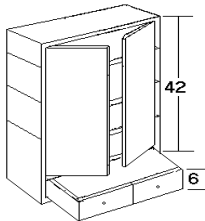

WD304815	30	48	15	◆ (2) DR1542 (2) DH1506	3 Adjustable 15" Deep Shelves
WD364815	36	48	15	◆ (2) DR1842 (2) DH1806	Finished Interior STANDARD 1 Drawer with Full Extension Glides Soft Close Glides Not Available
Carriage House Series has (2) DH1505.5 or DH1805.5					

Wall Drawer - Depth: 15" Height: 54" (Single Door)

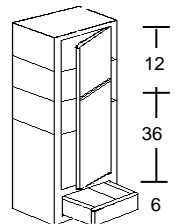

WD155415 L/R	15	54	15	◆ (1) DR1548-WD (1) DH1506	3 Adjustable 15" Deep Shelves
WD185415 L/R	18	54	15	◆ (1) DR1848-WD (1) DH1806	Finished Interior STANDARD 1 Drawer with Full Extension Glides Soft Close Glides Not Available
Carriage House Series has (1) DH1505.5 or DH1805.5					

Wall Drawer - Depth: 15" Height: 54" (Double Door)

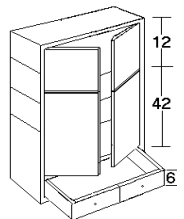

WD305415	30	54	15	◆ (2) DR1548-WD (2) DH1506	3 Adjustable 15" Deep Shelves
WD365415	36	54	15	◆ (2) DR1848-WD (2) DH1806	Finished Interior STANDARD 1 Drawer with Full Extension Glides Soft Close Glides Not Available
Carriage House Series has (2) DH1505.5 or DH1805.5					

Wall Cabinetry

Wall Cabinets

Width Height Depth Cabinet Doors

Wall Drawer - Depth: 15" Height: 60" (Single Door)

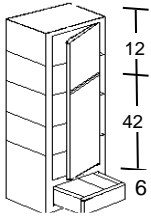

WD156015 L/R	15	60	15	◆ (1) DR1554-WD (1) DH1506	4 Adjustable 15" Deep Shelves
WD186015 L/R	18	60	15	◆ (1) DR1854-WD (1) DH1806	Finished Interior STANDARD 1 Drawer with Full Extension Glides Soft Close Glides Not Available
Carriage House Series has (1) DH1505.5 or DH1805.5					

Wall Drawer - Depth: 15" Height: 60" (Double Door)

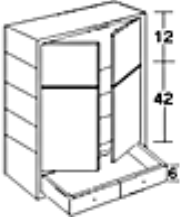

WD306015	30	60	15	◆ (2) DR1554-WD (2) DH1506	4 Adjustable 15" Deep Shelves
WD366015	36	60	15	◆ (2) DR1854-WD (2) DH1806	Finished Interior STANDARD 1 Drawer with Full Extension Glides Soft Close Glides Not Available
Carriage House Series has (2) DH1505.5 or DH1805.5					

Wall Lift-Up

Available in Carriage House Series Only

Frame Construction

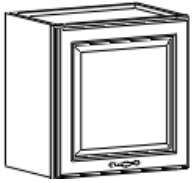

WLIFT1818	18	18	12	◆ (1) DR1818	Open Bottom Door pulls forward and then upwards Interior is finished
WLIFT2418	24	18	12	◆ (1) DR1824	
WLIFT3018	30	18	12	◆ (1) DR1830	
WLIFT3618	36	18	12	◆ (1) DR1836	
WLIFT181815	18	18	15	◆ (1) DR1818	Open Bottom Door pulls forward and then upwards Interior is finished
WLIFT241815	24	18	15	◆ (1) DR1824	
WLIFT301815	30	18	15	◆ (1) DR1830	
WLIFT361815	36	18	15	◆ (1) DR1836	

Cubbies: 6" Wide x 12" Deep

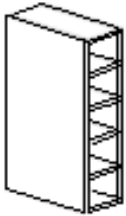

CUB0630	6	30	12		5 Cubbies
CUB0636	6	36	12		6 Cubbies
CUB0642	6	42	12		7 Cubbies 5/8" Framless Construction

Wall Cabinetry

Wall Cabinets

Width Height Depth

Range Hood Tapered

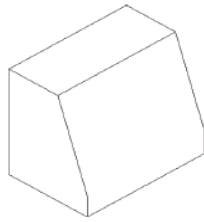

RHT3630	36	30	24
RHT4230	42	30	24
RHT4830	48	30	24
RHT5430	54	30	24
RHT6030	60	30	24

Finished end panels
Alumasteel liner sold separately
** Not doorstyle specific**

Must order RHT-EXT**18-Range Hood Extension separately if needed

Range Hood Extension

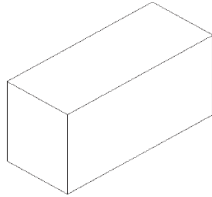

RHT-EXT3618	36	18	15
RHT-EXT4218	42	18	15
RHT-EXT4818	48	18	15
RHT-EXT5418	54	18	15
RHT-EXT6018	60	18	15

Finished end panels
** Not doorstyle specific**

CHIMNEY EXTENSION (DUCT COVER ONLY) MUST ORDER
RHT **30 -RANGE HOOD TAPERED

	A	B
RH3630	36	34-3/4
RH4230	42	40-3/4
RH4830	48	46-3/4
RH5430	54	52-3/4
RH6030	60	58-3/4

(clearance) = available interior for hood liner. Consult your appliance's specifications to confirm dimensions and fit

RHT-EXT**18
EXTENSION
(DUCT COVER)
SOLD SEPARATELY

RHT**30
HOOD

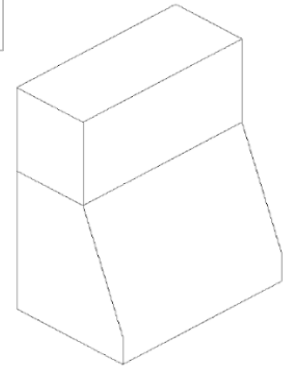
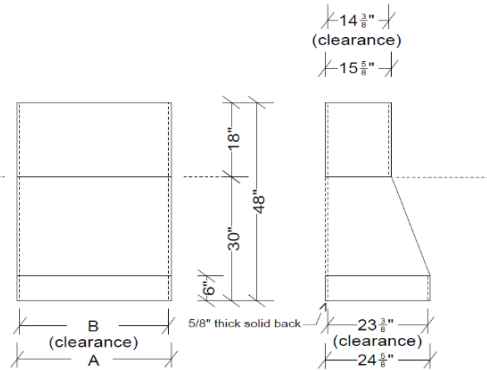

Wall Range Hood

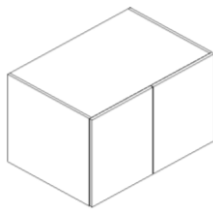

WRH362424	36	24	24	◆ (2) DR1824
WRH363024	36	30	24	◆ (2) DR1830
WRH363624	36	36	24	◆ (2) DR1836
WRH364224	36	42	24	◆ (2) DR1842
WRH422424	42	24	24	◆ (2) DR2124
WRH423024	42	30	24	◆ (2) DR2130
WRH423624	42	36	24	◆ (2) DR2136
WRH424224	42	42	24	◆ (2) DR2142

Cabinet back is held up 6" from bottom to provide more space for hood liner
Finished end panels
Alumasteel panel is included as floor of cabinet recessed 1" from bottom.

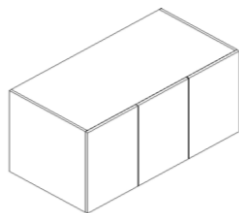

WRH482424	48	24	24	◆ (2) DR1624 (1) DR1524
WRH483024	48	30	24	◆ (2) DR1630 (1) DR1530
WRH483624	48	36	24	◆ (2) DR1636 (1) DR1536
WRH484224	48	42	24	◆ (2) DR1642 (1) DR1542
WRH544224	54	42	24	◆ (2) DR1842

Cabinet back is held up 6" from bottom to provide more space for hood liner
Finished end panels
Alumasteel panel is included as floor of cabinet recessed 1" from bottom

Wall Cabinetry

Wall Cabinets

Range Hood

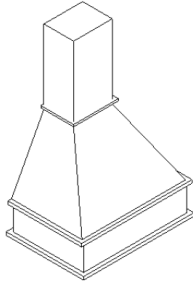

	Width	Height	Depth
RH3630	36	54-1/2	26
RH4230	42	54-1/2	26
RH4830	48	54-1/2	26
RH5430	54	54-1/2	26
RH6030	60	54-1/2	26

24" high chimney extension (duct cover)
*INCLUDED,
Shipped loose / can be trimmed
Alumasteel panel sold separately
Not door style specific

10' CEILING RECOMMENDED TO MAINTAIN
CHIMNEY EXTENSION (DUCT COVER)

	A	B	C
RH3630	36	34-3/4	11-7/8
RH4230	42	40-3/4	17-7/8
RH4830	48	46-3/4	23-7/8
RH5430	54	52-3/4	29-7/8
RH6030	60	58-3/4	35-7/8

(clearance) = available interior for hood liner
Consult your appliance's specifications to
confirm dimensions and fit

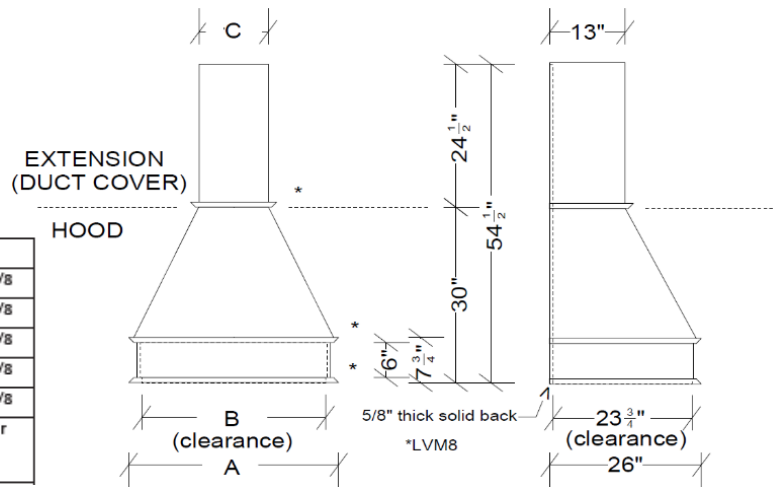

Alumasteel Panel

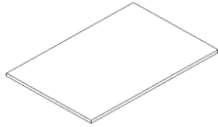

ALMSTL3624	36	3/4	24
ALMSTL4824	48	3/4	24
ALMSTL6024	60	3/4	24

Alumasteel laminated 3/4" partical board

DRFF "Door Face Frame" (Single Door)



	Width	Height	Depth
DRFF1515	15	15	3/4
DRFF1815	18	15	3/4
DRFF1518	15	18	3/4
DRFF1818	18	18	3/4
DRFF1824	18	24	3/4
DRFF0930	9	30 ^{9/16}	3/4
DRFF1530	15	30 ^{9/16}	3/4
DRFF1830	18	30 ^{9/16}	3/4
DRFF2130	21	30 ^{9/16}	3/4
DRFF1236	12	36	3/4
DRFF1536	15	36	3/4
DRFF1836	18	36	3/4
DRFF1542	15	41 ^{7/8}	3/4
DRFF1842	18	41 ^{7/8}	3/4
DRFF2142	21	41 ^{7/8}	3/4

Cabinet Doors

Frame Construction

- ◆ (1) DR1515 Face Frame with doors and hinges attached can be used for Grottos to access duct, fan or motor.
- ◆ (1) DR1815
- ◆ (1) DR1518
- ◆ (1) DR1818
- ◆ (1) DR1824
- ◆ (1) DR0930
- ◆ (1) DR1830
- ◆ (1) DR1830
- ◆ (1) DR2130
- ◆ (1) DR1236
- ◆ (1) DR1536
- ◆ (1) DR1836
- ◆ (1) DR1542
- ◆ (1) DR1842
- ◆ (1) DR2142

Wall Cabinetry

Wall Cabinets

DRFF "Door Face Frame" (Double Door) Frame Construction

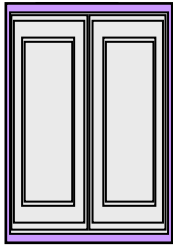

	Width	Height	Depth	Cabinet Doors
DRFF2418	24	18	3/4	◆ (2) DR1218
DRFF2424	24	23 ^{5/8}	3/4	◆ (2) DR1224
DRFF2430	24	30 ^{9/16}	3/4	◆ (2) DR1230
DRFF2730	27	30 ^{9/16}	3/4	◆ (2) DR1330
DRFF2736	27	36	3/4	◆ (2) DR1336
DRFF3012	30	12	3/4	◆ (2) DR1512
DRFF3015	30	15	3/4	◆ (2) DR1515
DRFF3018	30	18	3/4	◆ (2) DR1518
DRFF3024	30	23 ^{5/8}	3/4	◆ (2) DR1524
DRFF3030	30	30 ^{9/16}	3/4	◆ (2) DR1530
DRFF3036	30	36	3/4	◆ (2) DR1536
DRFF3042	30	41 ^{7/8}	3/4	◆ (2) DR1542
DRFF3315	33	15	3/4	◆ (2) DR1615
DRFF3330	33	30 ^{9/16}	3/4	◆ (2) DR1630
DRFF3342	33	41 ^{7/8}	3/4	◆ (2) DR1642
DRFF3612	36	12	3/4	◆ (2) DR1812
DRFF3615	36	15	3/4	◆ (2) DR1815
DRFF3618	36	18	3/4	◆ (2) DR1818
DRFF3624	36	23 ^{5/8}	3/4	◆ (2) DR1824
DRFF3630	36	30 ^{9/16}	3/4	◆ (2) DR1830
DRFF3636	36	36	3/4	◆ (2) DR1836
DRFF3642	36	42	3/4	◆ (2) DR1842
DRFF4212	42	12	3/4	◆ (2) DR2112
DRFF4218	42	18	3/4	◆ (2) DR2118
DRFF4224	42	23 ^{5/8}	3/4	◆ (2) DR2124
DRFF4230	42	30 ^{9/16}	3/4	◆ (2) DR2130
DRFF4236	42	36	3/4	◆ (2) DR2136
DRFF4242	42	41 ^{7/8}	3/4	◆ (2) DR2142

Face Frame with doors and hinges attached can be used for Grottos to access duct, fan or motor.

DRFF "Door Face Frame" (Triple Door) Frame Construction

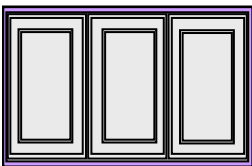

DRFF4812	48	12	3/4	◆ (2) DR1612 (1) DR1512
DRFF4815	48	15	3/4	◆ (2) DR1615 (1) DR1515
DRFF4818	48	18	3/4	◆ (2) DR1618 (1) DR1518
DRFF4824	48	23 ^{5/8}	3/4	◆ (2) DR1624 (1) DR1524
DRFF4830	48	30 ^{9/16}	3/4	◆ (2) DR1630 (1) DR1530
DRFF4836	48	36	3/4	◆ (2) DR1636 (1) DR1536
DRFF4842	48	41 ^{7/8}	3/4	◆ (2) DR1642 (1) DR1542
DRFF5412	54	12	3/4	◆ (3) DR1812
DRFF5418	54	18	3/4	◆ (3) DR1818
DRFF5424	54	23 ^{5/8}	3/4	◆ (3) DR1824
DRFF5430	54	30 ^{9/16}	3/4	◆ (3) DR1830
DRFF5436	54	36	3/4	◆ (3) DR1836
DRFF6024	60	23 ^{5/8}	3/4	◆ (2) DR2124 (1) DR1824
DRFF6030	60	30 ^{9/16}	3/4	◆ (2) DR2130 (1) DR1830
DRFF7218	72	18	3/4	◆ (4) DR1818

Face Frame with doors and hinges attached can be used for Grottos to access duct, fan or motor.

- *Index*
- *Construction Options & Modifications Key*
- *Lite Specifications*
- *Cabinet Selection*

Specialty Wall Cabinetry Mullion Glass, Open Shelf and Bookshelves *All Cabinets in this section have Flush End Panels*

Page Location	Cabinet Type	Nomenclature
59	Construction Options & Modifications Key	
69	Lite Specifications	
60	Wall Open Shelf	WOS
60-61	Wall Book Shelf	WBS
61	What Not Shelf	WNS
62-64	Wall Glass	WG
65-66	Wall Glass - 15" Depth	WG
64-65	Wall Glass - 9" Depth	WG
66	Wall Glass Corner	WGC
67	Wall Glass Drawer	WGD
68	Wall Glass Drawer - 15" Depth	WGD
66	Wall Glass End Corner	WGEC
61	Wall Glass Pie Cut	WGPC
62-64	Wall Mullion	WM
65-66	Wall Mullion - 15" Depth	WM
64-65	Wall Mullion - 9" Depth	WM
66	Wall Mullion Corner	WMC
67	Wall Mullion Drawer	WMD
68	Wall Mullion Drawer - 15" Depth	WMD
66	Wall Mullion End Corner	WMEC

Glass/Mullion Cabinets

Finished Side Codes	
Description	Veneer Code
12" High - Wall	WV12
15" High - Wall	WV15
18" High - Wall	WV18
24" High - Wall	WV24
30" High - Wall	WV30
36" High - Wall	WV36
42" High - Wall	WV42
48" High - Wall	WV48
54" High - Wall	WV54
60" High - Wall	WV60

Cabinet Box Modification Codes	
BOX	Box with no doors or drawer heads
364	Box Only (No drawers/pullouts/doors/drawerheads/shelves/hinges)
BOB	Box Only (No drawers/pullouts/doors/drawerheads/shelves/hinges) With Beaded Back
PLY	Plywood Sides
AWB	All Wood Box

Door Modification Codes	
RGL	Reeded Glass in lieu of Flat on WG and WM cabinets
ASG	All WoodBox/Reeded Glass in Doors
PLG	Plywood Ends/Reeded Glass in Doors
SCH	Soft Close Door Hinges **This option is offered for Gatehouse Series Only
NGL	No Glass inserts in doors for Glass or Mullion Cabinets

Cabinet Component Modification Codes	
BB	Beaded Back

Specialty Wall Cabinetry

Open Shelf Cabinets

Width Height Depth

Wall Open Shelf

Frame Construction

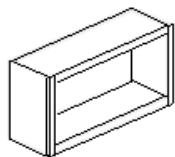

WOS0918	9	18	12
WOS1218	12	18	12
WOS1518	15	18	12
WOS1818	18	18	12
WOS2118	21	18	12
WOS2418	24	18	12
WOS2718	27	18	12
WOS3018	30	18	12
WOS3318	33	18	12
WOS3618	36	18	12

All Wall Open Shelf Cabinets:
 Finished Matching Interior - STANDARD
 5/8": FINISHED END PANELS

 No Adjustable Shelf
 Use instead of glass cabinet without doors
 For beaded interior back use manufacture code "BB"



WOS1530	15	30 ^{9/16}	12
WOS1830	18	30 ^{9/16}	12
WOS3030	30	30 ^{9/16}	12
WOS3630	36	30 ^{9/16}	12

1 Adjustable Shelf
 Use instead of glass cabinet without doors
 For beaded interior back use manufacture code "BB"

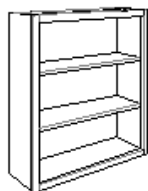

WOS1536	15	36	12
WOS1836	18	36	12
WOS3036	30	36	12
WOS3636	36	36	12
WOS1542	15	41 ^{7/8}	12
WOS1842	18	41 ^{7/8}	12
WOS3042	30	41 ^{7/8}	12
WOS3642	36	41 ^{7/8}	12

2 Adjustable Shelves
 Use instead of glass cabinet without doors
 For beaded interior back use manufacture code "BB"

2 Adjustable Shelves
 Use instead of glass cabinet without doors
 For beaded interior back use manufacture code "BB"

Wall Book Shelf

Available in Carriage House Series Only

Frame Construction



WBS1848	18	48	12
WBS2448	24	48	12
WBS3048	30	48	12
WBS3648	36	48	12

3 Adjustable Shelves
 For beaded interior back use manufacture code "BB"
 Designed to sit on countertop
 4" Top Rail

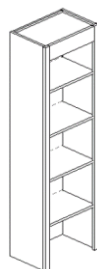

WBS1854	18	54	12
WBS2454	24	54	12
WBS3054	30	54	12
WBS3654	36	54	12
WBS1860	18	60	12
WBS2460	24	60	12
WBS3060	30	60	12
WBS3660	36	60	12

4 Adjustable Shelves
 For beaded interior back use manufacture code "BB"
 Designed to sit on countertop
 4" Top Rail

4 Adjustable Shelves
 For beaded interior back use manufacture code "BB"
 Designed to sit on countertop
 4" Top Rail

Specialty Wall Cabinetry

Wall Bookshelf Cabinets

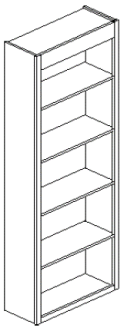
Wall Book Shelf	Width	Height	Depth	Frame Construction	
<i>Available in Carriage House Series Only</i>					
	WBS3078	30	78	12	5 Adjustable Shelves For beaded interior back use manufacture code "BB" (1) 1 7/8" Rail and (1) 4" Rail <i>Can be flipped and installed either way</i>
	WBS3378	33	78	12	
	WBS3678	36	78	12	
	WBS1884	18	84	12	5 Adjustable Shelves For beaded interior back use manufacture code "BB" (1) 1 7/8" Rail and (1) 4" Rail <i>Can be flipped and installed either way</i>
	WBS2484	24	84	12	
	WBS3084	30	84	12	
	WBS3684	36	84	12	
	WBS3090	30	90	12	6 Adjustable Shelves For beaded interior back use manufacture code "BB" (1) 1 7/8" Rail and (1) 4" Rail <i>Can be flipped and installed either way</i>
	WBS3390	33	90	12	
	WBS3690	36	90	12	
	WBS1896	18	96	12	6 Adjustable Shelves For beaded interior back use manufacture code "BB" (1) 1 7/8" Rail and (1) 4" Rail <i>Can be flipped and installed either way</i>
	WBS2496	24	96	12	
	WBS3096	30	96	12	
WBS3696	36	96	12		

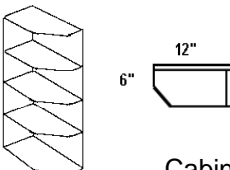
What Not Shelf	Width	Height	Depth	Full Access Construction		
<i>Available in Carriage House Series Only</i>						
	WNS6/12/30	6	30	9/16	12	2 Fixed Shelves
	WNS6/12/36	6	36		12	2 Fixed Shelves
	WNS6/12/42	6	41	7/8	12	3 Fixed Shelves
Cabinet can be "flipped" for right or left handing					12" Side Not Finished Front & Back Edges, Interior & Shelves Finished	

Wall Glass Pie Cut Corner 18"	Width	Height	Depth	Frame Construction
WGPC2418 L/R	24	18	24	◆ (2) DRG1118 No Shelf

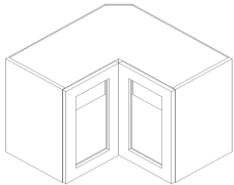

Specialty Wall Cabinetry

All Glass/Mullion Cabinets:
 Finished matching interior - STANDARD
 Must specify VV 5/8" end panels

Glass/Mullion Cabinets

Wall Glass - Height: 15" Frame Construction

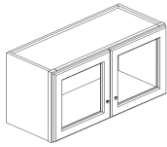

Model	Width	Height	Depth	Cabinet Doors
WG3015	30	15	12	◆ (2) DRG1515
WG3615	36	15	12	◆ (2) DRG1815

No Shelf
 Flat Glass

Wall Glass/Mullion - Height: 18" Frame Construction

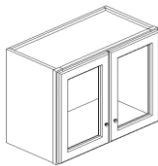

Model	Width	Height	Depth	Cabinet Doors
WG0918 L/R	9	18	12	◆ (1) DRG0918
WG1218 L/R	12	18	12	◆ (1) DRG1218
WG1518 L/R	15	18	12	◆ (1) DRG1518
WG1818 L/R	18	18	12	◆ (1) DRG1818
WG2118 L/R	21	18	12	◆ (1) DRG2118
WG2418	24	18	12	◆ (2) DRG1218
WG2718	27	18	12	◆ (2) DRG1318
WG3018	30	18	12	◆ (2) DRG1518
WG3318	33	18	12	◆ (2) DRG1618
WG3618	36	18	12	◆ (2) DRG1818
WG3918	39	18	12	◆ (2) DRG1918

No Shelf
 Flat Glass

L/R designates hinging of door

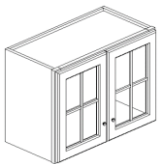

Model	Width	Height	Depth	Cabinet Doors
WM0918 L/R	9	18	12	◆ (1) DRM0918
WM1218 L/R	12	18	12	◆ (1) DRM1218
WM1518 L/R	15	18	12	◆ (1) DRM1518
WM1818 L/R	18	18	12	◆ (1) DRM1818
WM2118 L/R	21	18	12	◆ (1) DRM2118
WM2418	24	18	12	◆ (2) DRM1218
WM2718	27	18	12	◆ (2) DRM1318
WM3018	30	18	12	◆ (2) DRM1518
WM3318	33	18	12	◆ (2) DRM1618
WM3618	36	18	12	◆ (2) DRM1818
WM3918	39	18	12	◆ (2) DRM1918

No Shelf
 Mullion Glass

L/R designates hinging of door

Wall Glass/Mullion - Height: 24" Frame Construction

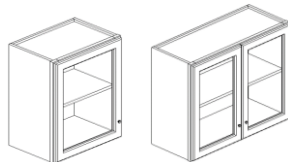

Model	Width	Height	Depth	Cabinet Doors
WG1824 L/R	18	23 ^{5/8}	12	◆ (1) DRG1824
WG3024	30	23 ^{5/8}	12	◆ (2) DRG1524
WG3624	36	23 ^{5/8}	12	◆ (2) DRG1824

1 Adjustable Shelf
 Flat Glass

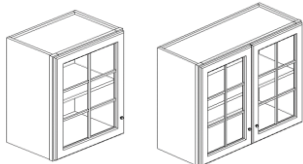

Model	Width	Height	Depth	Cabinet Doors
WM1824 L/R	18	23 ^{5/8}	12	◆ (1) DRM1824
WM3024	30	23 ^{5/8}	12	◆ (2) DRM1524
WM3624	36	23 ^{5/8}	12	◆ (2) DRM1824

1 Adjustable Shelf
 Mullion Glass

Specialty Wall Cabinetry

Glass/Mullion Cabinets

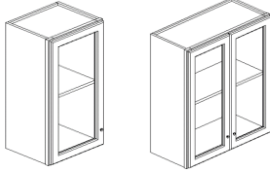
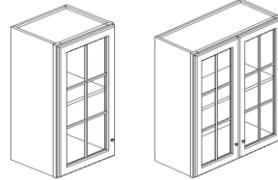
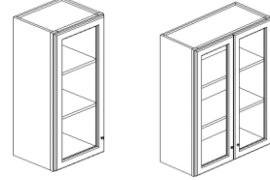
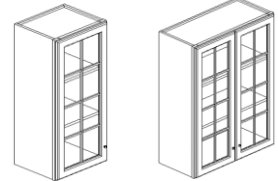
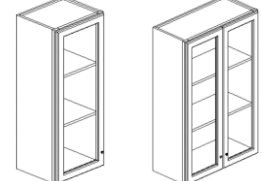
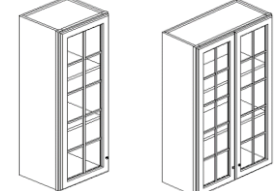
	Width	Height	Depth	Cabinet Doors	Frame Construction	
Wall Glass/Mullion - Height: 30"						
	WG1530 L/R	15	30 ^{9/16}	12	◆ (1) DRG1530	1 Adjustable Shelf Flat Glass
	WG1830 L/R	18	30 ^{9/16}	12	◆ (1) DRG1830	
	WG2130 L/R	21	30 ^{9/16}	12	◆ (1) DRG2130	L/R designates hinging of door
	WG2730	27	30 ^{9/16}	12	◆ (2) DRG1330	
	WG3030	30	30 ^{9/16}	12	◆ (2) DRG1530	
	WG3330	33	30 ^{9/16}	12	◆ (2) DRG1630	
	WG3630	36	30 ^{9/16}	12	◆ (2) DRG1830	
<hr/>						
	WM1530 L/R	15	30 ^{9/16}	12	◆ (1) DRM1530	1 Adjustable Shelf Mullion Glass
	WM1830 L/R	18	30 ^{9/16}	12	◆ (1) DRM1830	
	WM2130 L/R	21	30 ^{9/16}	12	◆ (1) DRM2130	
	WM2730	27	30 ^{9/16}	12	◆ (2) DRM1330	L/R designates hinging of door
	WM3030	30	30 ^{9/16}	12	◆ (2) DRM1530	
	WM3330	33	30 ^{9/16}	12	◆ (2) DRM1630	
	WM3630	36	30 ^{9/16}	12	◆ (2) DRM1830	
<hr/>						
Wall Glass/Mullion - Height: 36"						
	WG1536 L/R	15	36	12	◆ (1) DRG1536	2 Adjustable Shelves Flat Glass
	WG1836 L/R	18	36	12	◆ (1) DRG1836	
	WG2136 L/R	21	36	12	◆ (1) DRG2136	
	WG2736	27	36	12	◆ (2) DRG1336	L/R designates hinging of door
	WG3036	30	36	12	◆ (2) DRG1536	
	WG3336	33	36	12	◆ (2) DRG1636	
	WG3636	36	36	12	◆ (2) DRG1836	
<hr/>						
	WM1536 L/R	15	36	12	◆ (1) DRM1536	2 Adjustable Shelves Mullion Glass
	WM1836 L/R	18	36	12	◆ (1) DRM1836	
	WM2136 L/R	21	36	12	◆ (1) DRM2136	L/R designates hinging of door
	WM2736	27	36	12	◆ (2) DRM1336	
	WM3036	30	36	12	◆ (2) DRM1536	
	WM3336	33	36	12	◆ (2) DRM1636	
	WM3636	36	36	12	◆ (2) DRM1836	
<hr/>						
Wall Glass/Mullion - Height: 42"						
	WG1542 L/R	15	41 ^{7/8}	12	◆ (1) DRG1542	2 Adjustable Shelves Flat Glass
	WG1842 L/R	18	41 ^{7/8}	12	◆ (1) DRG1842	
	WG2142 L/R	21	41 ^{7/8}	12	◆ (1) DRG2142	
	WG2742	27	41 ^{7/8}	12	◆ (2) DRG1342	
	WG3042	30	41 ^{7/8}	12	◆ (2) DRG1542	L/R designates hinging of door
	WG3342	33	41 ^{7/8}	12	◆ (2) DRG1642	
	WG3642	36	41 ^{7/8}	12	◆ (2) DRG1842	
<hr/>						
	WM1542 L/R	15	41 ^{7/8}	12	◆ (1) DRM1542	2 Adjustable Shelves Mullion Glass
	WM1842 L/R	18	41 ^{7/8}	12	◆ (1) DRM1842	
	WM2142 L/R	21	41 ^{7/8}	12	◆ (1) DRM2142	
	WM2742	27	41 ^{7/8}	12	◆ (2) DRM1342	L/R designates hinging of door
	WM3042	30	41 ^{7/8}	12	◆ (2) DRM1542	
	WM3342	33	41 ^{7/8}	12	◆ (2) DRM1642	
	WM3642	36	41 ^{7/8}	12	◆ (2) DRM1842	

Specialty Wall Cabinetry

Glass/Mullion Cabinets

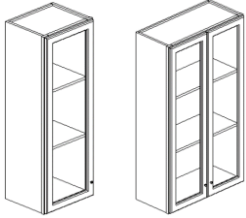
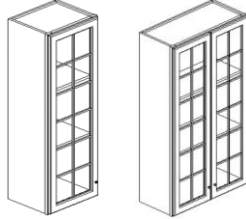
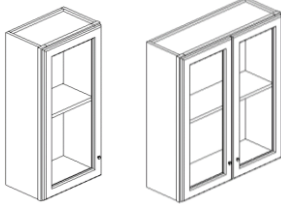
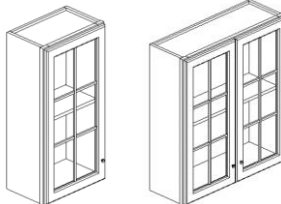
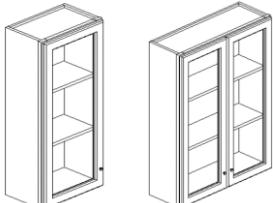
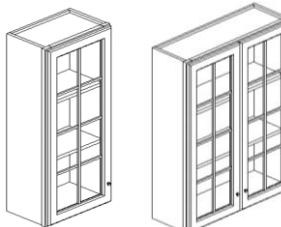
		Width	Height	Depth	Cabinet Doors	Frame Construction
Wall Glass/Mullion - Height: 48"						
<i>Available in Carriage House Series Only</i>						
	WG1548 L/R	15	48	12	◆ (1) DRG1548	2 Adjustable Shelves Flat Glass
	WG1848 L/R	18	48	12	◆ (1) DRG1848	
	WG2148 L/R	21	48	12	◆ (1) DRG2148	L/R designates hinging of door
	WG2748	27	48	12	◆ (2) DRG1348	
	WG3048	30	48	12	◆ (2) DRG1548	
	WG3348	33	48	12	◆ (2) DRG1648	
	WG3648	36	48	12	◆ (2) DRG1848	
	WM1548 L/R	15	48	12	◆ (1) DRM1548	2 Adjustable Shelves Mullion Glass
	WM1848 L/R	18	48	12	◆ (1) DRM1848	
	WM2148 L/R	21	48	12	◆ (1) DRM2148	L/R designates hinging of door
	WM2748	27	48	12	◆ (2) DRM1348	
	WM3048	30	48	12	◆ (2) DRM1548	
	WM3348	33	48	12	◆ (2) DRM1648	
	WM3648	36	48	12	◆ (2) DRM1848	
Wall Glass/Mullion - Height: 30" Depth: 9"						
<i>Frame Construction</i>						
	WG153009 L/R	15	30 9/16"	9	◆ (1) DRG1536	1 Adjustable Shelf Flat Glass
	WG183009 L/R	18	30 9/16"	9	◆ (1) DRG1836	
	WG213009 L/R	21	30 9/16"	9	◆ (1) DRG2136	L/R designates hinging of door
	WG273009	27	30 9/16"	9	◆ (2) DRG1336	
	WG303009	30	30 9/16"	9	◆ (2) DRG1536	
	WG333009	33	30 9/16"	9	◆ (2) DRG1636	
	WG363009	36	30 9/16"	9	◆ (2) DRG1836	
	WM153009 L/R	15	30 9/16"	9	◆ (1) DRM1536	1 Adjustable Shelf Mullion Glass
	WM183009 L/R	18	30 9/16"	9	◆ (1) DRM1836	
	WM213009 L/R	21	30 9/16"	9	◆ (1) DRM2136	L/R designates hinging of door
	WM273009	27	30 9/16"	9	◆ (2) DRM1336	
	WM303009	30	30 9/16"	9	◆ (2) DRM1536	
	WM333009	33	30 9/16"	9	◆ (2) DRM1636	
	WM363009	36	30 9/16"	9	◆ (2) DRM1836	
Wall Glass/Mullion - Height: 36" Depth: 9"						
<i>Frame Construction</i>						
	WG153609 L/R	15	36	9	◆ (1) DRG1536	2 Adjustable Shelves Flat Glass
	WG183609 L/R	18	36	9	◆ (1) DRG1836	
	WG213609 L/R	21	36	9	◆ (1) DRG2136	L/R designates hinging of door
	WG273609	27	36	9	◆ (2) DRG1336	
	WG303609	30	36	9	◆ (2) DRG1536	
	WG333609	33	36	9	◆ (2) DRG1636	
	WG363609	36	36	9	◆ (2) DRG1836	
	WM153609 L/R	15	36	9	◆ (1) DRM1536	2 Adjustable Shelves Mullion Glass
	WM183609 L/R	18	36	9	◆ (1) DRM1836	
	WM213609 L/R	21	36	9	◆ (1) DRM2136	L/R designates hinging of door
	WM273609	27	36	9	◆ (2) DRM1336	
	WM303609	30	36	9	◆ (2) DRM1536	
	WM333609	33	36	9	◆ (2) DRM1636	
	WM363609	36	36	9	◆ (2) DRM1836	

Specialty Wall Cabinetry

Glass/Mullion Cabinets

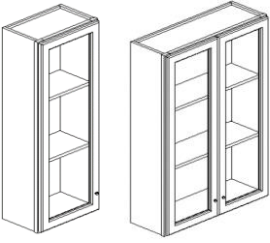
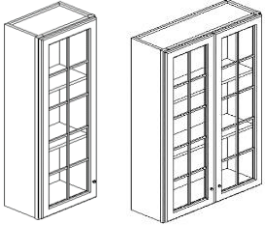
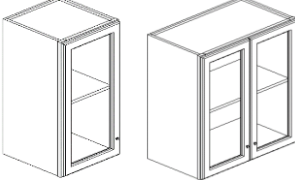
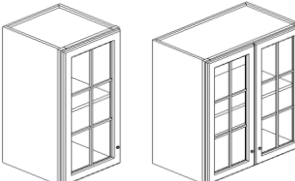
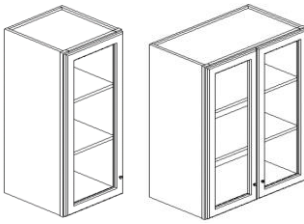
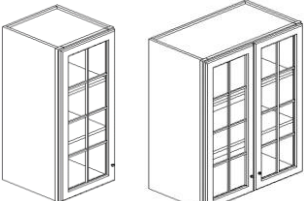
		Width	Height	Depth	Cabinet Doors	
Wall Glass/Mullion - Height: 42" Depth: 9"						
	WG154209 L/R	15	41 ^{7/8}	9	◆ (1) DRG1542	Frame Construction 2 Adjustable Shelves Flat Glass L/R designates hinging of door
	WG184209 L/R	18	41 ^{7/8}	9	◆ (1) DRG1842	
	WG214209 L/R	21	41 ^{7/8}	9	◆ (1) DRG2142	
	WG274209	27	41 ^{7/8}	9	◆ (2) DRG1342	
	WG304209	30	41 ^{7/8}	9	◆ (2) DRG1542	
	WG334209	33	41 ^{7/8}	9	◆ (2) DRG1642	
	WG364209	36	41 ^{7/8}	9	◆ (2) DRG1842	
	WM154209 L/R	15	41 ^{7/8}	9	◆ (1) DRM1542	Frame Construction 2 Adjustable Shelves Mullion Glass L/R designates hinging of door
	WM184209 L/R	18	41 ^{7/8}	9	◆ (1) DRM1842	
	WM214209 L/R	21	41 ^{7/8}	9	◆ (1) DRM2142	
	WM274209	27	41 ^{7/8}	9	◆ (2) DRM1342	
	WM304209	30	41 ^{7/8}	9	◆ (2) DRM1542	
	WM334209	33	41 ^{7/8}	9	◆ (2) DRM1642	
	WM364209	36	41 ^{7/8}	9	◆ (2) DRM1842	
Wall Glass/Mullion - Height: 30" Depth: 15"						
	WG153015 L/R	15	30 9/16'	15	◆ (1) DRG1530	Frame Construction 1 Adjustable Shelf 15" Deep Flat Glass L/R designates hinging of door
	WG183015 L/R	18	30 9/16'	15	◆ (1) DRG1830	
	WG213015 L/R	21	30 9/16'	15	◆ (1) DRG2130	
	WG273015	27	30 9/16'	15	◆ (2) DRG1330	
	WG303015	30	30 9/16'	15	◆ (2) DRG1530	
	WG333015	33	30 9/16'	15	◆ (2) DRG1630	
	WG363015	36	30 9/16'	15	◆ (2) DRG1830	
	WM153015 L/R	15	30 9/16'	15	◆ (1) DRM1530	Frame Construction 1 Adjustable Shelf 15" deep Mullion Glass L/R designates hinging of door
	WM183015 L/R	18	30 9/16'	15	◆ (1) DRM1830	
	WM213015 L/R	21	30 9/16'	15	◆ (1) DRM2130	
	WM273015	27	30 9/16'	15	◆ (2) DRM1330	
	WM303015	30	30 9/16'	15	◆ (2) DRM1530	
	WM333015	33	30 9/16'	15	◆ (2) DRM1630	
	WM363015	36	30 9/16'	15	◆ (2) DRM183.	
Wall Glass/Mullion - Height: 36" Depth: 15"						
	WG153615 L/R	15	36	15	◆ (1) DRG1536	Frame Construction 2 Adjustable Shelves 15" deep Flat Glass L/R designates hinging of door
	WG183615 L/R	18	36	15	◆ (1) DRG1836	
	WG213615 L/R	21	36	15	◆ (1) DRG2136	
	WG273615	27	36	15	◆ (2) DRG1336	
	WG303615	30	36	15	◆ (2) DRG1536	
	WG333615	33	36	15	◆ (2) DRG1636	
	WG363615	36	36	15	◆ (2) DRG1836	
	WM153615 L/R	15	36	15	◆ (1) DRM1536	Frame Construction 2 Adjustable Shelves 15" Deep Mullion Glass L/R designates hinging of door
	WM183615 L/R	18	36	15	◆ (1) DRM1836	
	WM213615 L/R	21	36	15	◆ (1) DRM2136	
	WM273615	27	36	15	◆ (2) DRM1336	
	WM303615	30	36	15	◆ (2) DRM1536	
	WM333615	33	36	15	◆ (2) DRM1636	
	WM363615	36	36	15	◆ (2) DRM1836	

Specialty Wall Cabinetry

Glass/Mullion Cabinets

Width Height Depth Cabinet Doors

Wall Glass/Mullion - Height: 42" Depth: 15"

Frame Construction

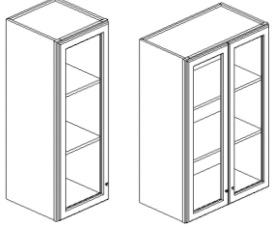
	WG154215 L/R	15	41 ^{7/8}	15	◆ (1) DRG1542	2 Adjustable Shelves Flat Glass
	WG184215 L/R	18	41 ^{7/8}	15	◆ (1) DRG1842	
	WG214215 L/R	21	41 ^{7/8}	15	◆ (1) DRG2142	
	WG274215	27	41 ^{7/8}	15	◆ (2) DRG1342	
	WG304215	30	41 ^{7/8}	15	◆ (2) DRG1542	
	WG334215	33	41 ^{7/8}	15	◆ (2) DRG1642	
	WG364215	36	41 ^{7/8}	15	◆ (2) DRG1842	

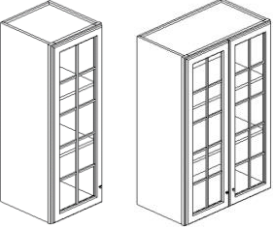
	WM154215 L/R	15	41 ^{7/8}	15	◆ (1) DRM1542	2 Adjustable Shelves Mullion Glass
	WM184215 L/R	18	41 ^{7/8}	15	◆ (1) DRM1842	
	WM214215 L/R	21	41 ^{7/8}	15	◆ (1) DRM2142	
	WM274215	27	41 ^{7/8}	15	◆ (2) DRM1342	
	WM304215	30	41 ^{7/8}	15	◆ (2) DRM1542	
	WM334215	33	41 ^{7/8}	15	◆ (2) DRM1642	
	WM364215	36	41 ^{7/8}	15	◆ (2) DRM1842	

Wall Glass/Mullion Corner (Single Door)

Frame Construction

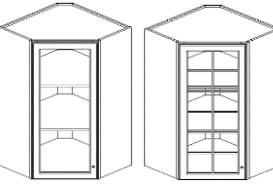
	WGC2418 L/R	24	18	24	◆ (1) DRG1518	No Shelf
	WGC2430 L/R	24	30 ^{9/16}	24	◆ (1) DRG1530	1 Adjustable Shelf
	WGC2436 L/R	24	36	24	◆ (1) DRG1536	2 Adjustable Shelves
	WGC2442 L/R	24	41 ^{7/8}	24	◆ (1) DRG1542	2 Adjustable Shelves
	WGC2448 L/R	24	48	24	◆ (1) DRG1548	3 Adjustable Shelves
	WMC2418 L/R	24	18	24	◆ (1) DRM1518	No Shelf
	WMC2430 L/R	24	30 ^{9/16}	24	◆ (1) DRM1530	1 Adjustable Shelf
	WMC2436 L/R	24	36	24	◆ (1) DRM1536	2 Adjustable Shelves
	WMC2442 L/R	24	41 ^{7/8}	24	◆ (1) DRM1542	2 Adjustable Shelves
	WMC2448 L/R	24	48	24	◆ (1) DRM1548	3 Adjustable Shelves

Cannot do bead board interior

Wall Glass/Mullion Corner 27" (Single Door)

Frame Construction

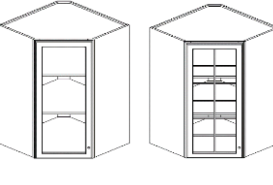
	WGC2718 L/R	27	18	27	◆ (1) DRG1518	No Shelf
	WGC2730 L/R	27	30 ^{9/16}	27	◆ (1) DRG1530	1 Adjustable Shelf
	WGC2736 L/R	27	36	27	◆ (1) DRG1536	2 Adjustable Shelves
	WGC2742 L/R	27	41 ^{7/8}	27	◆ (1) DRG1542	2 Adjustable Shelves
	WGC2748 L/R	27	48	27	◆ (1) DRG1548	3 Adjustable Shelves
	WMC2718 L/R	27	18	27	◆ (1) DRM1518	No Shelf
	WMC2730 L/R	27	30 ^{9/16}	27	◆ (1) DRM1530	1 Adjustable Shelf
	WMC2736 L/R	27	36	27	◆ (1) DRM1536	2 Adjustable Shelves
	WMC2742 L/R	27	41 ^{7/8}	27	◆ (1) DRM1542	2 Adjustable Shelves
	WMC2748 L/R	27	48	27	◆ (1) DRM1548	3 Adjustable Shelves

Cannot do bead board interior

Wall Glass/Mullion End Corner 24" (Double Door)

Frame Construction

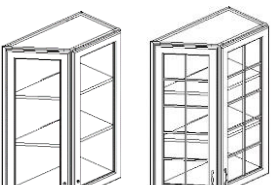
	WGEC2418 L/R	24	18	12	◆ (1) DRG1518	No Shelf
	WGEC2430 L/R	24	30 ^{9/16}	12	◆ (2) DRG1530	1 Fixed Shelf
	WGEC2436 L/R	24	36	12	◆ (2) DRG1536	2 Fixed Shelves
	WGEC2442 L/R	24	41 ^{7/8}	12	◆ (2) DRG1542	2 Fixed Shelves
	WMEC2418 L/R	24	18	12	◆ (1) DRM1518	No Shelf
	WMEC2430 L/R	24	30 ^{9/16}	12	◆ (2) DRM1530	1 Fixed Shelf
	WMEC2436 L/R	24	36	12	◆ (2) DRM1536	2 Fixed Shelves
WMEC2442 L/R	24	41 ^{7/8}	12	◆ (2) DRM1542	2 Fixed Shelves	

Cannot do bead board interior

Specialty Wall Cabinetry

Glass/Mullion Cabinets

Wall Glass/Mullion Drawer - Height: 48" (Single Door)

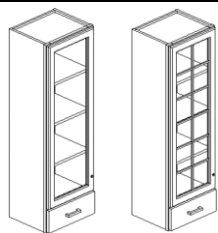

	Width	Height	Depth	Cabinet Doors
WGD1548 L/R	15	48	12	◆ (1) DRG1542 (1) DH1505.5
WGD1848 L/R	18	48	12	◆ (1) DRG1842 (1) DH1805.5
WMD1548 L/R	15	48	12	◆ (1) DRM1542 (1) DH1505.5
WMD1848 L/R	18	48	12	◆ (1) DRM1842 (1) DH1805.5

Frame Construction

3 Adjustable Shelves
1 Drawer with Full Extension
Glides
Flat Glass

3 Adjustable Shelves
1 Drawer with Full Extension
Glides
Mullion Glass

** Soft Close Glides NOT Available

Carriage House Series has (1) DH1505.5 or DH 1805.5

Wall Glass/Mullion Drawer - Height: 48" (Double Door)

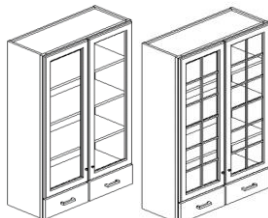

	Width	Height	Depth	Cabinet Doors
WGD3048	30	48	12	◆ (1) DRG1542 (1) DH1505.5
WGD3648	36	48	12	◆ (1) DRG1842 (1) DH1805.5
WMD3048	30	48	12	◆ (1) DRM1542 (1) DH1505.5
WMD3648	36	48	12	◆ (1) DRM1842 (1) DH1805.5

Frame Construction

3 Adjustable Shelves
Flat Glass

3 Adjustable Shelves
Mullion Glass

** Soft Close Glides NOT Available

Carriage House Series has (2) DH1505.5 or DH 1805.5

Wall Glass/Mullion Drawer - Height: 54" (Single Door)

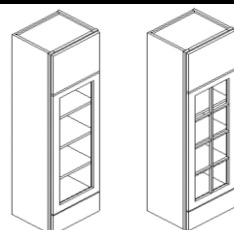

	Width	Height	Depth	Cabinet Doors
WGD1554 L/R	15	54	12	◆ (1) DRG1548-WD (1) DH1506
WGD1854 L/R	18	54	12	◆ (1) DRG1848-WD (1) DH1806
WMD1554 L/R	15	54	12	◆ (1) DRM1548-WD (1) DH1506
WMD1854 L/R	18	54	12	◆ (1) DRM1848-WD (1) DH1806

Frame Construction

3 Adjustable Shelves
1 Drawer with Full Extension
Glides
Flat Glass

3 Adjustable Shelves
1 Drawer with Full Extension
Glides
Mullion Glass

** Soft Close Glides NOT Available

Wall Glass/Mullion Drawer - Height: 54" (Double Door)

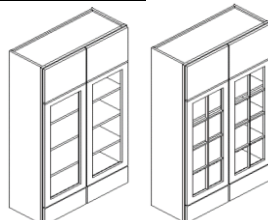

	Width	Height	Depth	Cabinet Doors
WGD3054	30	54	12	◆ (2) DRG1548-WD (2) DH1506
WGD3654	36	54	12	◆ (2) DRG1848-WD (2) DH1806
WMD3054	30	54	12	◆ (2) DRM1548-WD (2) DH1506
WMD3654	36	54	12	◆ (2) DRM1848-WD (2) DH1806

Frame Construction

3 Adjustable Shelves
Flat Glass

3 Adjustable Shelves
Mullion Glass

** Soft Close Glides NOT Available

Wall Glass/Mullion Drawer - Height: 60" (Single Door)

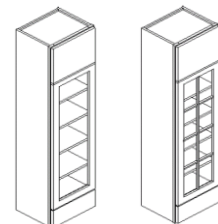

	Width	Height	Depth	Cabinet Doors
WGD1560 L/R	15	60	12	◆ (1) DRG1554-WD (1) DH1506
WGD1860 L/R	18	60	12	◆ (1) DRG1854-WD (1) DH1806
WMD1560 L/R	15	60	12	◆ (1) DRM1554-WD (1) DH1506
WMD1860 L/R	18	60	12	◆ (1) DRM1854-WD (1) DH1806

Frame Construction

4 Adjustable Shelves
1 Drawer with Full Extension
Glides
Flat Glass

4 Adjustable Shelves
1 Drawer with Full Extension
Glides
Mullion Glass

** Soft Close Glides NOT Available

Wall Glass/Mullion Drawer - Height: 60" (Double Door)

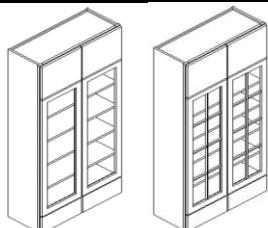

	Width	Height	Depth	Cabinet Doors
WGD3060	30	60	12	◆ (2) DRG1554-WD (2) DH1506
WGD3660	36	60	12	◆ (2) DRG1854-WD (2) DH1806
WMD3060	30	60	12	◆ (2) DRM1554-WD (2) DH1506
WMD3660	36	60	12	◆ (2) DRM1854-WD (2) DH1806

Frame Construction

4 Adjustable Shelves
1 Drawer with Full Extension
Glides
Flat Glass

4 Adjustable Shelves
1 Drawer with Full Extension
Glides
Mullion Glass

** Soft Close Glides NOT Available

Specialty Wall Cabinetry

Glass/Mullion Cabinets

Wall Glass/Mullion Drawer - Height: 48" Depth: 15" (Single Door)

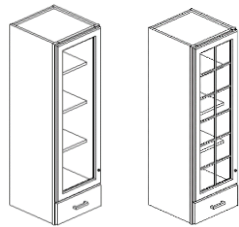

Model	Width	Height	Depth	Cabinet Doors
WGD154815 L/R	15	48	15	◆ (1) DRG1542 (1) DH1505.5
WGD184815 L/R	18	48	15	◆ (1) DRG1842 (1) DH1805.5
WMD154815 L/R	15	48	15	◆ (1) DRM1542 (1) DH1505.5
WMD184815 L/R	18	48	15	◆ (1) DRM1842 (1) DH1805.5

Frame Construction

3 Adjustable Shelves
1 Drawer with Full Extension
Glides
Flat Glass

3 Adjustable Shelves
1 Drawer with Full Extension
Glides
Mullion Glass

** Soft Close Glides NOT Available

Carriage House Series has (1) DH1505.5 or DH1805.5

Wall Glass/Mullion Drawer - Height: 48" Depth: 15" (Double Door)

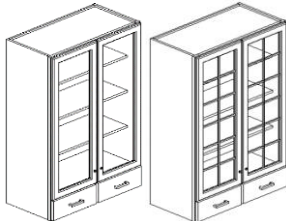

Model	Width	Height	Depth	Cabinet Doors
WGD304815	30	48	15	◆ (2) DRG1542 (2) DH1505.5
WGD364815	36	48	15	◆ (2) DRG1842 (2) DH1805.5
WMD304815	30	48	15	◆ (2) DRM1542 (2) DH1505.5
WMD364815	36	48	15	◆ (2) DRM1842 (2) DH1805.5

Frame Construction

3 Adjustable Shelves
Flat Glass

3 Adjustable Shelves
Flat Glass

** Soft Close Glides NOT Available

Wall Glass/Mullion Drawer - Height: 54" Depth: 15" (Single Door)

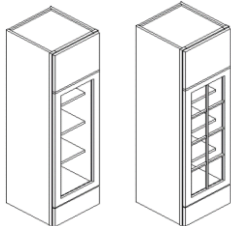

Model	Width	Height	Depth	Cabinet Doors
WGD155415 L/R	15	54	15	◆ (1) DRG1548-WD (1) DH1506
WGD185415 L/R	18	54	15	◆ (1) DRG1848-WD (1) DH1806
WMD155415 L/R	15	54	15	◆ (1) DRM1548-WD (1) DH1506
WMD185415 L/R	18	54	15	◆ (1) DRM1848-WD (1) DH1806

Frame Construction

3 Adjustable Shelves
1 Drawer with Full Extension
Glides
Flat Glass

3 Adjustable Shelves
1 Drawer with Full Extension
Glides
Flat Glass

** Soft Close Glides NOT Available

Wall Glass/Mullion Drawer - Height: 54" Depth: 15" (Double Door)

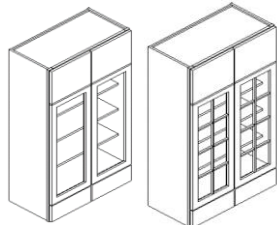

Model	Width	Height	Depth	Cabinet Doors
WGD305415	30	54	15	◆ (2) DRG1548-WD (2) DH1506
WGD365415	36	54	15	◆ (2) DRG1848-WD (2) DH1806
WMD305415	30	54	15	◆ (2) DRM1548-WD (2) DH1506
WMD365415	36	54	15	◆ (2) DRM1848-WD (2) DH1806

Frame Construction

3 Adjustable Shelves
Flat Glass

3 Adjustable Shelves
Mullion Glass

** Soft Close Glides NOT Available

Wall Glass/Mullion Drawer - Height: 60" Depth: 15" (Single Door)

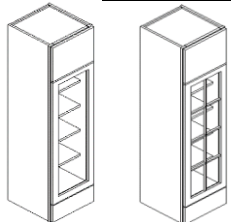

Model	Width	Height	Depth	Cabinet Doors
WGD156015 L/R	15	60	15	◆ (1) DRG1554-WD (1) DH1506
WGD186015 L/R	18	60	15	◆ (1) DRG1854-WD (1) DH1806
WMD156015 L/R	15	60	15	◆ (1) DRM1554-WD (1) DH1506
WMD186015 L/R	18	60	15	◆ (1) DRM1854-WD (1) DH1806

Frame Construction

4 Adjustable Shelves
1 Drawer with Full Extension
Glides
Flat Glass

4 Adjustable Shelves
1 Drawer with Full Extension
Glides
Mullion Glass

** Soft Close Glides NOT Available

Wall Glass/Mullion Drawer - Height: 60" Depth: 15" (Double Door)

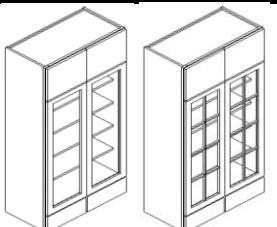

Model	Width	Height	Depth	Cabinet Doors
WGD306015	30	60	15	◆ (2) DRG1554-WD (2) DH1506
WGD366015	36	60	15	◆ (2) DRG1854-WD (2) DH1806
WMD306015	30	60	15	◆ (2) DRM1554-WD (2) DH1506
WMD366015	36	60	15	◆ (2) DRM1854-WD (2) DH1806

Frame Construction

4 Adjustable Shelves
Flat Glass

4 Adjustable Shelves
Mullion Glass

** Soft Close Glides NOT Available

Specialty Wall Cabinetry

Lite Specifications

Wall Mullion					
18" High 4-Lites	24" High 6-Lites	30" High 8-Lites	36" High 10-Lites	42" High 12-Lites	48" High 14-Lites
Wall Mullion Drawer					
42" High door On WMD**48		48" High door On WMD**54		54" High door On WMD**60	
12-Lites		10-Lites		12-Lites	
<p>Showing one-panel door and drawer</p>		<p>Showing two-panel door and drawer</p>		<p>Showing two-panel door and drawer</p>	

TAB: Base Cabinetry

- *Index*
- *Construction Options & Modifications Key*
- *Cabinet Selection*
- *Frame with Doors*

Base Cabinetry

Page Location	Cabinet Type	Nomenclature
72	Construction Options & Modifications Key	
73	Base	B
83	Base - 21" Depth	B-21
81	Base with 2 Pullouts	B-2T
75	Base 4 Drawer	B4D
76	Base Basket	BBAS
79	Base Blind Corner	BBC
79	Base Blind Corner Full Height	BBCFH
79	Base Blind Corner Full Height Swing Out	BBCFHSO
79	Base Blind Corner Swing Out	BBCSO
83	Base Blind Corner Full Height with 2 Pullouts	BBCFH-2T
80	Base Chrysler (45° Cabinet)	BC
75	Base Cooktop	BCT
80	Base Corner	BC
79	Base Corner Shelf	BCS
75	Base Deep Drawer	BDD
75	Base Drawer	BD
77	Base Drawer - ADA	BD-ADA
76	Base Drawer (Combo)	BD
76	Base Drawer Cooktop	BDCT
82	Base Drawer (Combo) with 2 Pullouts	BD-2T
76	Base Drawer Range Top	BDRT
81	Base End Corner	BEC
81	Base End Unit	BEU
81	Base End Unit Open Shelf	BEUOS
81	Base End Unit Wine Rack	BEUWR
73-74	Base Full Height	BFH
83	Base Full Height - 21" Depth	BFH-21
82	Base Full Height with 2 Pullouts	BFH-2T
79	Base Lazy Susan	BLS
80	Base Lazy Susan with Upgraded Tray	BLSU
75	Base Microwave	BMW
76	Base Mixer Cabinet	BMX
74	Base Pull Out	BPO
74	Base Pull Out with Canisters	BPOC
74	Base Trash Cabinet	BTC
75	Base Trash Cabinet Full Height	BTCFH
73	Base Tray	BT
75	Cooktop Base	CTB
82	Cooktop Base with 2 Pullouts	CTB-2T
84	Door Face Frame Base (DRFFB)	DRFFB
78	Farm Sink Front	FSF
76-77	Sink Base	SB
78	Sink Base Base (Combo)	SBB
78	Sink Base Drawer (Combo)	SBD
78	Sink Base Drawer Full Height (Combo)	SBDFH
78	Sink Base Farm Sink	SBFS
77	Sink Base Full Height	SBFH
77	Sink Base Full Height Removable Front - ADA	SBFHFRF-ADA
78	Sink Base Trash Cabinet (Combo)	SBTC
78	Sink Base Trash Cabinet Full Height (Combo)	SBTCFH
80	Sink Floor	SFD FLOOR
80	Sink Front Diagonal	SFD
80	Sink Front Diagonal Full Height	SFDFH

Base Cabinetry

Base Cabinets

Finished Side Codes

Description	Veneer Code
34 1/2" High Base/Vanity	BV34

Cabinet Box Modification Codes

BOX	Box with no doors or no drawer heads
364	Box Only (No drawers/pullouts/doors/drawerheads/shelves/hinges)
PLY	Plywood Sides
AWB	All Wood Box

Cabinet Component Modification Codes

NTK	No Toekick Assembly
-----	---------------------

Drawer / Pullout Modification Codes

DTG	Dovetail Drawer/Full Extension Soft Close Glides <i>*Gatehouse Series Only*</i>
GPO	Pullout instead of Half Shelf in Gatehouse Series <i>*This option is offered for Gatehouse Series Only: 21" deep pullout (middle position only)*</i>
FAP	Full Access Pullout <i>Only available for middle position pullouts</i> <i>*This option is offered for Carriage House Series Only*</i>

Door / Drawer Front Modification Codes

SCH	Soft Close Door Hinges <i>*This option is offered for Gatehouse Series Only*</i>
-----	---

Base Cabinetry

Base Cabinets

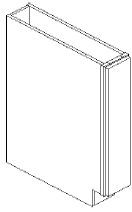
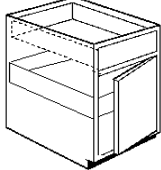
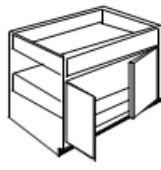
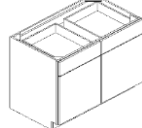
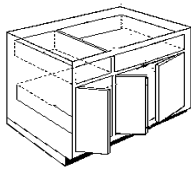
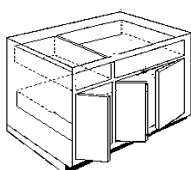
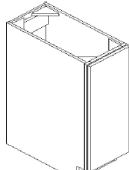
	Width	Height	Depth	Cabinet Door and Drawer Head		Frame Construction
Base Tray (Single Door)						
	BT6 L/R	6	34 1/2	24	◆ (1) DR0630	BT6 Uses Drawer Front to Match Selected Drawer Style
	BT9 L/R	9	34 1/2	24	◆ (1) DR0930	BT9 Uses Door to Match Selected Door Style
	BT12 L/R	12	34 1/2	24	◆ (1) DR1230	BT12 Comes with Center Tray Divider No Drawer or Pullout Tray
Base (Single Door)						
	B12 L/R	12	34 1/2	24	◆ (1) DR1224 (1) DH1206	(1) Drawer (1) Pullout Tray (CHS)
	B15 L/R	15	34 1/2	24	◆ (1) DR1524 (1) DH1506	(1) Half Shelf (GHS)
	B18 L/R	18	34 1/2	24	◆ (1) DR1824 (1) DH1806	
	B21 L/R	21	34 1/2	24	◆ (1) DR2124 (1) DH2106	
Base (Double Door)						
	B24	24	34 1/2	24	◆ (2) DR1224 (1) DH2406	(1) Drawer (1) Pullout Tray (CHS)
	B27	27	34 1/2	24	◆ (2) DR1324 (1) DH2706	(1) Half Shelf (GHS)
	B30	30	34 1/2	24	◆ (2) DR1524 (1) DH3006	
	B33	33	34 1/2	24	◆ (2) DR1624 (1) DH3306	
	B36	36	34 1/2	24	◆ (2) DR1824 (1) DH3606	
	B42	42	34 1/2	24	◆ (2) DR2124 (2) DH2106	(2) Drawers (2) Pullout Trays (CHS) (1) Half Shelf (GHS) 2 1/4" Center Stile
Base (Triple Door)						
	B39 L/R	39	34 1/2	24	◆ (1) DR1224 (2) DR1324 (1) DH1206 (1) DH2706	(2) Drawers (2) Pullout Trays (CHS) GHS has (1) Half Shelf instead of Pullout L/R designates position of single door and 2 1/4" stile placement
	B45 L/R	45	34 1/2	24	◆ (3) DR1524 (1) DH3006 (1) DH1506	(2) Pullout Trays (CHS) (2) Drawers
	B48 L/R	48	34 1/2	24	◆ (2) DR1624 (1) DR1524 (1) DH3306 (1) DH1506	L/R designates position of single door and 2 1/4" stile placement
	B54 L/R	54	34 1/2	24	◆ (3) DR1824 (1) DH3606 (1) DH1806	(2) Half Shelves (GHS)
<i>*image shown as left</i>						
Base Full Height (Single Door)						
	BFH12 L/R	12	34 1/2	24	◆ (1) DR1230	(1) Pullout Tray (CHS)
	BFH15 L/R	15	34 1/2	24	◆ (1) DR1530	(1) Half Shelf (GHS)
	BFH18 L/R	18	34 1/2	24	◆ (1) DR1830	
	BFH21 L/R	21	34 1/2	24	◆ (1) DR2130	

Base Cabinetry

Base Cabinets

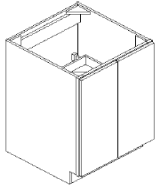
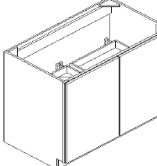
	Width	Height	Depth	Cabinet Door and Drawer Head	Frame Construction	
Base Full Height (Double Door)						
	BFH24	24	34 1/2	24	◆ (2) DR1230	(1) Pullout Tray (CHS) (1) Half Shelf (GHS)
	BFH27	27	34 1/2	24	◆ (2) DR1330	
	BFH30	30	34 1/2	24	◆ (2) DR1530	
	BFH33	33	34 1/2	24	◆ (2) DR1630	
	BFH36	36	34 1/2	24	◆ (2) DR1830	
	BFH42	42	34 1/2	24	◆ (2) DR2130	(2) Pullout Trays (CHS) 2 1/4" Center Stile (1) Half Shelf (GHS)

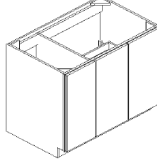
	Width	Height	Depth	Cabinet Door and Drawer Head	Frame Construction	
Base Full Height (Triple Door)						
	BFH39 L/R	39	34 1/2	24	◆ (1) DR1230 (2) DR1330	(2) Pullout Trays (CHS) L/R designates hinging of single door (1) Half Shelf (GHS)
	<i>*image shown as left</i>					

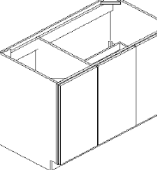
	BFH45 L/R	45	34 1/2	24	◆ (3) DR1530	(2) Pullout Trays (CHS) L/R designates hinging of single door
	BFH48 L/R	48	34 1/2	24	◆ (2) DR1630 (1) DR1530	(2) Half Shelves (GHS)
	BFH54 L/R	54	34 1/2	24	◆ (3) DR1830	
<i>*image shown as left</i>						

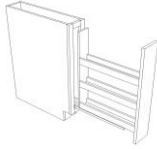
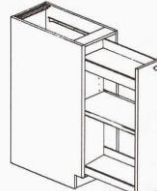
	Width	Height	Depth	Cabinet Door and Drawer Head	Full Access Construction	
Base Pull Out						
	BPO6	6	34 1/2	24	◆ (1) DR0630	(1) Door Top and Bottom Spice Racks are "Fixed" Middle Spice Rack is Adjustable End Panels are flush on both sides Uses Drawer Front to Match Selected Drawer Style Soft Close Glides Not Available
	<i>* Installation Notes: Recommended to install next to OR between cabinets due to stability concerns.</i>					
	BPO9	9	34 1/2	24	◆ (1) DR0930	(1) Door Top and Bottom Spice Racks are "Fixed" Middle Spice Rack is Adjustable
	BPO12	12	34 1/2	24	◆ (1) DR1230	End Panels are flush on both sides
	BPO15	15	34 1/2	24	◆ (1) DR1530	Uses Door to Match Selected Door Style
	BPO18	18	34 1/2	24	◆ (1) DR1830	Soft Close Glides Not Available

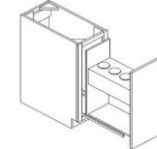
	Width	Height	Depth	Cabinet Door and Drawer Head	Full Access Construction	
Base Pull Out with Canisters						
<i>Available in Carriage House Series Only</i>						
	BPOC9	9	34 1/2	24	◆ (1) DR0930	(1) Door
	BPOC12	12	34 1/2	24	◆ (1) DR1230	(1) Fixed top shelf with (4) metal canisters (1) fixed bottom shelf End Panels flush on both sides <i>*Soft close not available</i>

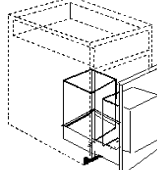
	Width	Height	Depth	Cabinet Door and Drawer Head	Frame Construction	
Base Trash Cabinet						
	BTC15	15	34 1/2	24	◆ (1) DR1524 (1) DH1506	(1) 35 Qt Bin
	BTC18	18	34 1/2	24	◆ (1) DR1824 (1) DH1806	(2) 35 Qt Bins
	BTC21	21	34 1/2	24	◆ (1) DR2124 (1) DH2106	(2) 35 Qt Bins (1) Standard Drawer Wood Framed Pullout Trash Unit End Panels are flush on both sides Soft Close Glides Not Available on Trash Unit Pullout

Base Cabinetry

Base Cabinets

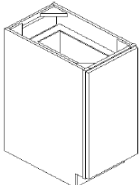
	Width	Height	Depth	Cabinet Door and Drawer Head		Frame Construction
Base Trash Cabinet Full Height						
	BTCFH15	15	34 1/2	24	◆ (1) DR1530	(1) 50 Qt Bin
	BTCFH18	18	34 1/2	24	◆ (1) DR1830	(2) 50 Qt Bins
	BTCFH21	21	34 1/2	24	◆ (1) DR2130	(2) 50 Qt Bins
						Wood Framed Pullout Trash Unit End Panels are flush on both sides No Soft Close Glides

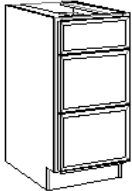
Base Drawer					Frame Construction	
	BD12	12	34 1/2	24	◆ (1) DH1206 (2) DH1211	(1) Standard Upper Drawer
	BD15	15	34 1/2	24	◆ (1) DH1506 (2) DH1511	(2) Deep Lower Drawers
	BD18	18	34 1/2	24	◆ (1) DH1806 (2) DH1811	75lb Glide Capacity Including Drawer
	BD21	21	34 1/2	24	◆ (1) DH2106 (2) DH2111	
	BD24	24	34 1/2	24	◆ (1) DH2406 (2) DH2411	
	BD27	27	34 1/2	24	◆ (1) DH2706 (2) DH2711	
	BD30	30	34 1/2	24	◆ (1) DH3006 (2) DH3011	
	BD33	33	34 1/2	24	◆ (1) DH3306 (2) DH3311	
	BD36	36	34 1/2	24	◆ (1) DH3606 (2) DH3611	

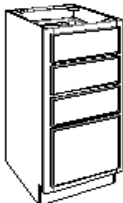
Base 4 Drawer					Frame Construction	
	B4D12	12	34 1/2	24	◆ (3) DH1206 (1) DH1209	(3) Standard Upper Drawers
	B4D15	15	34 1/2	24	◆ (3) DH1506 (1) DH1509	(1) Deep Bottom Drawer
	B4D18	18	34 1/2	24	◆ (3) DH1806 (1) DH1809	75lb Glide Capacity Including Drawer
	B4D21	21	34 1/2	24	◆ (3) DH2106 (1) DH2109	
	B4D24	24	34 1/2	24	◆ (3) DH2406 (1) DH2409	
<i>*All 5 piece drawer fronts have recessed center panel</i>						

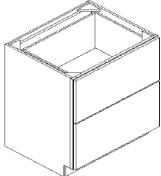
Base Deep Drawer					Frame Construction	
	BDD24	24	34 1/2	24	◆ (2) DH2415	Drawer Heads are 5-Piece Construction
	BDD27	27	34 1/2	24	◆ (2) DH2715	Drawer Depth is 20"
	BDD30	30	34 1/2	24	◆ (2) DH3015	End Panels are flush on both sides
	BDD33	33	34 1/2	24	◆ (2) DH3315	100lb Glide Capacity Including Drawer
	BDD36	36	34 1/2	24	◆ (2) DH3615	

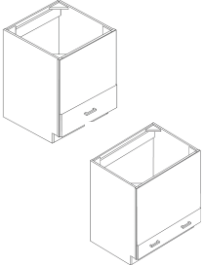
Base Microwave Cabinet					Frame Construction	
	BMW24-11	24	34 1/2	24	◆ (1) DH2411 Framed Opening 21 3/4 x 15 3/4"	Interior Opening is Unfinished
	BMW27-09	27	34 1/2	24	◆ (1) DH2709 Framed Opening 24 3/4 x 17 3/4"	OTKF Overlay Panel Standard
	BMW30-09	30	34 1/2	24	◆ (1) DH3009 Framed Opening 27 3/4 x 17 3/4"	Note: Flush Exteriors, Not Finished Exteriors
	BMW33-06	33	34 1/2	24	◆ (1) DH3306 Framed Opening 30 3/4 x 20 3/4"	(You still have to call out VL/VR/VV for these cabinets)
					Overlay Panels:	
					BMW24: 23 15/16" Wide	
					BMW27: 26 15/16" Wide	
					BMW30: 29 15/16" Wide	
					BMW33: 32 15/16" Wide	

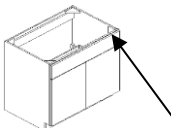
Cooktop Base					Frame Construction	
	CTB30	30	34 1/2	24	◆ (2) DR1524 (1) DH3006	Drawerhead is false front only
	CTB36	36	34 1/2	24	◆ (2) DR1824 (1) DH3606	(2) Pullout Trays (2) Half Shelves (GHS)
Has no drawer core						

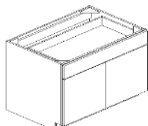

Base Cooktop					Frame Construction	
	BCT30	30	34 1/2	24	◆ (2) DR1524 (1) DH3006	Vanity depth drawer to allow for mechanicals
	BCT36	36	34 1/2	24	◆ (2) DR1824 (1) DH3306	Drawer Depth is 18"

Base Cabinetry

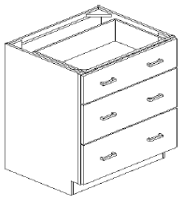
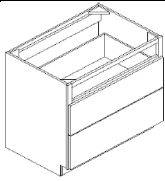
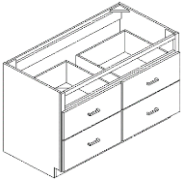
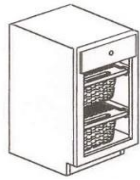
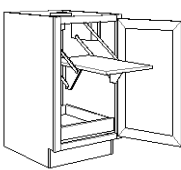
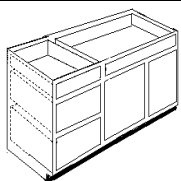
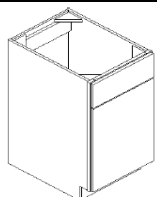
Base Cabinets

	Width	Height	Depth	Cabinet Door and Drawer Head		
Base Drawer Cooktop						
	BDCT30	30	34 1/2	24	◆ (1) DH3006 (2) DH3011	Vanity depth drawer to allow for mechanicals Drawer Depth is 18"
	BDCT36	36	34 1/2	24	◆ (1) DH3606 (2) DH3611	
Base Drawer Range Top						
	BDRT30	30	34 1/2	24	◆ (2) DH3011	Same as BD30 but without top drawer Same as BD36 but without top drawer 75lb Glide Capacity Including Drawer
	BDRT36	36	34 1/2	24	◆ (2) DH3611	
<div style="border: 1px solid black; padding: 5px; display: inline-block;"> Installation Note: Must remove top rail. This rail can be used for smaller height range top. </div>						
	BDRT48	48	34 1/2	24	◆ (4) DH2411	75lb Glide Capacity Including Drawer
Base Basket						
	<i>Available in Carriage House Series Only</i>				Frame Construction	
	BBAS18	18	34 1/2	24	◆ (1) DH0506	(1) Standard Drawer (2) Open Baskets End Panels Finished on Interior End panels flush on both sides
Base Mixer Cabinet						
	<i>Available in Carriage House Series Only</i>				Frame Construction	
	BMX18 L/R	18	34 1/2	24	◆ (1) DR1830	(1) 15' wide 3" high pullout tray on bottom End Panels are constructed by 5/8" thick plywood to support the lift assembly and weight of the mixer
Base Drawer (Combo)						
	<i>Available in Carriage House Series Only</i>				Frame Construction	
	BD45 L/R	45	34 1/2	24	◆ (2) DR1524 (1) DH3006 (1) DH1506 (2) DH1511	(2) Doors (2) Standard Drawers
	BD48 L/R	48	34 1/2	24	◆ (2) DR1624 (1) DH3306 (1) DH1506 (2) DH1511	(2) Deep Lower Drawers
	BD54 L/R	54	34 1/2	24	◆ (2) DR1824 (1) DH3606 (1) DH1806 (2) DH1811	(1) Pullout (1) Half Shelf (GHS) behind Doors (1) Middle Roll Out (CHS) behind Doors
* image shown as left						
Sink Base (Single Door)						
	<i>Available in Carriage House Series Only</i>				Frame Construction	
	SB18 L/R	18	34 1/2	24	◆ (1) DR1824 (1) DH1806	(1) False Drawer Head (1) Door
	SB21 L/R	21	34 1/2	24	◆ (1) DR2124 (1) DH2106	(1) Fill Stick

Base Cabinetry

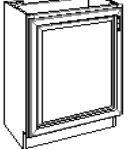
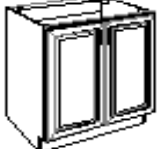
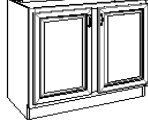
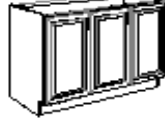
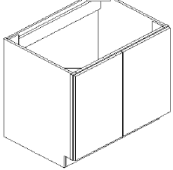
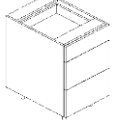
Base Cabinets		Width	Height	Depth	Cabinet Door and Drawer Head	Frame Construction
Sink Base (Double Door)						
	SB24	24	34 1/2	24	◆ (2) DR1224 (1) DH2406	(1) False Drawer Head (2) Doors (1) Fill Stick
	SB27	27	34 1/2	24	◆ (2) DR1324 (1) DH2706	
	SB30	30	34 1/2	24	◆ (2) DR1524 (1) DH3006	
	SB33	33	34 1/2	24	◆ (2) DR1624 (1) DH3306	
	SB36	36	34 1/2	24	◆ (2) DR1824 (1) DH3606	
	SB39	39	34 1/2	24	◆ (2) DR1924 (1) DH3906	
	SB42	42	34 1/2	24	◆ (2) DR2124 (2) DH2106	(2) False Drawer Heads (2) Doors 2 1/4" Center Stile (1) Fill Stick
	SB48	48	34 1/2	24	◆ (2) DR1524 (1) DR1824 (2) DH1506 (1) DH1806 <i>** DR1824 is the size of the middle door</i>	(3) False Drawer Heads (3) Doors 2 1/4" Center Stile (1) Fill Stick
Sink Base Full Height (Single Door)						
	SBFH18 L/R	18	34 1/2	24	◆ (1) DR1830	(1) Full Height Door (1) Fill Stick
	SBFH21 L/R	21	34 1/2	24	◆ (1) DR2130	
Sink Base Full Height (Double Door)						
	SBFH24	27	34 1/2	24	◆ (2) DR1230	(2) Full Height Doors (1) Fill Stick
	SBFH27	27	34 1/2	24	◆ (2) DR1330	
	SBFH30	30	34 1/2	24	◆ (2) DR1530	
	SBFH33	33	34 1/2	24	◆ (2) DR1630	
	SBFH36	36	34 1/2	24	◆ (2) DR1830	
	SBFH39	39	34 1/2	24	◆ (2) DR1930	
	SBFH42	42	34 1/2	24	◆ (2) DR2130	(2) Full Height Doors (1) Fill Stick
	Sink Base Full Height (Triple Door)					
	SBFH48	48	34 1/2	24	◆ (2) DR1530 (1) DR1830	(3) Full Height Doors 2 1/4" Center Stile (1) Fill Stick
	Sink Base Full Height Removable Front - ADA					
	SBFH33-ADA 33	32 1/2	24	◆ (2) DR1628.5	Face frame removable Removable Floor ADA adaptable L/R panels remain	
	SBFH36-ADA 36	32 1/2	24	◆ (2) DR1828.5		
*N/A IN RAISED PANEL DOOR STYLES						
Base Drawer - ADA						
	BD12-ADA	12	32 1/2	24	◆ (1) DH1206 (1) DH1209 (1) DH1211	Frame Construction
	BD15-ADA	15	32 1/2	24	◆ (1) DH1506 (1) DH1509 (1) DH1511	
	BD18-ADA	18	32 1/2	24	◆ (1) DH1806 (1) DH1809 (1) DH1811	
	BD21-ADA	21	32 1/2	24	◆ (1) DH2106 (1) DH2109 (1) DH2111	

Base Cabinetry

Base Cabinets

Sink Base Farm Sink (Double Door) Frame Construction

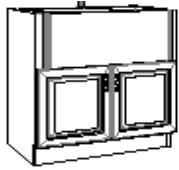

	Width	Height	Depth	Cabinet Door and Drawer Head
SBFS30	30	34 1/2	24	◆ (2) DR1518
SBFS33	33	34 1/2	24	◆ (2) DR1618
SBFS36	36	34 1/2	24	◆ (2) DR1818

Full Overlay Panel 12 3/8" High
No Shelf or Pullout
(1) Fill Stick

Top Panel is full overlay which can be used for:
(1) Cut-out for farm sink
(2) Cut-out for Wolf or Viking Range Tops

Farm Sink Front Frame Construction

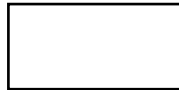

FSF30	30	12 3/8	3/4
FSF33	33	12 3/8	3/4
FSF36	36	12 3/8	3/4

Sink Base "Base" Combo Frame Construction



SBB45 L/R	45	34 1/2	24	◆ (3) DR1524 (1) DH3006 (1) DH1506
SBB48 L/R	48	34 1/2	24	◆ (2) DR1624 (1) DR1524 (1) DH3306 (1) DH1506
SBB54 L/R	54	34 1/2	24	◆ (3) DR1824 (1) DH3606 (1) DH1806

Large Drawerhead is False Front Only
(1) Drawer and (1) Pullout Tray on "Base Side"
L/R designates position of smaller cabinet and 2 1/4" stile placement
GHS has (1) Shelf on "Base Side"
(1) Fill Stick

Has no drawer core pullout on sink base side

*image shown as left

Sink Base Drawer (Combo) Frame Construction

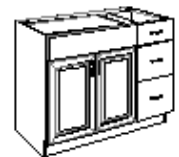

SBD45 L/R	45	34 1/2	24	◆ (2) DR1524 (1) DH3006 (1) DH1506 (2) DH1511
SBD48 L/R	48	34 1/2	24	◆ (2) DR1624 (1) DH3306 (1) DH1506 (2) DH1511
SBD54 L/R	54	34 1/2	24	◆ (2) DR1824 (1) DH3606 (1) DH1806 (2) DH1811

(2) Doors
(1) Standard Drawer
(2) Deep Drawers
2 1/4" Center Stile
L/R designates position of drawer base
75 lb Glide Capacity Including Drawer
(1) Fill Stick

*image shown as right

Sink Base Drawer Full Height (Combo) Frame Construction

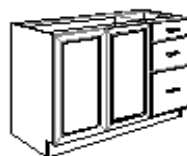

SBDFH45 L/R	45	34 1/2	24	◆ (2) DR1530 (1) DH1506 (2) DH1511
SBDFH48 L/R	48	34 1/2	24	◆ (2) DR1630 (1) DH1506 (2) DH1511
SBDFH54 L/R	54	34 1/2	24	◆ (2) DR1830 (1) DH1806 (2) DH1811

(2) Full Height Doors (30")
(1) Standard Drawer
(2) Deep Drawers
2 1/4" Center Stile
L/R designates position of drawer base
75 lb Glide Capacity Including Drawer
(1) Fill Stick

*image shown as right

Sink Base Trash Cabinet (Combo) Frame Construction

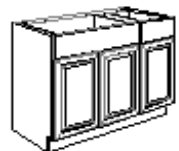

SBTC45 L/R	45	34 1/2	24	◆ (3) DR1524 (1) DH3006 (1) DH1506
SBTC48 L/R	48	34 1/2	24	◆ (2) DR1624 (1) DR1524 (1) DH3306 (1) DH1506
SBTC54 L/R	54	34 1/2	24	◆ (3) DR1824 (1) DH3606 (1) DH1806

(1) Standard Drawer
Pullout Trash Unit
Wood Framed Pullout
35 Qt Containers
L/R designates position of trash unit
End Panel is flush on trash unit side
Soft Close Glides Not Available on Trash Unit Pullout
(1) Fill Stick

*image shown as right

**SBTC45 & SBTC48 have a single trash can unit (1) 35 Qt Bin
**SBTC54 has a double trash can unit (2) 35 Qt Bins

Sink Base Trash Cabinet Full Height (Combo) Frame Construction

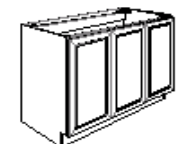

SBTCFH45 L/R	45	34 1/2	24	◆ (3) DR1530
SBTCFH48 L/R	48	34 1/2	24	◆ (2) DR1630 (1) DR1530
SBTCFH54 L/R	54	34 1/2	24	◆ (3) DR1830

Pullout Trash Unit
Wood Framed Pullout
50 Qt Containers
L/R designates position of trash unit
End Panel is flush on trash unit side
Soft Close Glides Not Available on Trash Unit Pullout
(1) Fill Stick

*image shown as right

**SBTCFH45 & SBTCFH48 have a single trash can unit (1) 50 Qt Bin
**SBTCFH54 has a double trash can unit (2) 50 Qt Bins

Base Cabinetry

Base Cabinets

Base Blind Corner Frame Construction

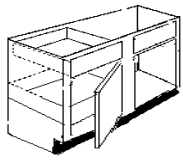

Model	Width	Height	Depth	Hardware
BBC39/42 L/R	30	34 1/2	24	◆ (1) DR1224 (1) DH1206
BBC42/45 L/R	36	34 1/2	24	◆ (1) DR1524 (1) DH1506
BBC45/48 L/R	42	34 1/2	24	◆ (1) DR1824 (1) DH1806
BBC48/51 L/R	48	34 1/2	24	◆ (1) DR2124 (1) DH2106

*image shown as right

- (1) Door
- (1) Drawer
- (1) Pullout (GHS has 1/2 shelf)
- 3" Cover Overlay Filler included
- 6" Cover Overlay Filler Attached
- Closure Panel for Blind Attached
- L/R designates position of blind side

Carriage House Series Cabinet	Cabinet Width	Door Width	Minimum Pull	Maximum Pull
BBC39/42 L/R	30"	12"	39"	42"
BBC42/45 L/R	36"	15"	42"	45"
BBC45/48 L/R	42"	18"	45"	48"
BBC48/51 L/R	48"	21"	48"	51"

Gatehouse Series/CHS Value Series Cabinet	Cabinet Width	Door Width	Minimum Pull	Maximum Pull
BBC39/42 L/R	27"	12"	39"	42"
BBC42/45 L/R	30"	15"	42"	45"
BBC45/48 L/R	33"	18"	45"	48"
BBC48/51 L/R	36"	21"	48"	51"

Base Blind Corner Full Height Frame Construction

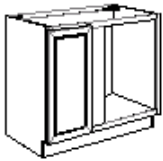

Model	Width	Height	Depth	Hardware
BBCFH39/42 L/R	30	34 1/2	24	◆ (1) DR1230
BBCFH42/45 L/R	36	34 1/2	24	◆ (1) DR1530
BBCFH45/48 L/R	42	34 1/2	24	◆ (1) DR1830
BBCFH48/51 L/R	48	34 1/2	24	◆ (1) DR2130

*image shown as right

- (1) Full Height Door (30")
- (1) Pullout (GHS has 1/2 shelf)
- 3" Corner Overlay Filler INCLUDED
- 6" Cover Overlay Filler Attached
- Closure Panel for Blind Attached
- L/R designates position of blind side

Carriage House Series Cabinet	Cabinet Width	Door Width	Minimum Pull	Maximum Pull
BBCFH39/42 L/R	30"	12"	39"	42"
BBCFH42/45 L/R	36"	15"	42"	45"
BBCFH45/48 L/R	42"	18"	45"	48"
BBCFH48/51 L/R	48"	21"	48"	51"

Gatehouse Series/CHS Value Series Cabinet	Cabinet Width	Door Width	Minimum Pull	Maximum Pull
BBCFH39/42 L/R	27"	12"	39"	42"
BBCFH42/45 L/R	30"	15"	42"	45"
BBCFH45/48 L/R	33"	18"	45"	48"
BBCFH48/51 L/R	36"	21"	48"	51"

Base Blind Corner Swing-Out Frame Construction

Available in Carriage House Series Only

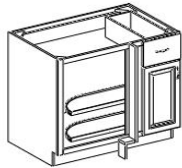

Model	Width	Height	Depth	Hardware
BBCSO45/48 L/R	42	34 1/2	24	◆ (1) DR1824 (1) DH1806
BBCSO48/51 L/R	48	34 1/2	24	◆ (1) DR2124 (1) DH2106

Swing out does not work if adjacent appliance is deeper than 25"

*image shown as left

- (1) Door
- (1) Drawer
- (2) Swing-Out Shelves
- 3" Corner Overlay Filler INCLUDED
- 6" Cover Overlay Filler Attached
- 2 1/4" Center Stile
- Closure Panel for Blind Attached
- L/R designates position of blind side

Base Blind Corner Full Height Swing-Out Frame Construction

Available in Carriage House Series Only

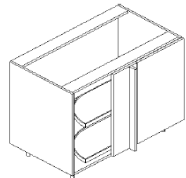

Model	Width	Height	Depth	Hardware
BBCFHSO4548 L/R	42	34 1/2	24	◆ (1) DR1830
BBCFHSO4851 L/R	48	34 1/2	24	◆ (1) DR2130

Swing out does not work if adjacent appliance is deeper than 25"

*image shown as left

- (1) Door
- (2) Swing-Out Shelves
- 3" Corner Overlay Filler INCLUDED
- 6" Cover Overlay Filler Attached
- 2 1/4" Center Stile
- Closure Panel for Blind Attached
- L/R designates position of blind side

Base Corner Shelf Full Access Construction

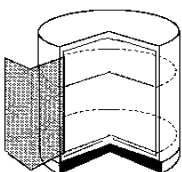

Model	Width	Height	Depth	Hardware
BCS33 L/R	33	34 1/2	33	◆ (1) DR0830 (Use Code CD-Cab to Door) (1) DR0830 (Use Code DD-Door to Door)
BCS36 L/R	36	34 1/2	36	◆ (1) DR1130 (Use Code CD-Cab to Door) (1) DR1130 (Use Code DD-Door to Door)

- (1) Fixed Shelf
- Requires 33" in Each Direction

- (1) Fixed Shelf
- Requires 36" in Each Direction

Base Lazy Susan Full Access Construction

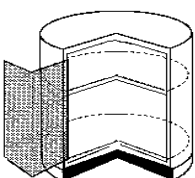





Model	Width	Height	Depth	Hardware
BLS33 L/R	33	34 1/2	33	◆ (1) DR0830 (Use Code CD-Cab to Door) (1) DR0830 (Use Code DD-Door to Door)
BLS36 L/R	36	34 1/2	36	◆ (1) DR1130 (Use Code CD-Cab to Door) (1) DR1130 (Use Code DD-Door to Door)

- (2) Wood Pie Cut Shelves that Rotate Independently
- Requires 33" in Each Direction

- (2) Wood Pie Cut Shelves that Rotate Independently
- Requires 36" in Each Direction

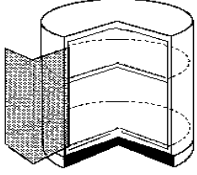

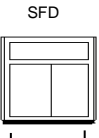
Base Cabinetry

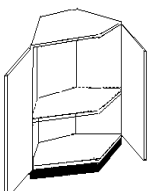
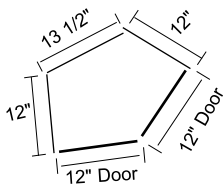
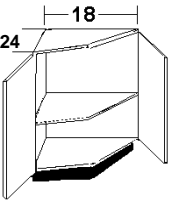
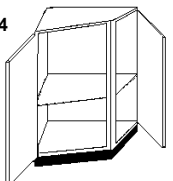
Base Cabinets

		Width	Height	Depth	Cabinet Door and Drawer Head	
Base Lazy Susan with Upgraded Tray		<i>Available in Carriage House Series Only</i>			Full Access Construction	
	BLSU36L/R	36	34 1/2	33	◆ (1) DR1130 (Use Code CD-Cab to Door) ◆ (1) DR1130 (Use Code DD-Door to Door)	(2) Wood Pie Cut Shelves that Rotate Independently Requires 36" in Each Direction <i>Wood pie cut shelves have thick wood edge and heavy duty ball-bearing spinning trays</i>
Sink Front Diagonal					Frame Construction	
	SFD36 L/R	17	34 1/2	3/4	◆ (1) DR1524 (1) DH1506	Requires 36" of space in each direction
	SFD42	24	34 1/2	3/4	◆ (2) DR1224 (1) DH2406	Requires 42" of space in each direction
	SFD-FLOOR36	36	36	3/4	◆ Sink Floor 36x36	Needs to be cut in field*
	SFD-FLOOR42	42	42	3/4	◆ Sink Floor 42x42	Needs to be cut in field*
17"	25.4"					
Sink Front Diagonal Full Height					Frame Construction	
	SDFH36 L/R	17	34 1/2	3/4	◆ (1) DR1530	Requires 36" of space in each direction
	SDFH42	24	34 1/2	3/4	◆ (2) DR1230	Requires 42" of space in each direction
17"	25.45"					
SDFH36 L/R	SDFH42					
Base Chrysler					Full Access Construction	
	BC45	*	34 1/2	*	◆ (2) DR1230	(1) Fixed Shelf Toe Kick Attached Cannot Finish Ends
		* See Drawing for Dimensions *Used for an outside 45 degree turn in a peninsula or island				
Base Corner					Full Access Construction	
	BC1824 L/R	18	34 1/2	24	◆ (2) DR1630	(1) Fixed Shelf Toe Kick Shipped Unattached Cannot finish ends L/R designates the 90 degree side
24"	18"					
	BC2424 L/R	24	34 1/2	24	◆ (2) DR1830	(1) Fixed Shelf Center Post Toe Kick Shipped Unattached Cannot Finish Ends L/R designates the 90 degree side
24"	24"					

Base Cabinetry

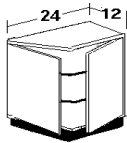
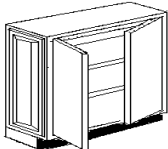
Base Cabinets

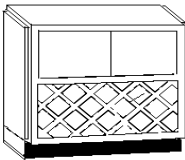
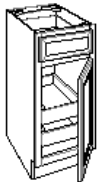
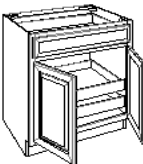
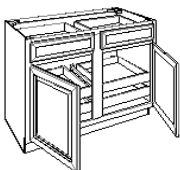
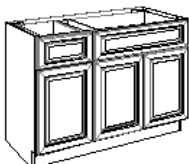
	Width	Height	Depth	Cabinet Door and Drawer Head	
Base End Corner					Full Access Construction
	BEC24 L/R	24	34 1/2	12	◆ (2) DR1530
	*image shown as right				(2) Fixed Shelves Toe Kick Shipped Unattached Cannot Finish Ends L/R designates the 90
Base End Unit (Double Door)					Frame Construction
	BEU24	25 1/2	34 1/2	12	◆ (2) DR1230 (2) DR1230 - "Side Panels"
	BEU36	37 1/2	34 1/2	12	◆ (2) DR1830 (2) DR1230 - "Side Panels"
	* Side panels can be removed in field *				(2) Adjustable Shelves (2) DR1230 (Door Panels) Attached to Cabinet Sides Used at the end of a peninsula or island
Base End Unit Open Shelf					Frame Construction
	BEUOS24	25 1/2	34 1/2	12	◆ (2) DR1230 - "Side Panels"
	BEUOS36	37 1/2	34 1/2	12	◆ (2) DR1230 - "Side Panels"
	* Side panels can be removed in field *				(1) Adjustable Shelf (2) DR1230 (Door Panels) Attached to Cabinet Sides Used at the end of a peninsula or island Finished Interior
Base End Unit Wine Rack (Double Door)					Frame Construction
	BEUWR36	37 1/2	34 1/2	12	◆ (2) DR1812 (2) DR1230 - "Side Panels"
	* Side panels can be removed in field *				(2) DR1230 (Door Panels) Attached to Cabinet Sides Used at the end of a peninsula or island Finished Interior Holds 17 bottles
Base with 2 Pullout Trays (Single Door)					Frame Construction
	B12L-2T/B12R-2T	12	34 1/2	24	◆ (1) DR1224 (1) DH1206
	B15L-2T/B15R-2T	15	34 1/2	24	◆ (1) DR1524 (1) DH1506
	B18L-2T/B18R-2T	18	34 1/2	24	◆ (1) DR1824 (1) DH1806
	B21L-2T/B21R-2T	21	34 1/2	24	◆ (1) DR2124 (1) DH2106
					(1) Drawer (1) Pullout Tray Middle Position (1) 1 1/2" High Pullout Tray on Bottom
Base with 2 Pullout Trays (Double Door)					Frame Construction
	B24-2T	24	34 1/2	24	◆ (2) DR1224 (1) DH2406
	B27-2T	27	34 1/2	24	◆ (2) DR1324 (1) DH2706
	B30-2T	30	34 1/2	24	◆ (2) DR1524 (1) DH3006
	B33-2T	33	34 1/2	24	◆ (2) DR1624 (1) DH3306
	B36-2T	36	34 1/2	24	◆ (2) DR1824 (1) DH3606
	B42-2T	42	34 1/2	24	◆ (2) DR2124 (2) DH2106
					(2) Drawers (2) Pullout Trays Middle Position (2) 1 1/2" High Pullout Trays on Bottom 2 14" Center Stile
Base with 2 Pullout Trays (Triple Door)					Frame Construction
	B39L-2T/B39R-2T	39	34 1/2	24	◆ (1) DR1224 (2) DR1324 (1) DH1206 (1) DH2706
	B45L-2T/B45R-2T	45	34 1/2	24	◆ (3) DR1524 (1) DH3006 (1) DH1506
	B48L-2T/B48R-2T	48	34 1/2	24	◆ (2) DR1624 (1) DR1524 (1) DH3306 (1) DH1506
	B54L-2T/B54R-2T	54	34 1/2	24	◆ (3) DR1824 (1) DH3606 (1) DH1806
	*image shown as left				(2) Drawers (2) Pullout Trays Middle Position (2) 1 1/2" High Pullout Trays on Bottom L/R designates position of single door and 2 1/4" stile placement

Base Cabinetry

Base Cabinets

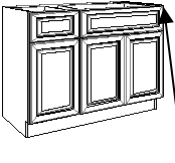
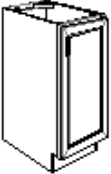
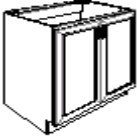
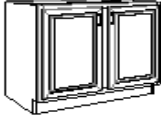
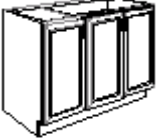
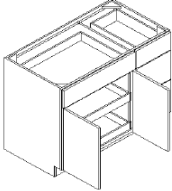
	Width	Height	Depth	Cabinet Door and Drawer Head	Frame Construction	
Cooktop Base with 2 Pullout Trays						
 <p>*image shown as left</p> <p>Has no drawer core</p>	CTB30-2T	30	34 1/2	24	◆ (2) DR1524 (1) DH3006	Large drawerhead is false front only (2) Pullout Trays Middle Position (2) 1 1/2" High Pullout Trays On Bottom L/R designates position of single door and 2 1/4" stile placement
	CTB36-2T	36	34 1/2	24	◆ (2) DR1824 (1) DH3606	
Base Full Height with 2 Pullout Trays (Single Door)						
	BFH12L-2T/BFH12R-2T	12	34 1/2	24	◆ (1) DR1230	(1) Pullout Tray Middle Position
	BFH15L-2T/BFH15R-2T	15	34 1/2	24	◆ (1) DR1530	(1) 1 1/2" High Pullout Tray on Bottom
	BFH18L-2T/BFH18R-2T	18	34 1/2	24	◆ (1) DR1830	
	BFH21L-2T/BFH21R-2T	21	34 1/2	24	◆ (1) DR2130	
Base Full Height with 2 Pullout Trays (Double Door)						
	BFH24-2T	24	34 1/2	24	◆ (2) DR1230	(1) Pullout Tray Middle Position
	BFH27-2T	27	34 1/2	24	◆ (2) DR1330	(1) 1 1/2" High Pullout Tray on Bottom
	BFH30-2T	30	34 1/2	24	◆ (2) DR1530	
	BFH33-2T	33	34 1/2	24	◆ (2) DR1630	
	BFH36-2T	36	34 1/2	24	◆ (2) DR1830	
	BFH42-2T	42	34 1/2	24	◆ (2) DR2130	(2) Pullout Trays Middle Position (2) 1 1/2" High Pullout Trays on Bottom 2 1/4" Center Stile
Base Full Height with 2 Pullout Trays (Triple Door)						
 <p>*image shown as right</p>	BFH39L-2T/BFH39R-2T	39	34 1/2	24	◆ (1) DR1230 (2) DR1330	(2) Pullout Trays Middle Position
	BFH45L-2T/BFH45R-2T	45	34 1/2	24	◆ (3) DR1530	(2) 1 1/2" High Pullout Trays on Bottom
	BFH48L-2T/BFH48R-2T	48	34 1/2	24	◆ (2) DR1630 (1) DR1530	L/R designates position of single door and 2 1/4" stile placement
	BFH54L-2T/BFH54R-2T	54	34 1/2	24	◆ (3) DR1830	
Base Drawer with 2 Pullout Trays (Combo)						
 <p>*image shown as right</p>	BD45L-2T/BD45R-2T	45	34 1/2	24	◆ (2) DR1524 (1) DH3006 (1) DH1506 (1) DH1511	(2) Doors
	BD48L-2T/BD48R-2T	48	34 1/2	24	◆ (2) DR1624 (1) DH3306 (1) DH1506 (2) DH1511	(2) Standard Drawers
	BD54L-2T/BD54R-2T	54	34 1/2	24	◆ (2) DR1824 (1) DH3606 (1) DH1806 (2) DH1811	(2) Deep Lower Drawers
						(1) Pullout Tray Middle Position (1) 1 1/2" High Pullout Tray on Bottom L/R designates position of drawer base 75 lb Glide Capacity Including Drawer

Base Cabinetry

Base Cabinets

Width Height Depth Cabinet Door and Drawer Head

Base Blind Corner Full Height with 2 Pullout Trays

Frame Construction

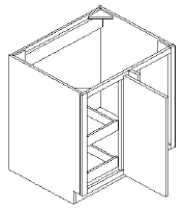

BBCFH39L-2T/BBCFH39R-2T	30	34 1/2	24	◆ (1) DR1230
BBCFH42L-2T/BBCFH42R-2T	36	34 1/2	24	◆ (1) DR1530
BBCFH45L-2T/BBCFH45R-2T	42	34 1/2	24	◆ (1) DR1830
BBCFH48L-2T/BBCFH48R-2T	48	34 1/2	24	◆ (1) DR2130

*image shown as right

(1) Full Height Door (30")
 (1) Pullout Tray Middle Position
 (1) 1 1/2" High Pullout Tray on Bottom
 3" Corner Overlay Filler INCLUDED
 6" Cover Overlay Filler ATTACHED
 2 1/4" Center Stile Closure Panel for Blind Attached
 L/R designates position of blind side

Carriage House Series Cabinet	Cabinet Width	Door Width	Minimum Pull	Maximum Pull
BBC39/42L/R-2T	30"	12"	39"	42"
BBC42/45L/R-2T	36"	15"	42"	45"
BBC45/48L/R-2T	42"	18"	45"	48"
BBC48/51L/R-2T	48"	21"	48"	51"

Gatehouse Series/CHS Value Series Cabinet	Cabinet Width	Door Width	Minimum Pull	Maximum Pull
BBC39/42L/R-2T	27"	12"	39"	42"
BBC42/45L/R-2T	30"	15"	42"	45"
BBC45/48L/R-2T	33"	18"	45"	48"
BBC48/51L/R-2T	36"	21"	48"	51"

Base - Depth: 21"

Available in Carriage House Series Only

Frame Construction

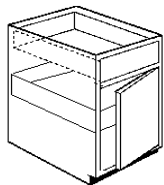

B12-21 L/R	12	34 1/2	21	◆ (1) DR1224 (1) DH1206
B15-21 L/R	15	34 1/2	21	◆ (1) DR1524 (1) DH1506
B18-21 L/R	18	34 1/2	21	◆ (1) DR1824 (1) DH1806
B21-21 L/R	21	34 1/2	21	◆ (1) DR2124 (1) DH2106

(1) Drawer
 (1) Pullout Tray (CHS)
 Not Offered in Gatehouse

B24-21	24	34 1/2	21	◆ (2) DR1224 (1) DH2406
--------	----	--------	----	-------------------------

(2) Doors

Base Full Height - Depth: 21"

Available in Carriage House Series Only

Frame Construction

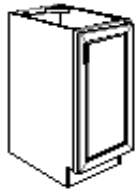

BFH12-21 L/R	12	34 1/2	21	◆ (1) DR1230
BFH15-21 L/R	15	34 1/2	21	◆ (1) DR1530
BFH18-21 L/R	18	34 1/2	21	◆ (1) DR1830
BFH21-21 L/R	21	34 1/2	21	◆ (1) DR2130

(1) Pullout Tray (CHS)
 Not Offered in Gatehouse

BFH24-21	24	34 1/2	21	◆ (2) DR1230
----------	----	--------	----	--------------

(2) Doors

BFH30-21	30	34 1/2	21	◆ (2) DR1530
----------	----	--------	----	--------------

BFH36-21	36	34 1/2	21	◆ (2) DR1830
----------	----	--------	----	--------------

Base with 2 Pullout Trays - Depth: 21"

Available in Carriage House Series Only

Frame Construction

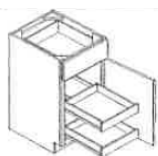

B12-21 L/R-2T	12	34 1/2	21	◆ (1) DR1224 (1) DH1206
B15-21 L/R-2T	15	34 1/2	21	◆ (1) DR1524 (1) DH1506
B18-21 L/R-2T	18	34 1/2	21	◆ (1) DR1824 (1) DH1806
B21-21 L/R-2T	21	34 1/2	21	◆ (1) DR2124 (1) DH2106

(1) Drawer
 (2) Pullout Trays (CHS)
 Not Offered in Gatehouse

B24-21-2T	24	34 1/2	21	◆ (2) DR1224 (1) DH2406
-----------	----	--------	----	-------------------------

(1) Drawer
 (2) Doors

Base Full Height with 2 Pullout Trays - Depth: 21"

Available in Carriage House Series Only

Frame Construction

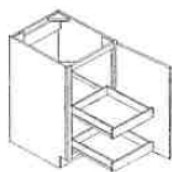

BFH12-21 L/R-2T	12	34 1/2	21	◆ (1) DR1230
BFH15-21 L/R-2T	15	34 1/2	21	◆ (1) DR1530
BFH18-21 L/R-2T	18	34 1/2	21	◆ (1) DR1830
BFH21-21 L/R-2T	21	34 1/2	21	◆ (1) DR2130

(2) Pullout Trays (CHS)
 Not Offered in Gatehouse

BFH24-21-2T	24	34 1/2	21	◆ (2) DR1230
-------------	----	--------	----	--------------

(2) Doors

Base Cabinetry

Base Cabinets

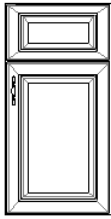
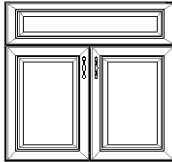
	Width	Height	Depth	Cabinet Door and Drawer Head	Frame Construction
Door Face Frame Base (Single Door)					Frame Construction
	DRFFBT6	6	30	3/4 ♦ (1) DR0630	No drawer head on DRFFBT6
	DRFFB12 L/R	12	30	3/4 ♦ (1) DR1224 (1) DH1206	Faceframe with hinged doors and false drawer front
	DRFFB15 L/R	15	30	3/4 ♦ (1) DR1524 (1) DH1506	
	DRFFB18 L/R	18	30	3/4 ♦ (1) DR1824 (1) DH1806	
	DRFFB21 L/R	21	30	3/4 ♦ (1) DR2124 (1) DH2106	
** DRFFBT6 Only Offered with Slab Door					
	DRFFB24	24	30	3/4 ♦ (2) DR1224 (1) DH2406	Faceframe with hinged doors and false drawer front
	DRFFB27	27	30	3/4 ♦ (2) DR1324 (1) DH2706	
	DRFFB30	30	30	3/4 ♦ (2) DR1524 (1) DH3006	
	DRFFB33	33	30	3/4 ♦ (2) DR1624 (1) DH3306	
	DRFFB36	36	30	3/4 ♦ (2) DR1824 (1) DH3606	
	DRFFB42	42	30	3/4 ♦ (2) DR2124 (2) DH2106	(2) Drawers

TAB: Tall Cabinetry

- *Index*
- *Construction Options & Modifications Key*
- *Cabinet Selection*

Tall Cabinetry

Page Location	Cabinet Type	Nomenclature
87	Construction Options & Modifications Key	
89	Oven Cabinet	OC
90	Oven Cabinet - Warming Drawer	OC-WDR
90	Oven Cabinet - Trim Kit Full	OC-TKF
91	Oven Trim Kit	OTK
89	Utility End Cabinets	UEC
88-89	Utility Cabinets	UC

Tall Cabinetry

Tall Cabinets

Finished Side Codes	
Description	Veneer Code
84" Tall	BV84
90" Tall	BV90
96" Tall	BV96
102" Tall	BV102

Cabinet Box Modification Codes	
BOX	Box with no doors or drawer heads
364	Box Only (No drawers/pullouts/doors/drawerheads/shelves/hinges)
PLY	Plywood Sides
AWB	All Wood Box
DTG	Dovetail Drawer/Full Access soft close glides *GATEHOUSE SERIES ONLY

Cabinet Component Modification Codes	
NTK	No Toekick Assembly
TTD	*Tall Tray Dividers **Offered on 96" and 102" Tall Cabinetry that is 24" Deep Only **Includes 3 Mounting rails and 1 Tray Divider. Order additional with code "Tray-Divider"

Drawer / Pullout Modification Codes	
FAP	Full Access Pullout **Available on 4T Utility Cabinet **This option is offered for Carriage House Series Only*

Door / Drawer Front Modification Codes	
SCH	Soft Close Door Hinges **This option is offered for Gatehouse Series Only*

Tall Cabinetry

Tall Cabinets

Utility Cabinets - Depth: 12" Full Access Construction

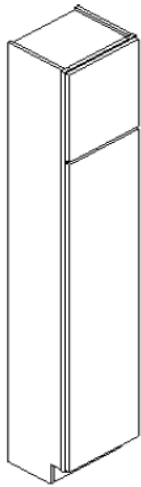

	Width	Height	Depth	Cabinet Door and Drawer Head	
UC1584 L/R	15	84	12	◆ (1) DR1518 (1) DR1561	No Shelf in Upper Section Pantry Shelf Kits (PSK) Sold Separately.
UC1884 L/R	18	84	12	◆ (1) DR1818 (1) DR1861	
UC2484	24	84	12	◆ (2) DR1218 (2) DR1261	
UC3084	30	84	12	◆ (2) DR1518 (2) DR1561	
UC1590 L/R	15	90	12	◆ (1) DR1524 (1) DR1561	(1) Adjustable Shelf in Upper Section Pantry Shelf Kits (PSK) Sold Separately. CHS has approximately 1 1/4" reveal between upper and lower doors
UC1890 L/R	18	90	12	◆ (1) DR1824 (1) DR1861	
UC2490	24	90	12	◆ (2) DR1224 (2) DR1261	
UC3090	30	90	12	◆ (2) DR1524 (2) DR1561	
UC1596 L/R	15	96	12	◆ (1) DR1530 (1) DR1561	(1) Adjustable Shelf in Upper Section Pantry Shelf Kits (PSK) Sold Separately.
UC1896 L/R	18	96	12	◆ (1) DR1830 (1) DR1861	
UC2496	24	96	12	◆ (2) DR1230 (2) DR1261	
UC3096	30	96	12	◆ (2) DR1530 (2) DR1561	
UC15102 L/R	15	102	12	◆ (1) DR1536 (1) DR1561	(2) Adjustable Shelf in Upper Section Pantry Shelf Kits (PSK) Sold Separately. Standard Plywood sides
UC18102 L/R	18	102	12	◆ (1) DR1836 (1) DR1861	Available in Carriage House Series only Not available in Gatehouse or Value Series
UC24102	24	102	12	◆ (2) DR1236 (2) DR1261	
UC30102	30	102	12	◆ (2) DR1536 (2) DR1561	

Loose Toekick

Utility Cabinets - Depth: 24" Full Access Construction

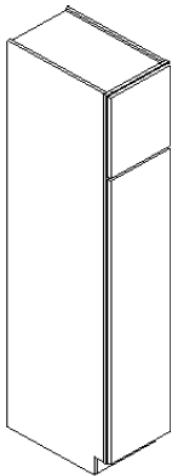

UC158424 L/R	15	84	24	◆ (1) DR1518 (1) DR1561	No Shelf in Upper Section (1) Structural Midshelf in Lower Section Full Depth Shelf Kits (PSK) Sold Separately. Pullout Trays (POT) Sold Separately.
UC188424 L/R	18	84	24	◆ (1) DR1818 (1) DR1861	
UC248424	24	84	24	◆ (2) DR1218 (2) DR1261	
UC308424	30	84	24	◆ (2) DR1518 (2) DR1561	
UC159024 L/R	15	90	24	◆ (1) DR1524 (1) DR1561	(1) Adjustable Shelf in Upper Section (1) Structural Midshelf in Lower Section Full Depth Shelf Kits (FDSK) Sold Separately. Pullout Trays (POT) Sold Separately. CHS has approximately 1 1/4" reveal between upper and lower doors
UC189024 L/R	18	90	24	◆ (1) DR1824 (1) DR1861	
UC249024	24	90	24	◆ (2) DR1224 (2) DR1261	
UC309024	30	90	24	◆ (2) DR1524 (2) DR1561	
UC159624 L/R	15	96	24	◆ (1) DR1530 (1) DR1561	(1) Adjustable Shelf in Upper Section (1) Structural Midshelf in Lower Section Full Depth Shelf Kits (FDSK) Sold Separately. Pullout Trays (POT) Sold Separately.
UC189624 L/R	18	96	24	◆ (1) DR1830 (1) DR1861	
UC249624	24	96	24	◆ (2) DR1230 (2) DR1261	
UC309624	30	96	24	◆ (2) DR1530 (2) DR1561	
UC1510224 L/R	15	102	24	◆ (1) DR1536 (1) DR1561	(1) Adjustable Shelf in Upper Section (1) Structural Midshelf in Lower Section Full Depth Shelf Kits (FDSK) Sold Separately. Pullout Trays (POT) Sold Separately. Available in Carriage House series only; Not available in Gatehouse or Value series
UC1810224 L/R	18	102	24	◆ (1) DR1836 (1) DR1861	
UC2410224	24	102	24	◆ (2) DR1236 (2) DR1261	
UC3010224	30	102	24	◆ (2) DR1536 (2) DR1561	

Loose Toekick

Utility Cabinets with 4 Pullout Trays Installed - Depth: 24" Full Access Construction

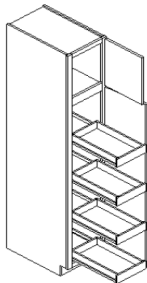

UC158424 L/R-4T	15	84	24	◆ (1) DR1518 (1) DR1561	No Shelf in Upper Section (1) Structural Midshelf in Lower Section Pantry Shelf Kits (PSK) Sold Separately. (4) Pullout Trays, factory-installed
UC188424 L/R-4T	18	84	24	◆ (1) DR1818 (1) DR1861	
UC248424-4T	24	84	24	◆ (2) DR1218 (2) DR1261	
UC308424-4T	30	84	24	◆ (2) DR1518 (2) DR1561	
UC159024 L/R-4T	15	90	24	◆ (1) DR1524 (1) DR1561	No Shelf in Upper Section (1) Structural Midshelf in Lower Section Pantry Shelf Kits (PSK) Sold Separately. (4) Pullout Trays (POT), factory-installed CHS has approximately 1 1/4" reveal between upper and lower doors
UC189024 L/R-4T	18	90	24	◆ (1) DR1824 (1) DR1861	
UC249024-4T	24	90	24	◆ (2) DR1224 (2) DR1261	
UC309024-4T	30	90	24	◆ (2) DR1524 (2) DR1561	

Loose Toekick

Tall Cabinetry

Tall Cabinets

Width Height Depth Cabinet Door and Drawer Head

Utility Cabinets with 4 Pullout Trays Installed - Depth: 24" (continued) Full Access Construction

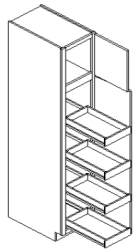

UC159624L/R-4T	15	96	24	◆ (1) DR1530 (1) DR1561	(1) Adjustable Shelf in Upper Section (1) Structural Midshelf in Lower Section (4) Pullout Trays (POT), factory installed
UC189624L/R-4T	18	96	24	◆ (1) DR1830 (1) DR1861	
UC249624-4T	24	96	24	◆ (2) DR1230 (2) DR1261	
UC309624-4T	30	96	24	◆ (2) DR1530 (2) DR1561	
UC1510224 L/R-4T	15	102	24	◆ (1) DR1536 (1) DR1561	(2) Adjustable Shelves in Upper Section (1) Structural Midshelf in Lower Section (4) Pullout Trays (POT), factory installed
UC1810224 L/R-4T	18	102	24	◆ (1) DR1836 (1) DR1861	Standard Plywood series Available in Carriage House series only
UC2410224-4T	24	102	24	◆ (2) DR1236 (2) DR1261	Not available in Gatehouse or Value series
UC3010224-4T	30	102	24	◆ (2) DR1536 (2) DR1561	

Loose Toekick

Utility End Cabinets Full Access Construction

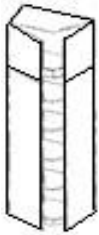

UEC84 L/R	24	84	12	◆ (2) DR1518 (2) DR1561	(4) Fixed Shelves
UEC90 L/R	24	90	12	◆ (2) DR1524 (2) DR1561	(4) Fixed Shelves; CHS has approximately 1/4" reveal between upper and lower doors
UEC96 L/R	24	96	12	◆ (2) DR1530 (2) DR1561	(6) Fixed Shelves Loose Toekick
UEC102 L/R	24	102	12	◆ (2) DR1536 (2) DR1561	(6) fixed shelves Standard Plywood sides Available in Carriage House Series only Not available in Gatehouse or Value Series

Loose Toekick

Finished Ends not available

Oven Cabinet (Single) Full Access Construction

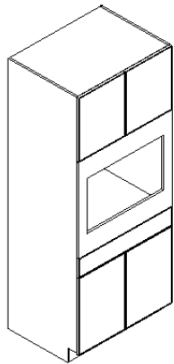

OC3084S	30	84	24	◆ (2) DR1518 (2) DR1524 (1) DH3006	No shelf in upper section
OC3384S	33	84	24	◆ (2) DR1618 (2) DR1624 (1) DH3306	
OC3090S	30	90	24	◆ (2) DR1524 (2) DR1524 (1) DH3006	(1) Adjustable shelf in upper section
OC3390S	33	90	24	◆ (2) DR1624 (2) DR1624 (1) DH3306	
OC3096S	30	96	24	◆ (2) DR1530 (2) DR1524 (1) DH3006	(1) Adjustable shelf in upper section
OC3396S	33	96	24	◆ (2) DR1630 (2) DR1624 (1) DH3306	
OC30102S	30	102	24	◆ (2) DR1536 (2) DR1524 (1) DH3006	(2) Adjustable shelves in upper section Standard Plywood sides
OC33102S	33	102	24	◆ (2) DR1636 (2) DR1624 (1) DH3306	Available in Carriage House Series only Not available in Gatehouse or Value Series

Loose Toekick

See page 91 for oven cabinet opening and trim size kits

GHS (1) 1/2-depth shelf in bottom section
CHS (1) Pullout centered in bottom section
(1) 24" deep shelf included for oven installation
OTK included at no charge

Oven Cabinet (Double) Full Access Construction

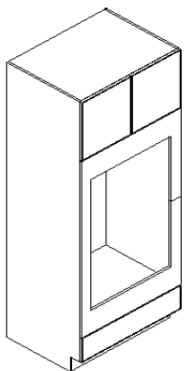

OC3084L	30	84	24	◆ (2) DR1518 (1) DH3006	No shelf in upper section
OC3384L	33	84	24	◆ (2) DR1618 (1) DH3306	
OC3090L	30	90	24	◆ (2) DR1524 (1) DH3006	(1) Adjustable shelf in upper section
OC3390L	33	90	24	◆ (2) DR1624 (1) DH3306	
OC3096L	30	96	24	◆ (2) DR1530 (1) DH3006	(1) Adjustable shelf in upper section
OC3396L	33	96	24	◆ (2) DR1630 (1) DH3306	
OC30102L	30	102	24	◆ (2) DR1536 (1) DH3006	(2) Adjustable shelves in upper section Standard Plywood sides
OC33102L	33	102	24	◆ (2) DR1636 (1) DH3306	Available in Carriage House Series only Not available in Gatehouse or Value Series

Loose Toekick

See page 91 for oven cabinet opening and trim size kits

(1) 24" deep shelf included for oven installation
OTK included at no-charge

Tall Cabinetry

Tall Cabinets

Width Height Depth Cabinet Door and Drawer Head

Oven Cabinet (Double) - Warming Drawer

Full Access Construction

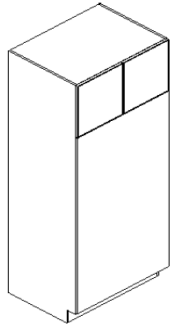

OC3084L-WDR	30	84	24	◆ (2) DR1518	No shelf in upper section
OC3384L-WDR	33	84	24	◆ (2) DR1618	
OC3090L-WDR	30	90	24	◆ (2) DR1524	(1) Adjustable shelf in upper section
OC3390L-WDR	33	90	24	◆ (2) DR1624	
OC3096L-WDR	30	96	24	◆ (2) DR1530	(1) Adjustable shelf in upper section
OC3396L-WDR	33	96	24	◆ (2) DR1630	
OC30102L-WDR	30	102	24	◆ (2) DR1536	(2) Adjustable shelves in upper section Standard Plywood sides
OC33102L-WDR	33	102	24	◆ (2) DR1636	Available in Carriage House Series only Not available in Gatehouse or Value Series

See page 91 for oven cabinet opening and trim size kits

(1) 24" deep shelf included for oven installation
OTKF included at no-charge

Loose Toekick

Oven Cabinet (Single) - Trim Kit Full

Full Access Construction

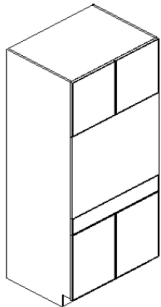

OC3084S-TKF	30	84	24	◆ (2) DR1518 (2) DR1524 (1) DH3006	No shelf in upper section
OC3384S-TKF	33	84	24	◆ (2) DR1618 (2) DR1624 (1) DH3306	
OC3090S-TKF	30	90	24	◆ (2) DR1524 (2) DR1524 (1) DH3006	(1) Adjustable shelf in upper section
OC3390S-TKF	33	90	24	◆ (2) DR1624 (2) DR1624 (1) DH3306	
OC3096S-TKF	30	96	24	◆ (2) DR1530 (2) DR1524 (1) DH3006	(1) Adjustable shelf in upper section
OC3396S-TKF	33	96	24	◆ (2) DR1630 (2) DR1624 (1) DH3306	
OC30102S-TKF	30	102	24	◆ (2) DR1536 (2) DR1524 (1) DH3006	(2) Adjustable shelves in upper section Standard Plywood sides
OC33102S-TKF	33	102	24	◆ (2) DR1636 (2) DR1624 (1) DH3306	Available in Carriage House Series only Not available in Gatehouse or Value Series

See page 91 for oven cabinet opening and trim size kits

GHS (1) 1/2-depth shelf in bottom section
CHS (1) Pullout centered in bottom section
(1) 24" deep shelf included for over installation
OTKF included at no charge

Loose Toekick

Oven Cabinet (Double) - Trim Kit Full

Full Access Construction

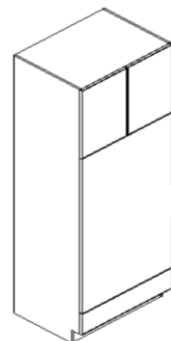

OC3084L-TKF	30	84	24	◆ (2) DR1518 (1) DH3006	No shelf in upper section
OC3384L-TKF	33	84	24	◆ (2) DR1618 (1) DH3306	
OC3090L-TKF	30	90	24	◆ (2) DR1524 (1) DH3006	(1) Adjustable shelf in upper section
OC3390L-TKF	33	90	24	◆ (2) DR1624 (1) DH3306	
OC3096L-TKF	30	96	24	◆ (2) DR1530 (1) DH3006	(1) Adjustable shelf in upper section
OC3396L-TKF	33	96	24	◆ (2) DR1630 (1) DH3306	
OC30102L-TKF	30	102	24	◆ (2) DR1536 (1) DH3006	(2) Adjustable shelves in upper section Standard Plywood sides
OC33102L-TKF	33	102	24	◆ (2) DR1636 (1) DH3306	Available in Carriage House Series only Not available in Gatehouse or Value Series

(1) 24" deep shelf included for over installation
OTKF included at no charge

Loose Toekick

See page 91 for oven cabinet opening and trim size kits

Tall Cabinetry

Tall Cabinets

Oven Trim Kit	Width	Height
OTKF3018	29 ¹⁵ / ₁₆	17 ¹ / ₂
OTKF3024	29 ¹⁵ / ₁₆	20
OTKF2721	26 ¹⁵ / ₁₆	20
OTKF3021	29 ¹⁵ / ₁₆	20
OTKF3324	32 ¹⁵ / ₁₆	24
OTK3030	29 ³ / ₄	30 ⁵ / ₈
OTK3330	32 ³ / ₄	30 ⁵ / ₈
OTK3054	29 ³ / ₄	54
OTK3354	32 ³ / ₄	54
OTKF3030	29 ³ / ₄	30 ⁵ / ₈
OTKF3330	32 ³ / ₄	30 ⁵ / ₈
OTKF3054	29 ³ / ₄	54
OTKF3354	32 ³ / ₄	54
OTKF3061	29 ³ / ₄	60 ⁷ / ₈
OTKF3361	32 ³ / ₄	60 ⁷ / ₈

Double Oven (Warming Drawer)

OTKF3061
or
OTKF3361

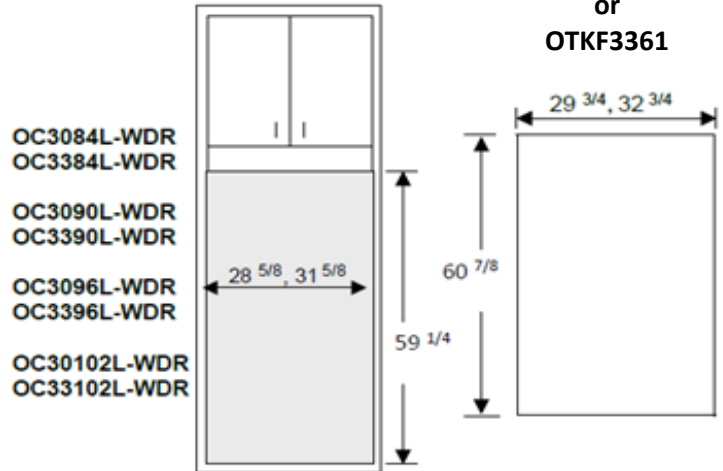

Single Oven

OTK3030 OR OTK3330

OTKF3030 or OTKF3330

OCS****S
OCS****S-TKF

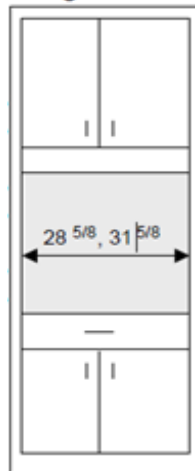

* Cut Out is Adjusted in field

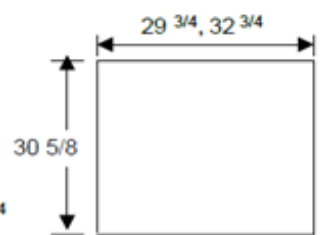
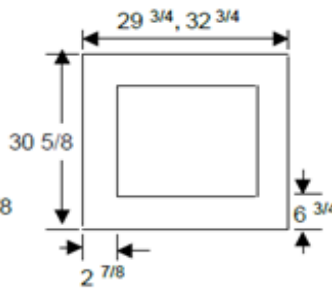

Double Oven

OTK3054 or OTK3354

OTKF3054 or OTKF3354

OCS****L
OCS****L-TKF

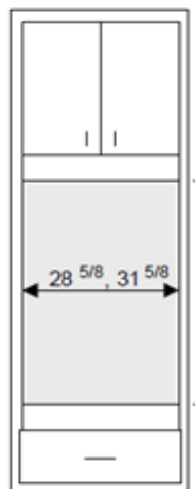

* Cut Out is Adjusted in field

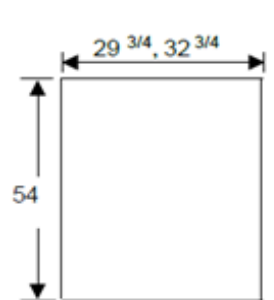
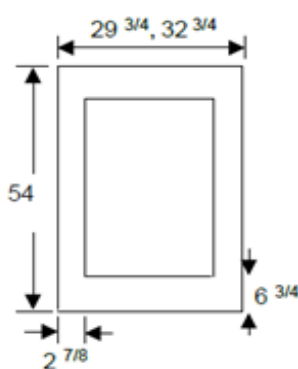

TAB: Vanity & Office Cabinetry

- *Index*
- *Construction Options & Modifications Key*
- *Cabinet Selection*

Vanity & Office Cabinetry

Page Location	Cabinet Type	Nomenclature
94	Construction Options & Modifications Key	
98	Apron Drawer	AD
98	Apron Drawer Keyboard	ADK
98	Desk File	DF
98	Deep Desk File	DDF
98	Desk Leg	DL
98	Hanging Apron Vanity Front	HAVF
97	Tank Topper	TT
95	Vanity Base	VB
96	Vanity Base Drawer	VBD
96	Vanity Base Double Drawer	VBDD
96	Vanity Base Drawer Base	VBDB
97	Vanity Base Drawer Full Height	VBDFH
97	Vanity Base Removable Front	VBRF
95	Vanity Base Space Saver	VBS
97	Vanity 1 Drawer	V1D
97	Vanity Drawer	VD
98	Vanity Drawer - ADA	VD-ADA
97	Vanity 4 Drawer	V4D
97	Vanity Linen	VL
95	Vanity Sink Base Space Saver	VSBS
96	Vanity Sink Base - False Drawer Heads	VSF
98	Vanity Sink Base Removable Front - Hanging Vanity - ADA	VSB-HV-ADA

Vanity & Office Cabinets

Finished Side Codes	
Description	Veneer Code
34 1/2" High Base/Vanity	BV34
84" Vanity Linen	BV84

Cabinet Modification Codes	
BOX	Box with no doors or drawer heads
364	Box Only (No drawers/pullouts/doors/drawerheads/shelves/hinges)
PLY	Plywood Sides
AWB	All Wood Box
DTG	Dovetail Drawer/Full Access Soft Close Glides *Gatehouse Series Only*

Vanity and Office Cabinetry

Vanity Cabinets

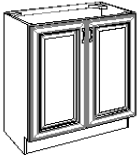
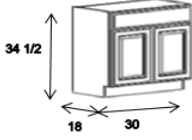
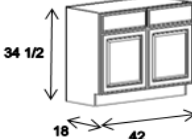
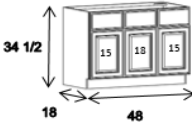
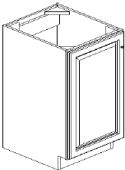
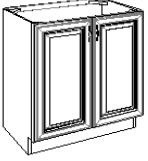
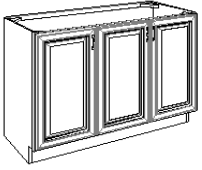
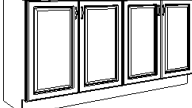
	Width	Height	Depth	Cabinet Door and Drawer Head		
Vanity Base Space Saver					Frame Construction	
	VBS24	24	34 1/2	18	◆ (2) DR1230	
	VBS27	27	34 1/2	18	◆ (2) DR1330	
	VBS30	30	34 1/2	18	◆ (2) DR1530	
	VBS33	33	34 1/2	18	◆ (2) DR1630	
	VBS36	36	34 1/2	18	◆ (2) DR1830	
Vanity Sink Base Space Saver					Frame Construction	
	VSBS24	24	34 1/2	18	◆ (1) DH2406 (2) DR1224	False Drawer Head
	VSBS27	27	34 1/2	18	◆ (1) DH2706 (2) DR1324	
	VSBS30	30	34 1/2	18	◆ (1) DH3006 (2) DR1524	
	VSBS33	33	34 1/2	18	◆ (1) DH3306 (2) DR1624	
	VSBS36	36	34 1/2	18	◆ (1) DH3606 (2) DR1824	
	VSBS42	42	34 1/2	18	◆ (2) DH2106 (2) DR2124	False Drawer Heads
	VSBS48	48	34 1/2	18	◆ (1) DH1806 (2) DH1506 ◆ (1) DR1824 (2) DR1524	2 1/4" Center Stile Offset to Left Middle Door is Always Hinged Left False Drawer Heads
	*DR1824 is the size of the middle door					
Vanity Base					Frame Construction	
	VB18 L/R	18	34 1/2	21	◆ (1) DR1830	
	VB21 L/R	21	34 1/2	21	◆ (1) DR2130	
	VB24	24	34 1/2	21	◆ (2) DR1230	
	VB27	27	34 1/2	21	◆ (2) DR1330	
	VB30	30	34 1/2	21	◆ (2) DR1530	
	VB33	33	34 1/2	21	◆ (2) DR1630	
	VB36	36	34 1/2	21	◆ (2) DR1830	
	VB42	42	34 1/2	21	◆ (2) DR2130	
	VB48	48	34 1/2	21	◆ (2) DR1530 (1) DR1830	2 1/4" Center Stile Offset to Left Middle Door is Always Hinged Left
	VB54	54	34 1/2	21	◆ (3) DR1830	
	VB60	60	34 1/2	21	◆ (2) DR2130 (1) DR1830	
*DR1830 is the size of the middle door						
	VB66	66	34 1/2	21	◆ (4) DR1630	2 1/4" Center Stile
	VB72	72	34 1/2	21	◆ (4) DR1830	

Vanity and Office Cabinetry

Vanity Cabinets

	Width	Height	Depth	Cabinet Door and Drawer Head		
Vanity Sink Base - False Drawer Heads					Frame Construction	
	VSB24	24	34 1/2	21	◆ (1) DH2406 (2) DR1224	
	VSB27	27	34 1/2	21	◆ (1) DH2706 (2) DR1324	
	VSB30	30	34 1/2	21	◆ (1) DH3006 (2) DR1524	
	VSB33	33	34 1/2	21	◆ (1) DH3306 (2) DR1624	
	VSB36	36	34 1/2	21	◆ (1) DH3606 (2) DR1824	
	VSB42	42	34 1/2	21	◆ (2) DH2106 (2) DR2124	
	VSB48	48	34 1/2	21	◆ (1) DH1806 (2) DH1506 (1) DR1824 (2) DR1524	2 1/4" Center Stile Offset to Left Middle Door is Always Hinged Left False Drawer Heads

*DR1824 is the size of the middle door

Vanity Base Drawer - 1 Door					Frame Construction	
	VBD30 L/R	30	34 1/2	21	◆ (1) DR1830 (1) DH1206 (2) DH1211	False Upper Drawer Head - No Hardware (2) Deep Drawers L/R designates position of drawers
	VBD33 L/R	33	34 1/2	21	◆ (1) DR1830 (1) DH1506 (2) DH1511	
	VBD36 L/R	36	34 1/2	21	◆ (1) DR2130 (1) DH1506 (2) DH1511	
	VBD39 L/R	39	34 1/2	21	◆ (1) DR2130 (1) DH1806 (2) DH1811	

*image shown as right





Vanity Base Drawer - 3 Door					Frame Construction	
	VBD42	42	34 1/2	21	◆ (2) DR1224 (1) DR1830 (2) DH1206	Single Bowl Configuration Only (2) Standard Drawers L and R Middle Door is Always Hinged Left
	VBD48	48	34 1/2	21	◆ (2) DR1524 (1) DR1830 (2) DH1506	
	VBD54	54	34 1/2	21	◆ (2) DR1824 (1) DR1830 (2) DH1806	
	VBD60	60	34 1/2	21	◆ (2) DR2124 (1) DR1830 (2) DH2106	
	VBD66	66	34 1/2	21	◆ (2) DR1530 (2) DR1824 (2) DH186	Single Bowl Configuration Only (2) Standard Drawers L and R Double Doors in Center Section
	VBD72	72	34 1/2	21	◆ (2) DR1830 (2) DR1824 (2) DH1806	

Vanity Base Double Drawer					Frame Construction	
	VBDD42	42	34 1/2	21	◆ (1) DR1830 (2) DH1206 (4) DH1211	Single Bowl Configuration Only (2) Standard Drawers L and R (4) Deep Drawers L and R
	VBDD45	45	34 1/2	21	◆ (1) DR2130 (2) DH1206 (4) DH1211	
	VBDD48	48	34 1/2	21	◆ (1) DR1830 (2) DH1506 (4) DH1511	
	VBDD54	54	34 1/2	21	◆ (1) DR1830 (2) DH1806 (4) DH1811	
	VBDD60	60	34 1/2	21	◆ (2) DR1530 (2) DH1506 (4) DH1511	

Vanity Base Drawer Base					Frame Construction	
	VBDB54	54	34 1/2	21	◆ (2) DR1830 (1) DH1806 (2) DH1811	Double Bowl Configuration Only VBDB54 has 12" wide core/18" wide drawer head VBDB60/66/72 have 15" wide core/18" wide drawer head (2) Deep Lower Drawers - core and drawer heads are 18" wide
	VBDB60	60	34 1/2	21	◆ (2) DR2130 (1) DH1806 (2) DH1811	
	VBDB66	66	34 1/2	21	◆ (4) DR1230 (1) DH1806 (2) DH1811	
	VBDB72	72	34 1/2	21	◆ (4) DR1330 (1) DH1806 (2) DH1811	

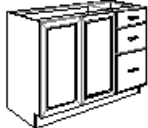
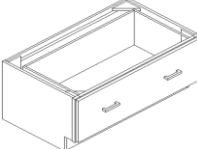
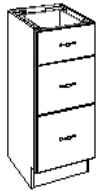
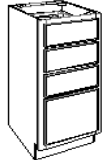
Vanity and Office Cabinetry

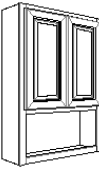
Vanity Cabinets

	Width	Height	Depth	Cabinet Door and Drawer Head	Frame Construction	
Vanity Base Drawer Full Height						
	VBDFH45 L/R	45	34 1/2	21	◆ (2) DR1530 (1) DH1506 (2) DH1511	Single Bowl Left or Right (1) Standard Drawer
	VBDFH48 L/R	48	34 1/2	21	◆ (2) DR1630 (1) DH1506 (2) DH1511	(2) Deep Drawers
	VBDFH54 L/R	54	34 1/2	21	◆ (2) DR1830 (1) DH1806 (2) DH1811	(2) Full Height Doors L/R designates position of drawers
	*image shown as right					
Vanity 1 Drawer						
	V1D18	18	16	21	◆ (1) DH1811	(1) Deep Drawer
	V1D21	21	16	21	◆ (1) DH2111	
	V1D24	24	16	21	◆ (1) DH2411	
	V1D27	27	16	21	◆ (1) DH2711	
	V1D30	30	16	21	◆ (1) DH3011	
	V1D33	33	16	21	◆ (1) DH3311	
	V1D36	36	16	21	◆ (1) DH3611	
Vanity Drawer						
	VD12	12	34 1/2	21	◆ (1) DH1206 (2) DH1211	(1) Standard Drawer (2) Deep Drawers
	VD15	15	34 1/2	21	◆ (1) DH1506 (2) DH1511	
	VD18	18	34 1/2	21	◆ (1) DH1806 (2) DH1811	
	VD21	21	34 1/2	21	◆ (1) DH2106 (2) DH2111	
	VD24	24	34 1/2	21	◆ (1) DH2406 (2) DH2411	
	VD27	27	34 1/2	21	◆ (1) DH2706 (2) DH2711	
	VD30	30	34 1/2	21	◆ (1) DH3006 (2) DH3011	
	VD33	33	34 1/2	21	◆ (1) DH3306 (2) DH3311	
Vanity 4 Drawer						
	V4D12	12	34 1/2	21	◆ (3) DH1206 (1) DH1209	(3) Standard Upper Drawers (1) Deep Lower Drawer
	V4D15	15	34 1/2	21	◆ (3) DH1506 (1) DH1509	
	V4D18	18	34 1/2	21	◆ (3) DH1806 (1) DH1809	
	V4D21	21	34 1/2	21	◆ (3) DH2106 (1) DH2109	
	V4D24	24	34 1/2	21	(3) DH2406 (1) DH2409	
Vanity Linen						
	VL188421 L/R	18	84	21	◆ (1) DR1861 (1) DR1818	Loose Toekick Includes 4 Adjustable Shelves
Tank Topper						
	TT2436	24	36	9	◆ (2) DR1224	Finished Interior and Exterior in Matching Color is STANDARD (Including Shelf) Opening is 12" High
Vanity Base Removable Front						
	VBRF33-ADA	33	32 1/2	21	◆ (2) DR1628.5	Face frame removable Removable floor
	VBRF36-ADA	36	32 1/2	21	◆ (2) DR1828.5	ADA adaptable
	N/A with raised panel door styles					

Vanity and Office Cabinetry

Vanity Cabinets

	Width	Height	Depth	Cabinet Door and Drawer Head	
Vanity Sink Base - Hanging Vanity - ADA					Frame Construction
	VSB33-HV-ADA	33	32 1/2	21	◆ (1) DH3304.5 (2) DR1624
	VSB36-HV-ADA	36	32 1/2	21	◆ (1) DH3604.5 (2) DR1824

Can be used alone or with HAVF for later conversion. Removable; no back.

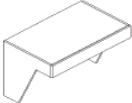
	Width	Height	Depth	Cabinet Door and Drawer Head	
Hanging Apron Vanity Front					Frame Construction
	HAVF3321	28 1/2	21	19 3/4	
	HAVF33213621	31 1/2	21	19 3/4	

Can be used alone or with VSB-HV-ADA - Vanity Sink Base - Hanging Vanity - ADA

Office Cabinets

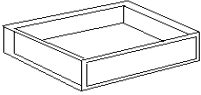
	Width	Height	Depth	Cabinet Door and Drawer Head	
Apron Drawer					Full Access Construction
	AD18/24	24	5 3/8	21	◆ (1) DH1805
	AD24	24	5 3/8	21	◆ (1) DH2405
	AD30	30	5 3/8	21	◆ (1) DH3005
	AD36	36	5 3/8	21	◆ (1) DH3605

18" Drawer with (2) 3" Trimmable Ears on Each Side

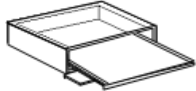
	Width	Height	Depth	Cabinet Door and Drawer Head	
Apron Drawer Keyboard					Full Access Construction
	ADK24	24	5 3/8	21	◆ (1) DH2405-ADK
	ADK30	30	5 3/8	21	◆ (1) DH3005-ADK
	ADK36	36	5 3/8	21	◆ (1) DH3605-ADK

For CHS: Has slab drawer head with bead detail due to hinges

	Width	Height	Depth	Cabinet Door and Drawer Head	
Desk File					Full Access Construction
	DF1529	15	29 1/2	21	◆ (1) DH1505 (1) DH1506 (1) DH1512
	DF1829	18	29 1/2	21	◆ (1) DH1805 (1) DH1806 (1) DH1812

Bottom Drawer Holds File Folders

	Width	Height	Depth	Cabinet Door and Drawer Head	
Deep Desk File					Full Access Construction
	DDF1529	15	29 1/2	21	◆ (2) DH1512
	DDF1829	18	29 1/2	21	◆ (2) DH1812
	DDF3029	30	29 1/2	21	◆ (2) DH3012
	DDF3629	36	29 1/2	21	◆ (2) DH3612

Both Drawers Hold File Folders

Both Drawers Hold File Folders - Stored Laterally

Available in Carriage House Series Only

	Width	Height	Depth	Cabinet Door and Drawer Head	
Desk Leg					Full Access Construction
	DL21	5/8	29 1/2	21	
	DL21-PLY				

Attaches to the outside of the Apron Drawer (AD) or Apron Drawer Keyboard (ADK)

Vanity Drawer-ADA

	Width	Height	Depth	Cabinet Door and Drawer Head	
	VD12-ADA	12	31 1/2	21	◆ (1) DH1206 (1) DH1209 (2) DH1211
	VD15-ADA	15	31 1/2	21	◆ (1) DH1506 (1) DH1509 (2) DH1511
	VD18-ADA	18	31 1/2	21	◆ (1) DH1806 (1) DH1809 (2) DH1811
	VD21-ADA	21	31 1/2	21	◆ (1) DH2106 (1) DH2109 (2) DH2111

TAB: Fillers, Panels &
Accessories

Fillers and Panels

- *Index*
- *Fillers*
- *End Panels*
- *End Fillers*
- *Decorative End Panels*

Fillers & Panels

Page Location	Cabinet Type	Nomenclature
101	Alumasteel Filler	F-ALMSTL
105	Alumasteel Liner	ALMSTL
103	Angle Fillers	F45
102	Corner Filler	CF
102	Corner Filler Overlay	CF-OL
103	Diagonal Filler Inside Corner	DRFIC
103	Diagonal Filler Inside Corner "Shaker"	DFICS
101	End Corner Filler	ECF
106	End Filler Flat	EFF
106	End Filler Overlay	EFO
106	End Filler Flat Narrow	EFFN
107	End Filler with Return	EFF-R
107	End Filler Overlay with Return	EFFO-R
107	End Filler Flat Narrow with Return	EFFN-R
105	End Panel Base "Skin"	EPB, VDPB
105	End Panel Wall "Skin"	EPW, VEPW
105	End Panel	EP, EP-PLY
108-109	End Panel Door Program	EPDR
101	Fillers	F
101	Fillers with Overlay	F-OL
104	Filler "Shaker"	FS
105	Laminate Sheets	LAMINATE
105	Panel Backer	PB
105	Panel Backer Beaded	PBB
102	Starter Filler	F58

Fillers and Panels

Fillers

	Length	Width	Thickness	
--	--------	-------	-----------	--

Fillers (GHS and CHS)

	F1/30	30 ^{9/16}	1	3/4	Solid stock
	F3/30	30 ^{9/16}	3	3/4	Solid stock
	F6/30	30 ^{9/16}	6	3/4	Plywood
	F3/42	41 ^{7/8}	3	3/4	Solid stock
	F6/42	41 ^{7/8}	6	3/4	Plywood
	F3/96*	96	3	3/4	* Edges are finished; Plywood
	F6/96*	96	6	3/4	* Edges are finished; Plywood
	F3/102	102	3	3/4	Plywood
	F3/114	114	3	3/4	Plywood
	F6/114	114	6	3/4	Plywood

Fillers with Overlay (Carriage House Series Only)

	F3/30-OL	30 ^{9/16}	3	1 ^{1/2}	Unfinished ends on backer
	F6/30-OL	30 ^{9/16}	6	1 ^{1/2}	
	F3/36-OL	36	3	1 ^{1/2}	
	F6/36-OL	36	6	1 ^{1/2}	
	F3/42-OL	41 ^{7/8}	3	1 ^{1/2}	
	F6/42-OL	41 ^{7/8}	6	1 ^{1/2}	
	F3/96-OL	96	3	1 ^{1/2}	
	F3/102-OL	102	3	1 ^{1/2}	

Alumasteel Filler

	F3/30-ALMSTL	30 ^{9/16}	3	3/4
	F3/36-ALMSTL	36	3	3/4
	F3/48-ALMSTL	48	3	3/4

End Corner Filler

	ECF96	96	3/4	3/4

Fillers and Panels

Fillers

Starter Fillers

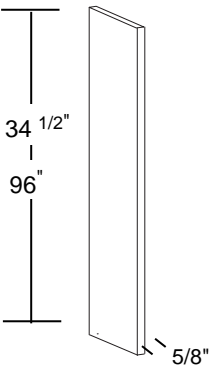
	Length	Width	Thickness	
	F58/30	34 ^{1/2}	4	5/8
	F58/96	96	4	5/8

Starter filler used to create space between the cabinet and the wall to allow doors and drawers to open properly

Edge - banded side is the 5/8" thick finished side

Corner Filler (GHS and CHS)

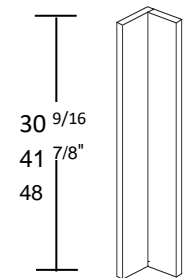
	CF3/30	30 ^{9/16}	3	3	Corner Filler 3x3 with Overlay Provides 3" Clearance in Each Direction
	CF3/42	41 ^{7/8}	3	3	
	CF3/48	48	3	3	

Corner Filler Overlay (CHS)

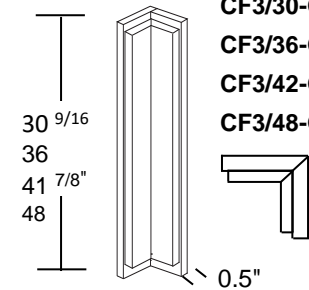
	CF3/30-OL	30 ^{9/16}	3	3	Corner Filler 3x3 with Overlay Provides 3" Clearance in Each Direction
	CF3/36-OL	36	3	3	
	CF3/42-OL	41 ^{7/8}	3	3	
	CF3/48-OL	48	3	3	

Fillers and Panels

Fillers

Angle Fillers

	Length	Width	Thickness
F45	30 ⁹ / ₁₆ "	3/4"	5/8"

Diagram Labels: 30 ⁹/₁₆" (Length), 3/4" (Rear), 5/8" (Exposed), 22 ¹/₂° angle, 45°

Diagonal Filler Inside Corner

	Length	Width	Thickness
DRFIC3X3/30	30 ⁹ / ₁₆ "	4 ¹ / ₈ "	1 ¹ / ₂ "
DRFIC3X3/36	36"	4 ¹ / ₈ "	1 ¹ / ₂ "
DRFIC3X3/42	41 ⁷ / ₈ "	4 ¹ / ₈ "	1 ¹ / ₂ "
DRFIC3X3/48	48 ⁹ / ₁₆ "	4 ¹ / ₈ "	1 ¹ / ₂ "
DRFIC3X3/96	96"	4 ¹ / ₈ "	1 ¹ / ₂ "

Diagram Labels: 4" (Width), 30 ⁹/₁₆" (Length), 36" (Length), 41 ⁷/₈" (Length), 48" (Length), 96" (Length), 3/4" (Backer), 2 ¹/₄" (Width), Top View

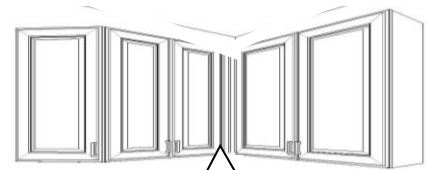

Diagonal Inside Corner Filler

Crown molding should overlay the filler

Diagonal Filler Inside Corner "Shaker"

	Length	Width	Thickness
DFICS0330	30 ⁹ / ₁₆ "	4 ¹ / ₈ "	1 ¹ / ₂ "
DFICS0336	36"	4 ¹ / ₈ "	1 ¹ / ₂ "
DFICS0342	41 ⁷ / ₈ "	4 ¹ / ₈ "	1 ¹ / ₂ "
DFICS0348	48 ⁹ / ₁₆ "	4 ¹ / ₈ "	1 ¹ / ₂ "

Diagram Labels: 3" (Width), 30 ⁹/₁₆" (Length), 36" (Length), 41 ⁷/₈" (Length), 48" (Length), 7 ³/₈" (Depth)

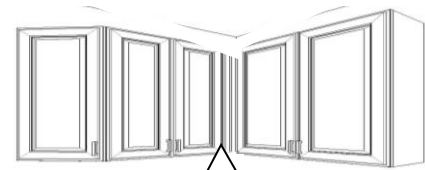

Diagonal Inside Corner Filler Shaker

Crown molding should overlay the filler

Fillers and Panels

Fillers

Filler "SHAKER"

Length Width Thickness

Part Number	Length	Width	Thickness
FS0330	30 ^{9/16}	3	1 1/2
FS0335	35	3	1 1/2
FS0336	36	3	1 1/2
FS0342	41 ^{7/8}	3	1 1/2
FS0348	48	3	1 1/2
FS0354	54	3	1 1/2
FS0360	60	3	1 1/2
FS0384	84	3	1 1/2
FS0390	90	3	1 1/2
FS0396	96	3	1 1/2
FS03102	102	3	1 1/2

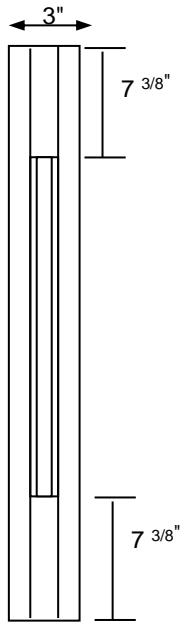

Front View

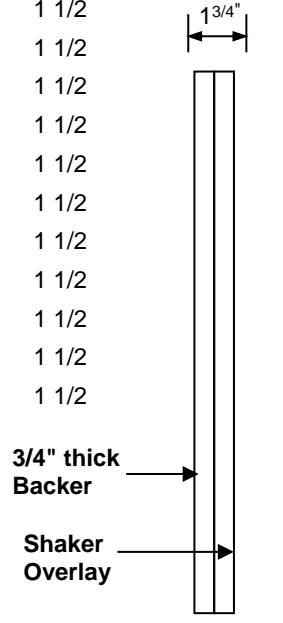

Side View

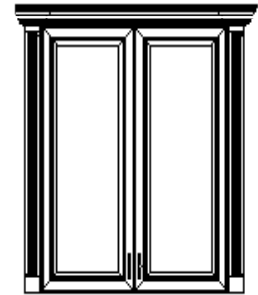
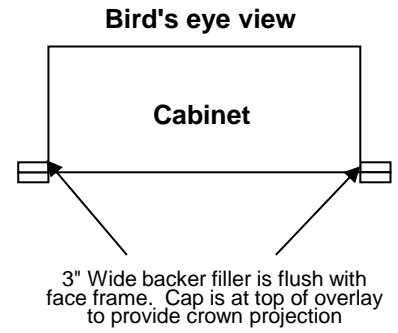

Fillers and Panels

End Panels

End Panels (Skins)

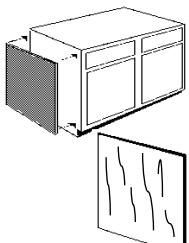
		Length	Width	Thickness	
	EPB34	23 ^{1/4}	30 ^{9/16}	1/32	EPB AND EPW Fit behind the face frame of unfinished cabinet sides and are 1/32" thick VEPB AND VEPW Fit behind the face frame of unfinished cabinet sides and are available as painted or stained
	EPW48	11 ^{1/4}	41 ^{7/8}	1/32	
	VEPB34	23 ^{1/4}	30 ^{9/16}	1/32	
	VEPW48	11 ^{1/4}	48	1/32	

Panel Backer

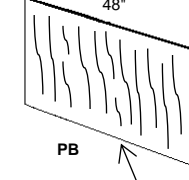
	PB34	48	34 ^{1/2}	1/4	Plywood has an MDF core for stability
	PB48	48	48	1/4	
	PB34-PLY	48	34 ^{1/2}	1/4	
	PB48-PLY	48	48	1/4	

Grain runs vertical

Panel Backer Beaded

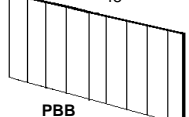
	PBB34	48	34 ^{1/2}	1/4	Wood Finishes are 1/4" thick Veneer Stained Painted Finishes are 1/4" thick Medium Density Fiberboard (MDF)
	PBB48	48	48	1/4	

End Panels 5/8" Thick

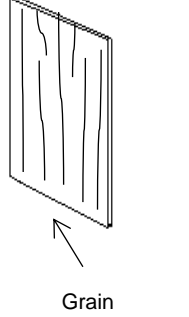
	EP34	24	34 ^{1/2}	5/8	Edge banded both long edges Finished both sides
	EP96	24	96	5/8	
	EP102	24	102	5/8	Plywood Construction
	EP114	24	114	5/8	
	EP3096	30	96	5/8	
	EP30102	30	102	5/8	
	EP34-PLY	24	34 ^{1/2}	5/8	
	EP96-PLY	24	96	5/8	
	EP102-PLY	24	102	5/8	
	EP114-PLY	24	114	5/8	
	EP3096-PLY	30	96	5/8	
	EP30102-PLY	30	102	5/8	

Laminate Sheets

	LAMINATE4X4	48	48	1/32	Cut to Size in Field
	LAMINATE4X8	96	48	1/32	

Alumasteel Liner

	ALMSTL3624	36	24	3/4
	ALMSTL4824	48	24	3/4
	ALMSTL6024	60	24	3/4

Fillers and Panels

End Fillers

EFF End Filler Flat



	Depth	Height	Width
EFF34	24	34 1/2	3
EFF96	24	96	3
EFF102	24	102	3
EFF114	24	114	3
EFF3096	30	96	3
EFF30114	30	114	3
EFF34QR	24	34 1/2	3

The flat filler is attached directly to the end panel
There is a 1/4" reveal on EFF34QR - side

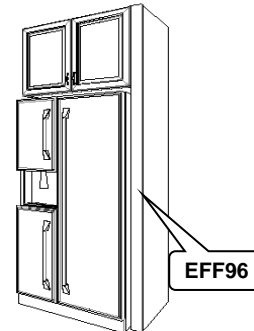
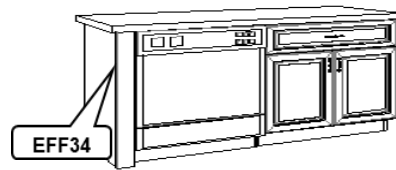

EFO End Filler Overlay (CHS Only)

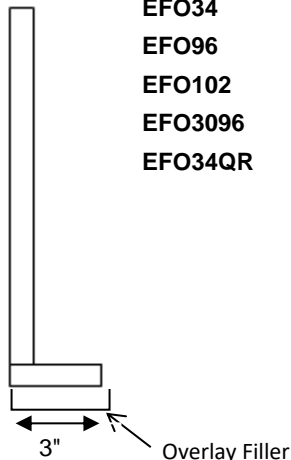

EFO34	24 3/4	34 1/2	3
EFO96	24 3/4	96	3
EFO102	24 3/4	102	3
EFO3096	30 3/4	96	3
EFO34QR	24 3/4	34 1/2	3

The overlay filler has a backer piece which is attached to the end panel
There is 1/2" reveal at the top of the filler to accommodate crown molding
There is a 1/4" reveal on EFO34QR - side

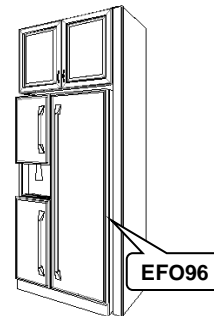
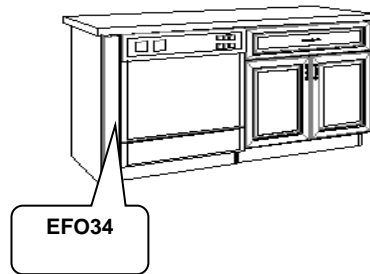

EFFN End Filler Flat Narrow

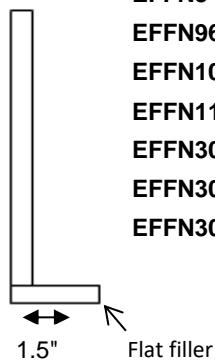

EFFN34	24	34 1/2	1 1/2
EFFN96	24	96	1 1/2
EFFN102	24	102	1 1/2
EFFN114	24	114	1 1/2
EFFN3096	30	96	1 1/2
EFFN30102	30	102	1 1/2
EFFN30114	30	114	1 1/2

The flat filler is attached directly to the end panel

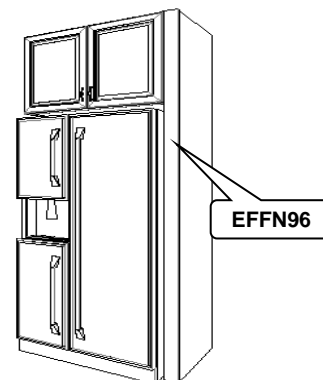
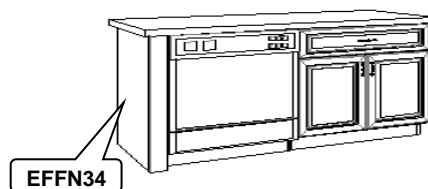

Fillers and Panels

End Fillers

EFF End Filler With Return

Depth Height Width

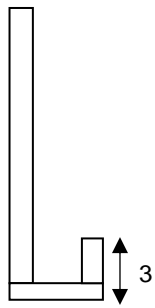

EFF34-R	24	34 1/2	3
EFF96-R	24	96	3
EFF102-R	24	102	3
EFF114-R	24	114	3
EFF3096-R	30	96	3
EFF30114-R	30	114	3
EFF34QR-R	24	34 1/2	3

The flat filler is attached directly to the end panel
There is a 1/4" reveal on EFF34QR - side

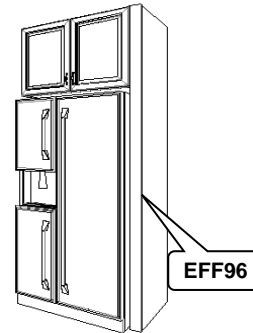
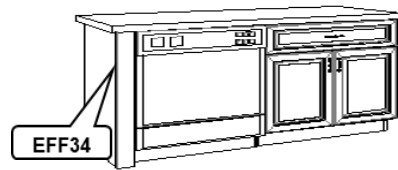

EFO End Filler Overlay With Return (CHS Only)

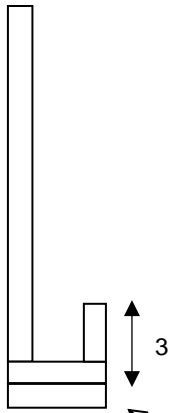

EFO34-R	24 3/4	34 1/2	3
EFO96-R	24 3/4	96	3
EFO102-R	24 3/4	102	3
EFO3096-R	30 3/4	96	3
EFO34QR-R	24 3/4	34 1/2	3

The overlay filler has a backer piece which is attached to the end panel
There is 1/2" reveal at the top of the filler to accommodate crown molding
There is a 1/4" reveal on EFO34QR - side

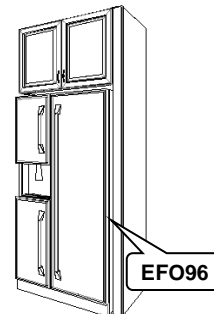
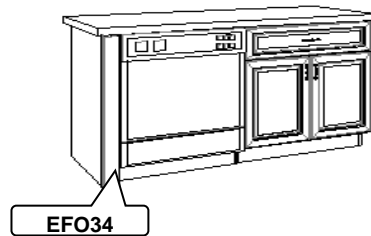

EFFN End Filler Flat Narrow With Return

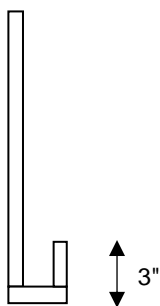

EFFN34-R	24	34 1/2	1 1/2
EFFN96-R	24	96	1 1/2
EFFN102-R	24	102	1 1/2
EFFN114-R	24	114	1 1/2
EFFN3096-R	30	96	1 1/2
EFFN30102-R	30	102	1 1/2
EFFN30114-R	30	114	1 1/2

The flat filler is attached directly to the end panel

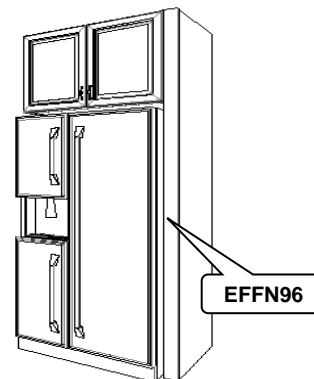
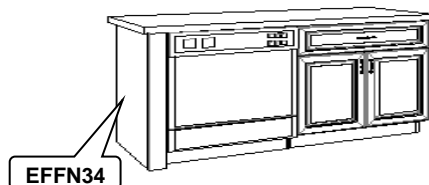

Fillers and Panels

End Panel Door Program (EPDR)

- End Panel Doors (EPDR) are decorative door panels that can be ordered as separate items and applied to the finished ends of Wall, Base and Tall Cabinets.
- EPDR's are made of 3/4" deeper than the cabinet side.
- Front edge of the End Panel Door covers the face frame.
- Meets the edge of the door on the front of the cabinet.
- The back edge of the End Panel Door is flat so that it butts up against the wall evenly.
- The front, top and bottom edges of the End Panel Door are detailed to match the edges of the cabinet doors based upon the cabinet series you are ordering.

Note: *Since the back edge of the EPDR is flat, these should not be used to wrap around islands and peninsulas. The EPDR is designed to be used as a decorative door panel on the sides of cabinets that butt up against a wall.*

You must designate **finished ends** for all cabinets that will be receiving the decorative End Panel Doors (EPDR)

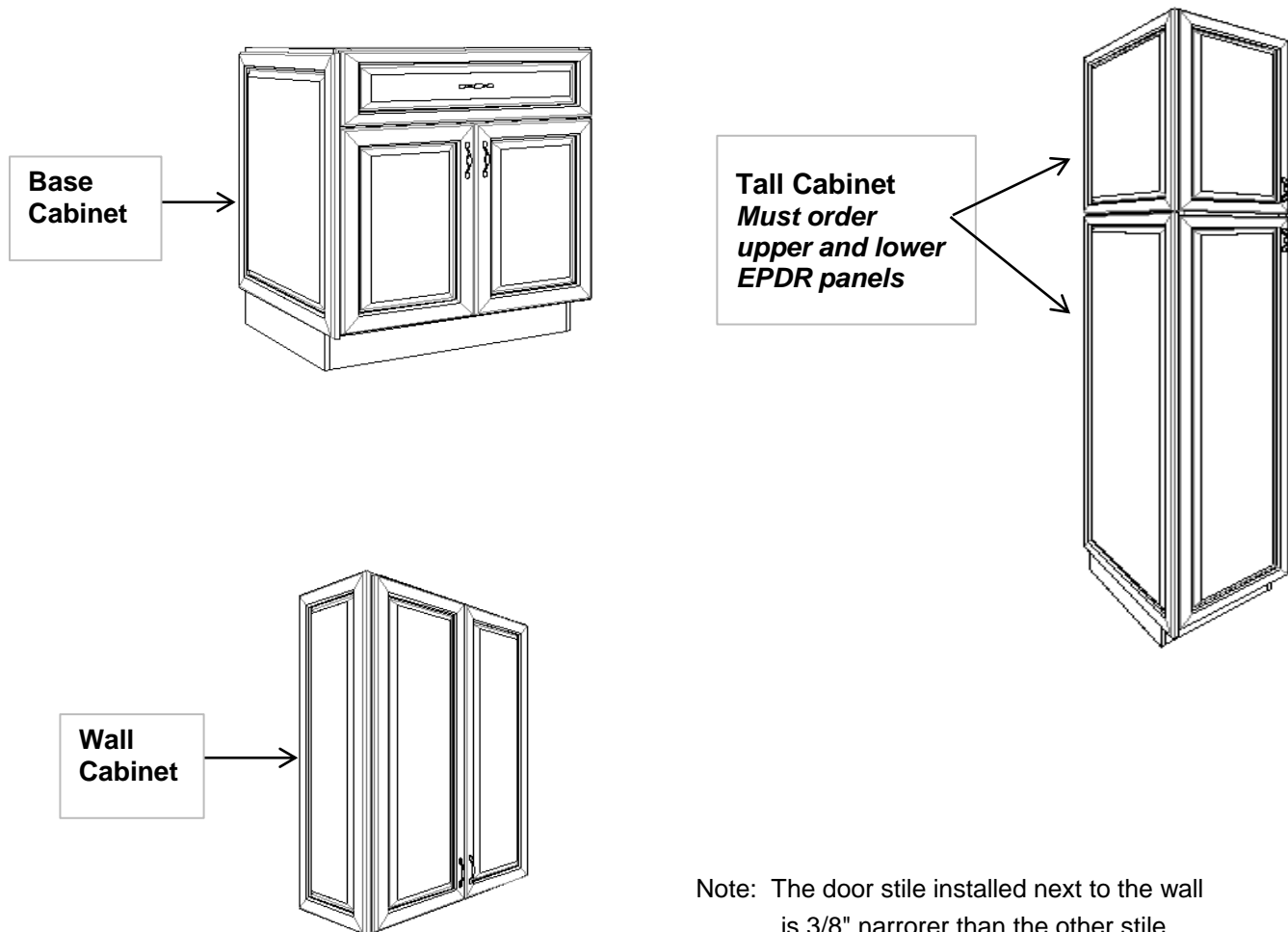

Note: The door stile installed next to the wall is 3/8" narrower than the other stile.

Filler and Panels

End Panel Door Program (EPDR)

End Panel Door Code		Width		Height	
WALL	EPDR1218	12 ^{13/16}	X	16 ^{27/32}	
	EPDR1224	12 ^{13/16}	X	22 ^{15/32}	
	EPDR1230	12 ^{13/16}	X	29 ^{13/32}	
	EDPR1830	18 ^{13/16}	X	29 ^{13/32}	
	EPDR1236	12 ^{13/16}	X	34 ^{21/25}	
	EPDR2436	24 ^{13/16}	X	34 ^{5/6}	
	EPDR1242	12 ^{13/16}	X	40 ^{18/25}	
	EPDR1248	12 ^{13/16}	X	47	
	EPDR2448	24 ^{13/16}	X	47	
	EPDR1261	12 ^{13/16}	X	61 ^{7/32}	
	EPDR2442	24 ^{13/16}	X	40 ^{18/25}	
DESK	EPDR2125	21 ^{13/16}	X	24 ^{3/8}	
VANITY	EPDR2130	21 ^{13/16}	X	29 ^{13/32}	
BASE	EPDR2430	24 ^{13/16}	X	29 ^{13/32}	
TALLS					
UPPER	EPDR2418	24 ^{13/16}	X	16 ^{17/32}	
	EPDR2424	24 ^{13/16}	X	22 ^{15/32}	
	EPDR2430	24 ^{13/16}	X	29 ^{13/32}	
LOWER	EPDR2461	24 ^{13/16}	X	61 ^{7/32}	

Accessories

- *Index*
- *Standard and Upgraded Hardware*
- *Cutlery Tray Inserts*

Accessories

Page Location	Item Type	Nomenclature
112	Standard and Upgraded Hardware	HWD
113	Upgraded 2 Hardware	HWD
114	Cutlery Tray Drawer Insert	CT
114	Knife Block Drawer Insert	KNF9
114	3" Spacer Drawer Insert	S3
114	Spice Tray Drawer Insert	SPC6
114	Utility Tray Drawer Insert	UT9
114	Peg Board Drawer Insert	PBDI

Accessories

STANDARD HARDWARE



UPGRADED HARDWARE



UPGRADED 2 HARDWARE



TK857BSN



TK857AG



TK857BLK



TK857HB



TK946BSN



TK946AG



TK946BLK



TK946HB



TK909BSN



TK909AG



TK909BLK



TK909HB



TK888BSN



TK888AG



TK888BLK



TK888HB



TK708BSN



TK708AG



TK708BLK



TK708HB

Accessories

CUTLERY DRAWER PROGRAM

Item Code	Description	Width	Depth	Height	Material
CT15	Cutlery Tray	10 3/4"	19 1/2"	2 31/32"	1/2" Thick Finished Plywood
UT9	Utility Tray	9"	19 1/2"	3"	1/2" Thick Finished Plywood
SPC6	Spice Tray	6"	19 1/2"	1 1/3"	3/4" Solid Maple
KNF9	Knife Tray	9"	19 1/2"	1 9/16"	Bottom is 1/2" Finished Plywood Knife Block with (8) slots is 1 1/6" Thick Solid Maple Handle Rest is 3/4" Thick Solid Maple
S3	Spacer 3"	3"	19 1/2"	1/2"	1/2" Finished Plywood Spacer
PBD130	Peg Board Drawer Insert	25 3/4"	19 1/2"	6 5/8"	5/8" Thick Finished Plywood, Solid Wood Pegs
PBD133	Peg Board Drawer Insert	28 3/4"	19 1/2"	6 5/8"	5/8" Thick Finished Plywood, Solid Wood Pegs
PBD136	Peg Board Drawer Insert	31 3/4"	19 1/2"	6 5/8"	5/8" Thick Finished Plywood, Solid wood Pegs

*These Items Are Available for Carriage House Only

**Can be Ordered As Individual Item Codes Above, or As An Assembly By Drawer Size. (SEE ITEM CODES BELOW)

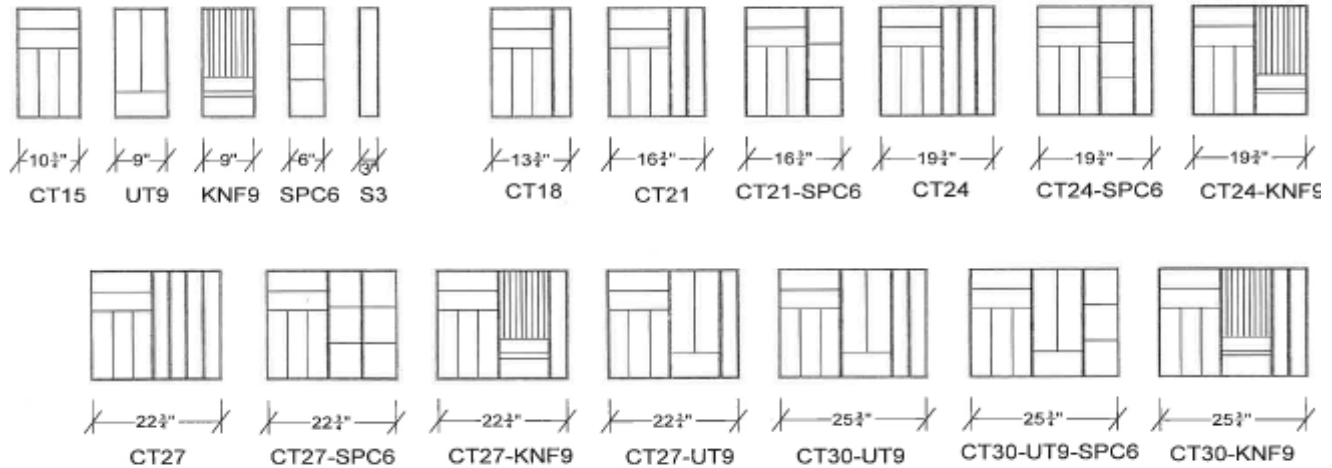

Item Code: PBDI30

PBDI33

PBDI36

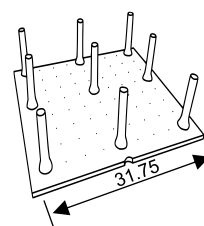
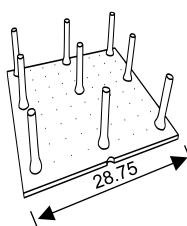
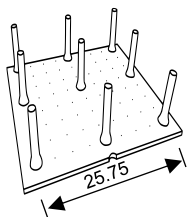

Items Included: Peg Board Drawer Insert
(4) Pegs

TAB: Moldings & Decorative
Accessories

Molding and Decorative Accessories

- *Index*
- *Moldings*
- *Legs, Posts & Plate Covers*
- *Corbels & Brackets*
- *Arched Valances & Mantels*
- *Toekick & Feet*

Moldings & Decorative Accessories

Page Location	Item Type	Nomenclature
121	Arched Radius Decorative Valance	ARDV
121	Arched Valance	AV
121	Arched Valance "Shaker"	AVS
121	Shaker Bunn Foot	BTF
119	Bottom Casement Molding	BCM8
119	Beaded Top/Bottom Molding	BTBM8
120	Counterbalance Bracket	CBPL
120	Corbel - Shaker	CS
119	Crown Molding	CM8
119	Crown Molding "Angled"	CMA10
119	Crown Molding "Coved"	CMC10
119	Crown Molding "Small"	CMS8
119	Crown Molding "Large"	CMT10
118	Custom Shelf Kit	CSK
118	Floating Shelves	FLSH
118	Furniture Toekick	FTK8
118	Inside Corner Molding	ICM8
120	L Bracket "Shaker"	LBS
118	Light Valance Molding	LVM8
118	Light Valance Shaker Molding	LVSH8
122	Mantel	MANTEL
122	Mantel "Shaker"	MS
118	Mirror Trim	MT8
118	Outside Corner Molding	OCM8
119	Straight Leg	P42-5
119	Tapered Leg	P43-5
119	Hour Glass Leg	P82-5
119	Farm Legs	P13
119	Pilaster Legs	PIL
120	Plates - Outlet Covers	PLATE
119	Pilaster Shaker Legs	PLS
118	Shoe Molding	SHOE8
119	Scribe	SS8
121	Straight Valance	SV
119	Top Casement Molding	TCM8
118	Toekick Cover	TKC8
122	Toekick Cover - Arched	TKCA
118	Toekick End	TKE
118	Valance	V4M

Molding and Decorative Accessories

Moldings

Crown Molding Angled

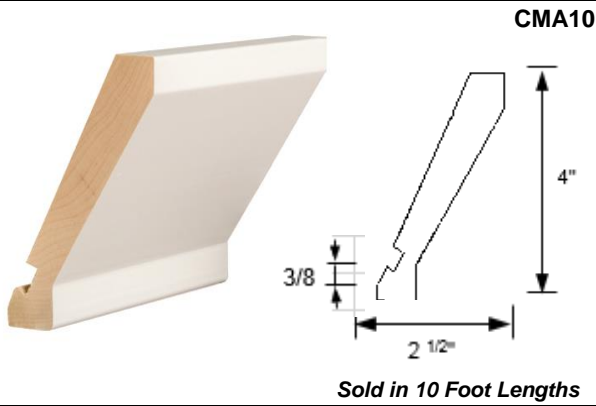

Crown Molding

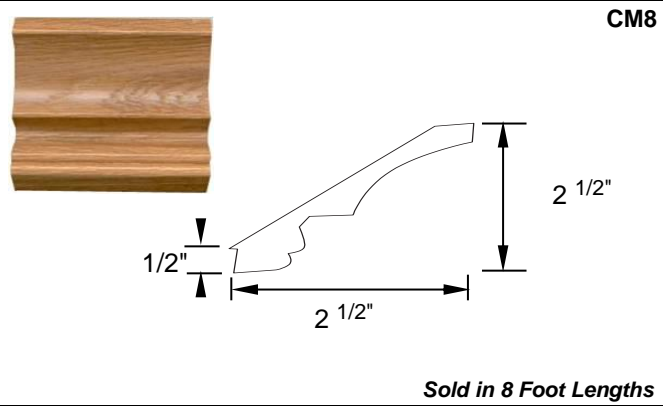

Crown Molding Coved

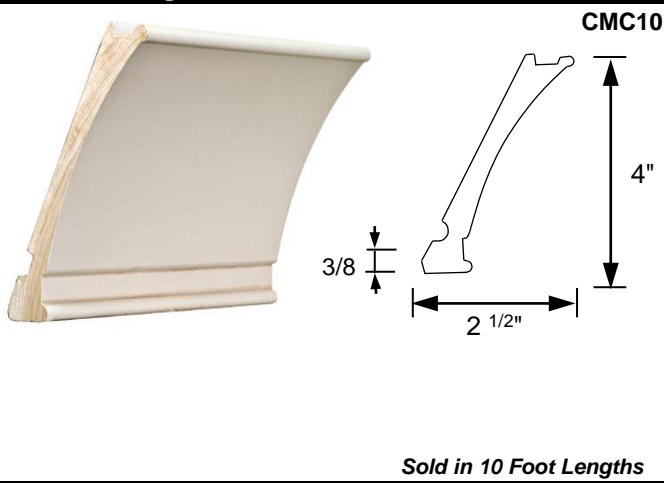

Crown Molding "Small"

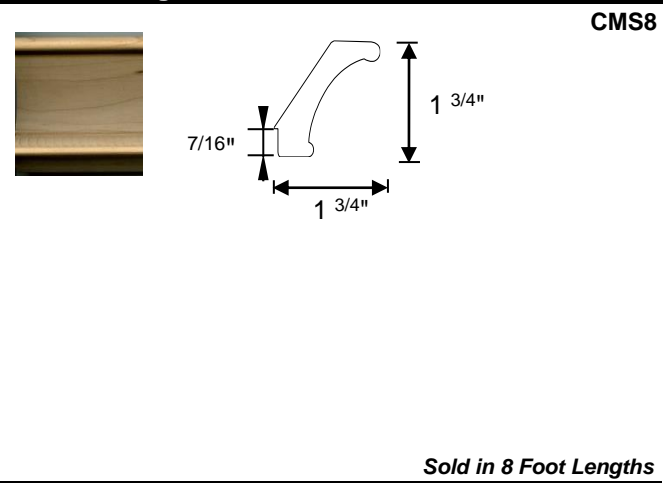

Crown Molding Large

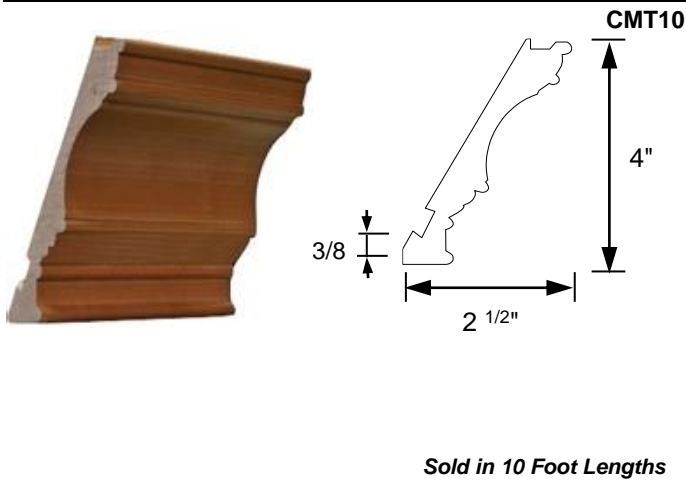

Scribe Molding

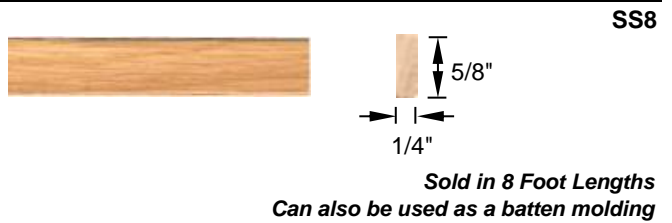

Beaded Top Bottom Molding

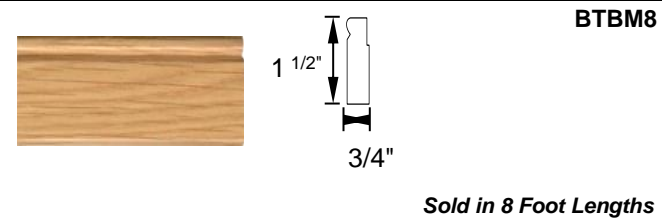

Top Casement Molding

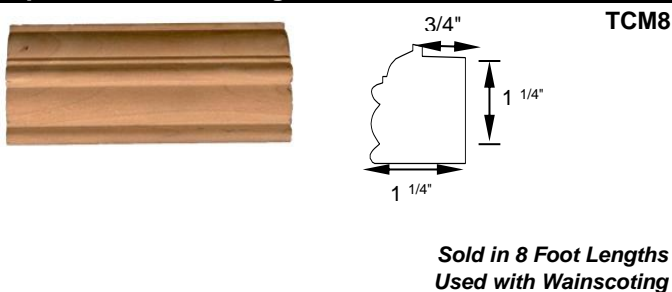

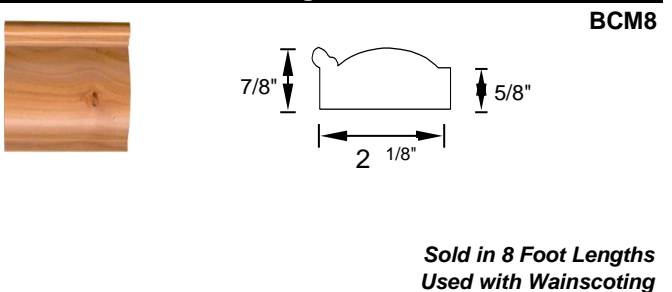

Bottom Casement Molding

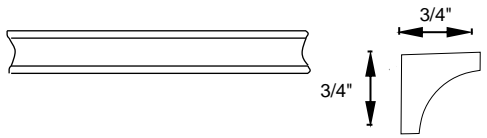
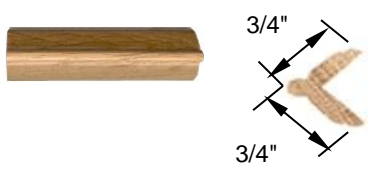
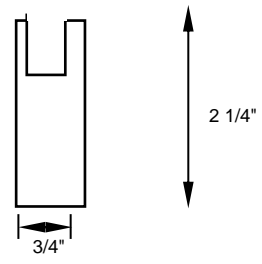
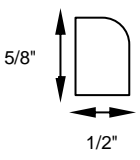
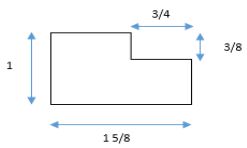
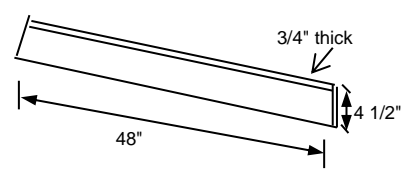

Molding and Decorative Accessories

Moldings

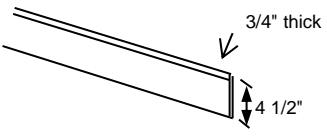
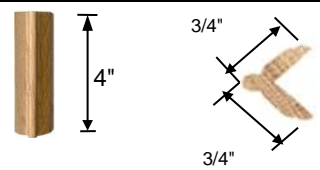
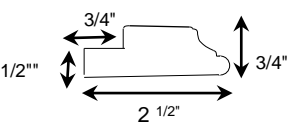
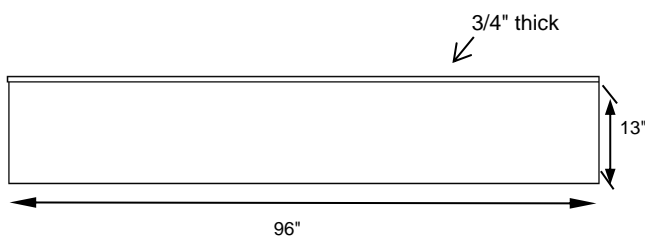
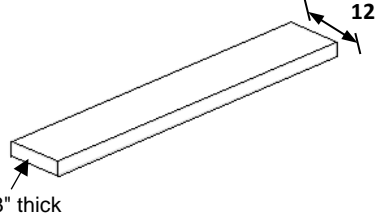
<p>Inside Corner Molding</p>  <p>ICM8</p> <p><i>Sold in 8 Foot Lengths</i></p>	<p>Outside Corner Molding</p>  <p>OCM8</p> <p><i>Sold in 8 Foot Lengths</i></p>
<p>Mirror Trim Molding</p>  <p>MT8</p> <p><i>Sold in 8 Foot Lengths</i></p>	<p>Shoe Molding</p>  <p>SHOE8</p> <p><i>Sold in 8 Foot Lengths</i></p>
<p>Light Valance Shaker Molding</p>  <p>LVSH8</p> <p><i>Sold in 8 Foot Lengths</i></p>	<p>Valance</p>  <p>V4M</p> <p><i>Sold in 8 Foot Lengths</i></p>
<p>Toe Kick Covers</p>  <p>TKC8</p> <p><i>Sold in 8 Foot Lengths</i></p>	<p>Furniture Toe Kick</p>  <p>FTK8</p> <p><i>Sold in 8 Foot Lengths</i></p>
<p>Toe Kick End</p>  <p>TKE</p> <p><i>Sold in 8 Foot Lengths</i></p>	<p>Light Valance Molding</p>  <p>LVM8</p> <p><i>Sold in 8 Foot Lengths</i></p>
<p>Custom Shelf Kit</p>  <p>CSK96</p> <p><i>Sold in 8 Foot Lengths</i></p>	<p>Floating Shelves</p>  <p>FLSH18 FLSH21 FLSH24 FLSH27 FLSH30 FLSH33 FLSH36 FLSH42 FLSH48 FLSH54 FLSH60 FLSH66 FLSH72</p> <p>Maximum weight 50 lbs Approximately 4"-6" spacing perpendicular support</p>

Molding and Decorative Accessories

Decorative Accessories-Legs/Posts

Pilaster Leg "Shaker"

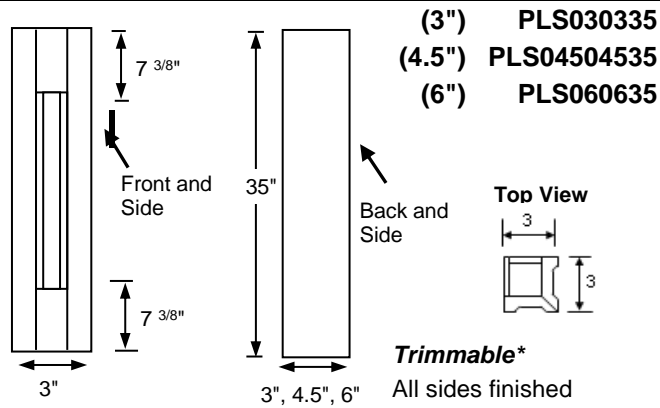

Hour Glass Leg



P82-5

Trimmable*

Straight Leg

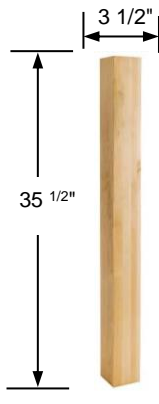

P42

Trimmable*

Tapered Leg

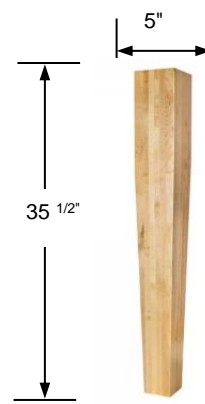

P42-5

Trimmable*

P43-5

Trimmable*

Pilaster Farm Leg

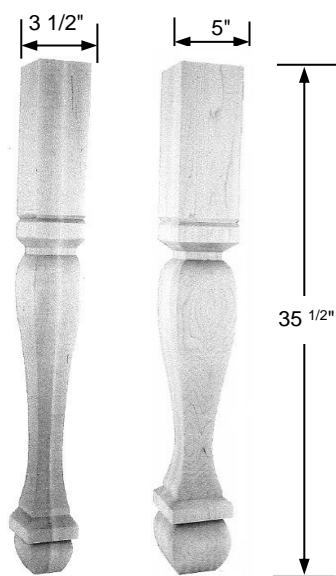

P13-3.5
P13-5

Trimmable*

Pilasters

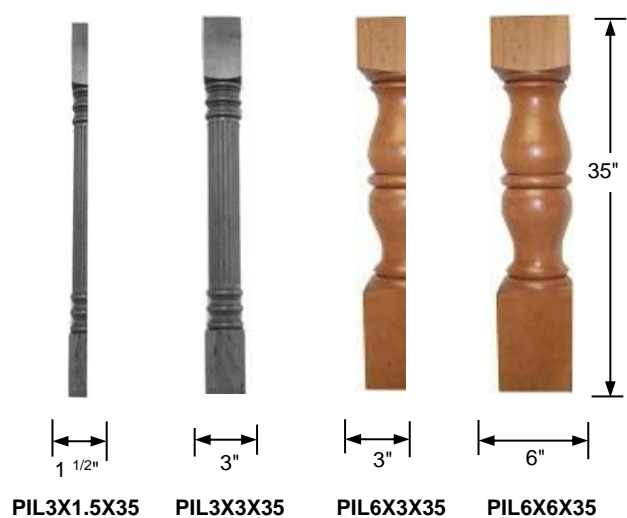

Trimmable*

Molding and Decorative Accessories

Decorative Accessories-Miscellaneous

Plate Covers

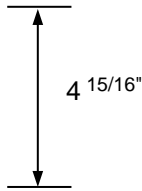
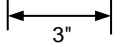

PLATE-OUTLET

PLATE-ROCKER

Decorative Accessories-Corbels and Brackets

Counterbalance Bracket

Corbel - Shaker

CBPL0412

CS0509

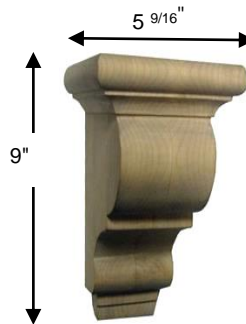
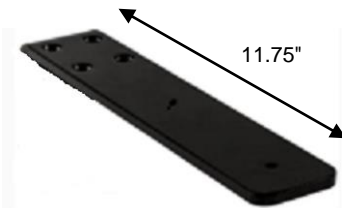

Dimensions: 5 9/16" wide x 9" high x 6" deep

"L" Bracket - Shaker

LBS12



Dimensions: 3" wide x 12" high x 6 1/2" deep

Molding and Decorative Accessories

Decorative Accessories-Arched Valances

Arched Valance 10" TALL

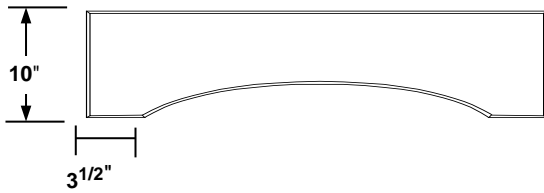

Center Height	
AV3010	7"
AV3610 - AV7210	5"

AV3010
AV3610
AV4210
AV4810
AV5410
AV6010
AV6610
AV7210

***Valance Cannot Be Trimmed

Arched Valance- "Shaker" 8" TALL

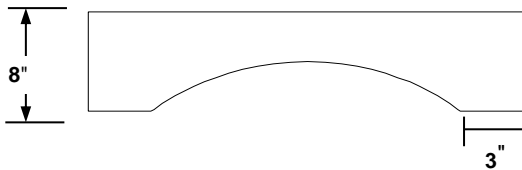

Center Height	
AVS4808 - AVS6608	7"

AVS4208
AVS4808
AVS5408
AVS6008
AVS6608

***Valance is Trimmable

* Note: This valance to be used with PCCS034818

Arched Valance- "Shaker" 10" TALL

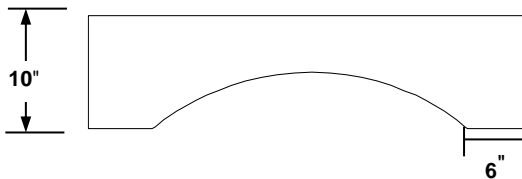

Center Height	
AVS3010	7"
AVS3610 - AVS7210	5"

AVS3010
AVS3610
AVS4210
AVS4810
AVS5410
AVS6010
AVS6610
AVS7210

***Valance is Trimmable

Arched Radius Decorative Valance

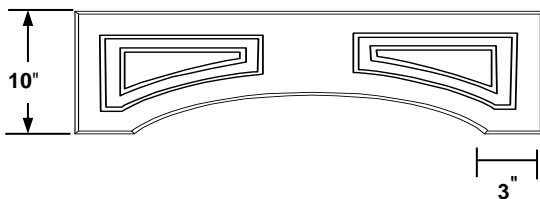

Center Height	
ARDV3010	7"
ARDV3610	7"
ARDV4210 - ARDV7210	7 7/16"

ARDV3010
ARDV3610
ARDV4210
ARDV4810
ARDV5410
ARDV6010
ARDV6610
ARDV7210

*Must be installed between cabinets, edges must be concealed

***Valance Cannot Be Trimmed

Straight Valance

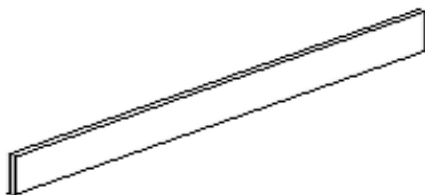

* Finished on all edges, front & back

SV3608
SV4808
SV6008
SV7208

Tapered Foot



BTF0304

Molding and Decorative Accessories

Decorative Accessories-Mantels

Mantels

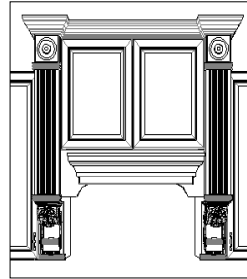
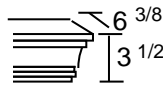
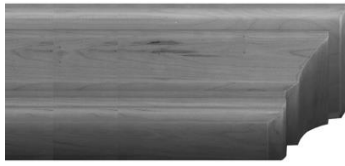

- MANTEL27
- MANTEL30
- MANTEL33
- MANTEL39
- MANTEL45
- MANTEL51
- MANTEL57
- MANTEL60
- MANTEL69

Mantels should only be used with an Arched Valance "AV"

Mantels- "Shaker"



- MS29
- MS35
- MS41
- MS47
- MS53
- MS59
- MS65
- MS71

Shaker Mantels should be used with an Arch Valance Shaker "AVS".

Can be used with either 8" or 10" AVS

Toe Kick Covers - Arched



- TKCA12
- TKCA15
- TKCA18
- TKCA21
- TKCA24
- TKCA27
- TKCA30
- TKCA33
- TKCA36
- TKCA42
- TKCA48
- TKCA54
- TKCA60
- TKCA66
- TKCA72

Modular Decorative Items

- *Index*
- *Bridges & Posts*
- *Columns*
- *Column Corbel Shakers*
- *Grottos*
- *Pilaster Columns*
- *Pilasters*
- *Island Tables*

Modular Decorative Items

Page Location	Item Type	Nomenclature
125-126 127	Column with Shaker Detail Shaker Pilasters	PCCS PS / PES

Modular Decorative Items

3" & 6"x48" & 36" Column Corbel Shaker - 18" Depth

3" & 6"x48" & 36" Column Corbel Shaker - 24" Depth

PCCS063618L
 PCCS063618R
 PCCS064818L
 PCCS064818R

PCCS063624L
 PCCS063624R
 PCCS064824L
 PCCS064824R

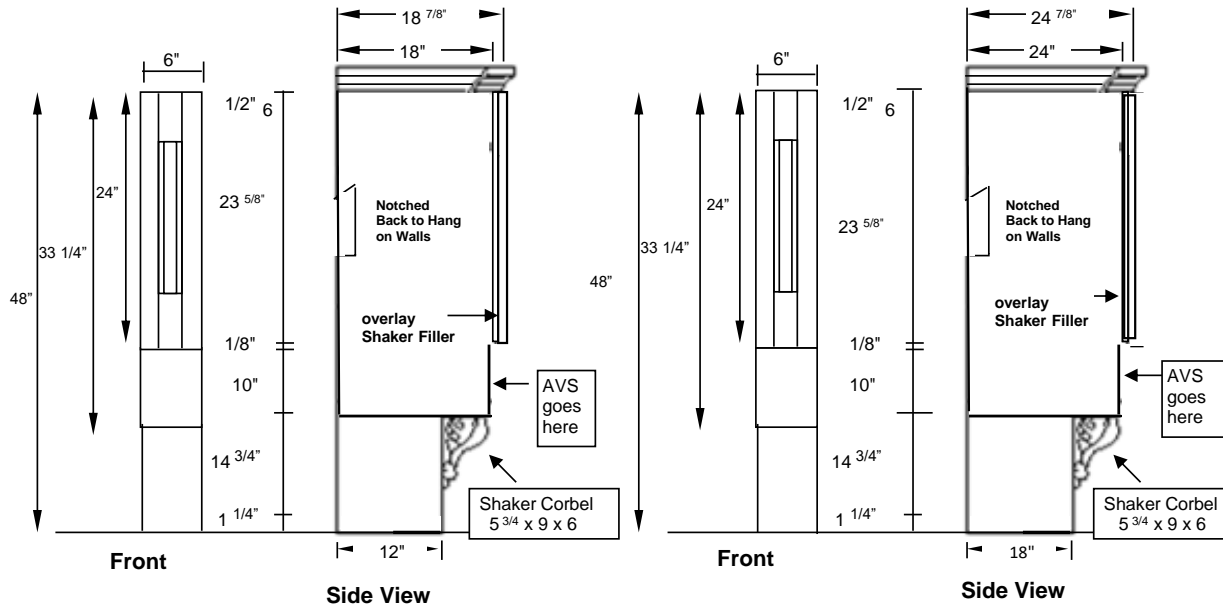

FRONT VIEW OF PCCS064818L/R OR PCCS064824L/R WITH DRFFS AND VALANCE

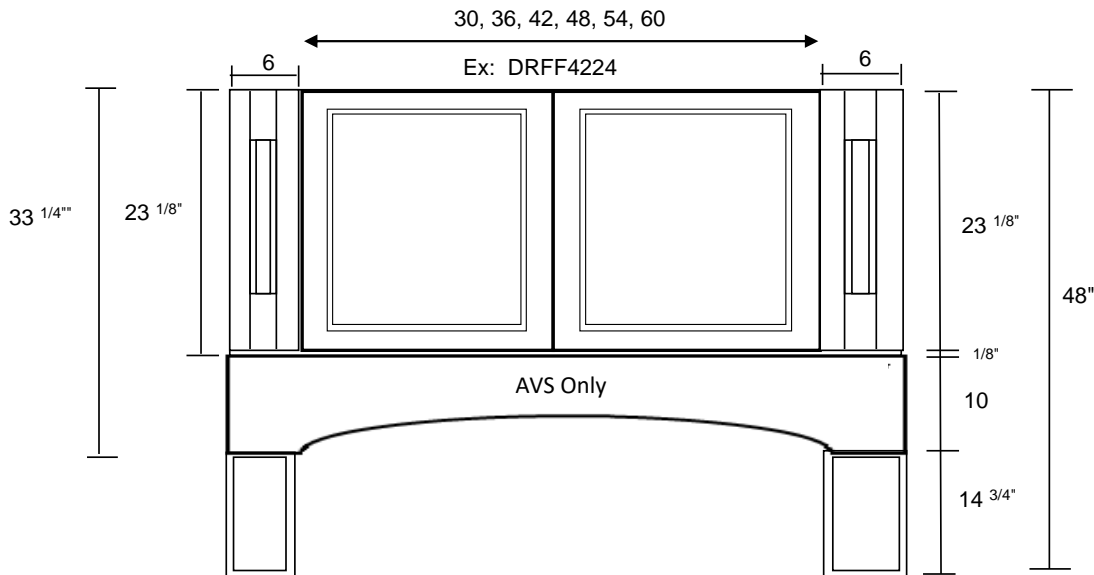

Note: The front frame is 24" high and the Arch Valance runs across both columns and is set 1/8" below DRFF and overlay fillers

Modular Decorative Items

3"x48" Column Corbel Shaker - 18" Depth

PCCS034818L
PCCS034818R

3" x48" Column Corbel Shaker - 24" Depth

PCCS034824L
PCCS034824R

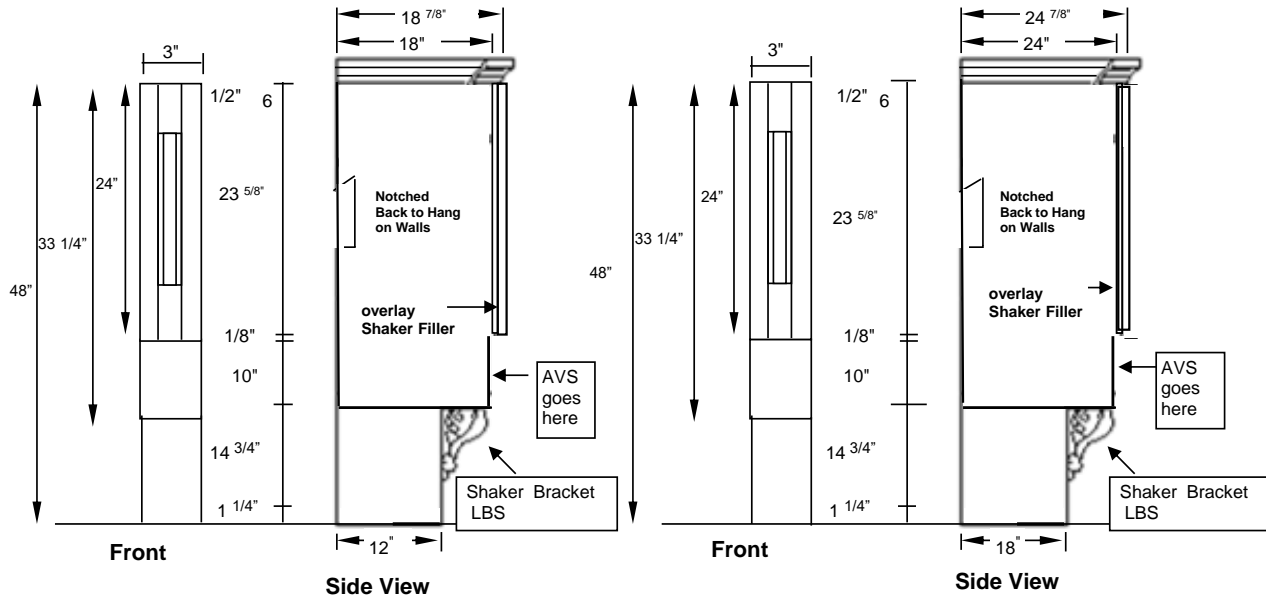

FRONT VIEW OF PCCS034818L/R OR PCCS034824L/R WITH DRFFS AND VALANCE

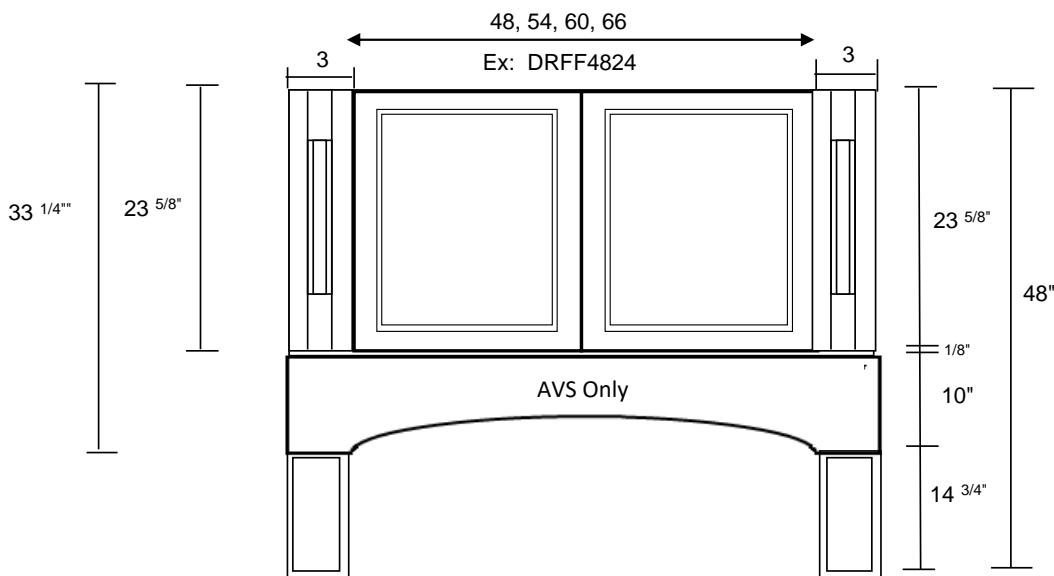

NOTE - If you change the column height from 48" to:

42" Use an 18"h. DRFF

39" Use a 15"h. DRFF

Note: The front frame is 24" high and the Arch Valance runs across both columns and is set 1/8" below DRFF and overlay fillers

Notch (14 3/4") and Valance (10") Can Not Be Changed

Modular Decorative Items

PS Pilaster "Shaker" Single Sided

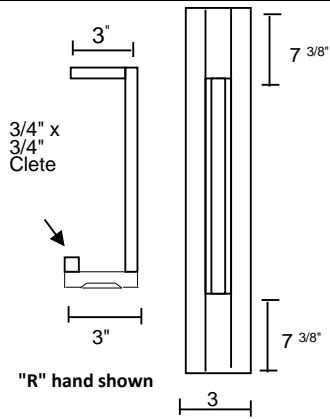

"R" hand shown

Box not Finished on top or bottom

- Actual Heights:
 30 = 30 9/16
 36 = 36
 42 = 41 7/8
 48 = 48
 54 = 54
 60 = 60
 84 = 84
 90 = 90
 96 = 96
 102 = 102

Base (24 7/8" Deep)

PS033524L/R

Wall- (12 7/8" Deep)

PS033012L/R

PS033612L/R

PS034212L/R

PS034812L/R

PS035412L/R

PS036012L/R

Wall- 15 7/8" Deep

PS034815L/R

PS035415L/R

PS036015L/R

Tall- (12 7/8" Deep)

PS038412L/R

PS039012L/R

PS039612L/R

PS0310212L/R

Tall- (24 7/8" Deep)

PS038424L/R

PS039024L/R

PS039624L/R

PS0310224L/R

PS Pilaster "Shaker" Double Sided

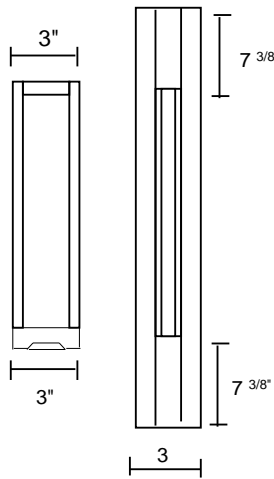

Box not Finished on top or bottom

- Actual Heights:
 30 = 30 9/16
 36 = 36
 42 = 41 7/8
 48 = 48
 54 = 54
 60 = 60
 84 = 84
 90 = 90
 96 = 96
 102 = 102

Base (24 7/8" Deep)

PS033524

Wall- (12 7/8" Deep)

PS033012

PS033612

PS034212

PS034812

PS035412

PS036012

PS033621-W

Finished on Bottom

PS034224-W

PS034824-W

PS035424-W

Wall- 15 7/8" Deep

PS034815

PS035415

PS036015

Tall- (12 7/8" Deep)

PS038412

PS039012

PS039612

PS0310212

Tall- (24 7/8" Deep)

PS038424

PS039024

PS039624

PS0310224

TAB: Replacement Items

Replacement Items

- ***Index***
- ***Miscellaneous Items***
- ***Sample Doors***
- ***Color Blocks***
- ***Door Drilling Information***
- ***Gatehouse***
 - *Doors & Drawer Heads*
 - *Glass & Mullion Doors*
 - *Drawers & Pullouts*
 - *Shelving*
- ***Carriage House***
 - *Doors & Drawer Heads*
 - *Glass & Mullion Doors*
 - *Drawers & Pullouts*
 - *Shelving*
 - *Veneer Shelving*

Replacement Items

Page Location	Item Type	Nomenclature
131	1 Color Block Sample Box	BLOCK BOX
131	1 Color Block Sample	COLOR BLOCK
130	1 Pair Scissor Hinges	TOT-HINGE
130	11" Tray	TOT11
130	14" Tray	TOT14
130	All Gatehouse Color Block Samples	GHS COLOR SET
130	Bumper Pads	BUMPER PAD
141	Carriage House 12" / 15" / 24" Shelves	SH / SHDF
142	Carriage House Custom Shelf Kit	CSK
138	Carriage House Doors	DR
138	Carriage House Drawer Heads	DH / DHF
140	Carriage House Drawer Kits	RDK
141	Carriage House Full Depth Shelves	FDSK
139	Carriage House Glass / Mullion Doors	DRG / DRM
142	Carriage House Glass Shelves	GSK
141	Carriage House Pantry Shelf Kits	PSK
140-141	Carriage House Pullout Tray Kits	POTC / POKT
140	Carriage House Pullouts	RPK
141	Carriage House Shelf Hardware	SHELF PINS
140	Carriage House Spice Pullouts	SPICE RACK
140	Carriage House Trash Can	TRASH CAN
142-143	Carriage House Veneer Shelves	VSH / VSHFW / VSHDF
142	Carriage House Veneer Wall Corner Shelves	VSHWC / VSHWDFC
141	Carriage House Wall Corner Shelves	WCSH / WDFCSH
130	Complete Touch Up Kit (CHS Stains Only)	CARE-KIT
130	Touch Up Stick	TU-STICK
130	Touch Up Bottle	TU-BOTTLE
130	Touch Up Marker	TU-MARKER
130	Door Display Rack	DISPLAY RACK
130	Drawer Head Screws	DRWR HD SCREW
131	Full Lines Color Block Samples	COLORS ALL
136	Gatehouse 12" / 15" / 24" Shelves	SH / SHDF
133	Gatehouse Doors	DR
133	Gatehouse Drawer Heads	DH
135	Gatehouse Drawer Kits	RDK
136	Gatehouse Full Depth Shelves	FDSK
134	Gatehouse Glass/Mullion Doors	DRG / DRM
136	Gatehouse Pantry Shelf Kits	PSK
135	Gatehouse Pullout Tray Kits	POT / POTC / POKT
135	Gatehouse Pullouts	RPK
136	Gatehouse Shelf Hardware	SHELF PINS
135	Gatehouse Spice Pullouts	SPICE RACK
136	Gatehouse Trash Can	TRASH CAN
137	Gatehouse Veneer Shelves	VSH / VSHDF
137	Gatehouse Veneer Wall Corner Shelves	VSHWC / VSHWDFC
136	Gatehouse Wall Corner Shelves	WCSH / WDFCSH
130	Installation Screw - Long 3"	LONG SCREW
130	Installation Screw - Short 1 5/8"	SHORT SCREW
130	Machine Screw 1"	MS100
130	Machine Screw 1 5/8"	MS158
130	Machine Screw 1 7/8"	MS237
130	Plastic Caps	PLASTIC CAP
130	Sample Door 15" x 18" No Drilling	SAMPLE DOOR
130	Strike Catch	STRIKE CATCH
130	Non-Soft Close Hinge (GHS)	HINGE
130	Soft Close Hinge (CHS)	HINGE-SC
130	Utility w/ RO & BLS Non-Soft Close Hinge	HINGE-UCR
130	Utility w/ RO Soft-Close Hinge	HINGE-UCR-SC
130	Utility w/ SH Non-Soft Close Hinge	HINGE-UCS
130	Utility w/ SH Soft-Close Hinge	HINGE-UCS-SC
130	21D 3/4 Ext Sidemount Glides	SMG21
130	18D 3/4 Ext Sidemount Glides	SMG18
130	21D Base Trash Can Glides	SMG21-BTC
130	21D Full Ext Undermount Glides	UMG21-FX-SC
130	18D Full Ext Undermount Glides	UMG18-FX-SC
130	Standard & Upgrade Hardware Board	BOARD STD 2019, BOARD UPG 2019
140	Pullouts with Canisters	PO-CANS

Replacement Items

Miscellaneous Items

Code	Description
MS100	Machine Screw 1"
MS158	Machine Screw 1 5/8"
MS175	Machine Screw 1 7/8"
SHORT SCREWS	Installation Screw - Short 1 5/8"
LONG SCREWS	Installation Screw - Long 3"
DRWR HD SCREW	Drawer Head Screws
STRIKE CATCH	Strike Catch
PLASTIC CAP	Plastic Caps
BUMPER PAD	Bumper Pads (200 per sheet)

Salesperson's Sample Items	
BOARDSTD2019	Standard Hardware Board
BOARDUPG2019	Upgrade Hardware Board
SAMPLE DOOR	Sample Door 15 x 18 No Drilling
DISPLAY RACK	Door Display Rack (Holds 15 Doors)
TU-STICK	Touch Up Stick
TU-BOTTLE	Touch Up Bottle
TU-MARKER	Touch Up Marker
CARE-KIT	Complete Touch Up Kit (ALL COLORS)

Individual Tilt Out Trays			
MFG Code	Style Code	Item Code	Description
HWD	XX	TOT11	11" Tray
HWD	XX	TOT14	14" Tray
HWD	XX	TOT-HINGE	1 Pair Scissor Hinges

Factory Installed Tilt Out Trays		
	# of Trays Installed	
	TOT11	TOT14
SB18	1	
SB24		1
SB27		1
SB30	2	
SB33	2	
SB36		2
SB39	2	
SB42		2
SB48 (on 18")	1	
SBB45	2	
SBB48	2	
SBB54		2
SBD45	2	
SBD48	2	
SBD54		2
SBTC45	2	
SBTC48	2	
SBTC54		2
SFD36	1	
SFD42		1

MFG Reason Code: TOT

MFG Code	Style Code	Item Code	Description
GHS	XX	CHARGE	CHARGE LINE
CHS	XX	CHARGE	CHARGE LINE

* Enter as a Manual Order line item - key in the price - customer discount does not apply

MFG Code	Style Code	Item Code	Description
DEL	XX	CHARGE	DELIVERY CHARGE

* The delivery code above is a manual line item that user keys into order. You may enter any price you need, customer discount does not apply. Use the Price Code "NS" in the PC code field in your order detail.

Hinge and Glides		
HWD	HINGE	Non-Soft Close Hinge (GHS)
HWD	HINGE-SC	Soft Close Hinge (CHS)
HWD	HINGE-UCR	Utility w/ RO & BLS Non-Soft Close Hinge
HWD	HINGE-UCR-SC	Utility w/ RO Soft-Close Hinge
HWD	HINGE-UCS	Utility w/ SH Non-Soft Close Hinge
HWD	HINGE-UCS-SC	Utility w/ SH Soft-Close Hinge
HWD	SMG21	21D 3/4 Ext Sidemount Glides
HWD	SMG18	18D 3/4 Ext Sidemount Glides
HWD	SMG21-BTC	21D Base Trash Can Glides
HWD	UMG21-FX-SC	21D Full Ext Undermount Glides
HWD	UMG18-FX-SC	18D Full Ext Undermount Glides
HWD	UMG-CLIPS	Undermount Glid Clip
HWD	UMG-SOCKETS	Undermount Glid Socket

Undermount Glid Socket

Replacement Items

Approved Sample Door List
Item Code: SAMPLE DOOR

Gatehouse Sample Doors

ORDER ON DEMAND SDW1518

Carriage House Sample Doors

ORDER ON DEMAND SDW1518

Color Block Information

Code	Description
CHS NM COLOR BLOCK	1 COLOR BLOCK SAMPLE
CHS NM BLOCK BOX	1 COLOR BLOCK SAMPLE BOX
GHS NM COLOR SET	ALL GHS COLOR BLOCK SAMPLES 1 BLOCK BOX IS INCLUDED
CHS NM COLORS ALL	FULL LINES COLOR BLOCK SAMPLES 1 BLOCK BOXES ARE INCLUDED

GHS COLOR SET INCLUDES

MAPLE	CHERRY	PAINT
AUBURN MAPLE ESPRESSO MAPLE SAND MAPLE WALNUT MAPLE		GRAY WHITE WILLOW

COLORS ALL INCLUDES

MAPLE	CHERRY	PAINT
AUBURN MAPLE ESPRESSO MAPLE PEWTER MAPLE SAND MAPLE WALNUT MAPLE	AUBURN CHERRY WALNUT CHERRY WALNUT BLACK DISTRESSED	ARCTIC ARCTIC BLACK BLACK BLACK DISTRESSED BLUE GRAY SILVER STONE WHITE WILLOW VERDE

* Please allow the standard 4 week lead time when ordering COLOR SETS

* Lead time for smaller orders of individual COLOR BLOCKS will be handled on a case by case basis

Replacement Items

Door Hinge Drilling Information for GHS and CHS

When ordering replacement doors, it is important to know the following:

1. All doors up to 36" high receive 2 hinge drillings.
 2. All GHS and CHS doors 42" high receive 3 hinge drillings; except angled, glass and mullion doors which receive 2 hinge drillings.
 3. All angled, glass and mullion doors receive 2 hinge drillings.
 4. All 48", 54" and 61" high doors receive 3 hinge drillings.
 5. Hinges do not come with the doors - if needed, they must be ordered separately as REPLACEMENT ITEM.
- ** Be sure to specify the type of cabinet and manufacturer in REPLACEMENT ITEM detail screen to ensure you receive the correct hinges!! ***

Replacement Items

Doors & Drawer Heads Gatehouse Series "GHS"

	Door Code	Width	Height	
12	DR1212	11 ^{17/25}	10 ^{27/32}	
	DR1512	14 ^{11/16}	10 ^{27/32}	
	DR1612	16 ^{3/16}	10 ^{27/32}	
	DR1812	17 ^{11/16}	10 ^{27/32}	
	DR1912	19 ^{3/16}	10 ^{27/32}	
	DR2112	20 ^{11/16}	10 ^{27/32}	
15	DR1515	14 ^{11/16}	13 ^{27/32}	
	DR1615	16 ^{3/16}	13 ^{27/32}	
	DR1815	17 ^{11/16}	13 ^{27/32}	
	DR1915	19 ^{3/16}	13 ^{27/32}	
	DR0918	8 ^{11/16}	16 ^{27/32}	
18	DR1118	11 ^{1/8}	16 ^{27/32}	
	DR1218	11 ^{11/16}	16 ^{27/32}	
	DR1318	13 ^{3/16}	16 ^{27/32}	
	DR1518	14 ^{11/16}	16 ^{27/32}	
	DR1618	16 ^{3/16}	16 ^{27/32}	
	DR1818	17 ^{11/16}	16 ^{27/32}	
	DR1918	19 ^{3/16}	16 ^{27/32}	
	DR2118	20 ^{11/16}	16 ^{27/32}	
	DR2418	23 ^{11/16}	16 ^{27/32}	
	21	DR1821	17 ^{11/16}	19 ^{18/25}
	24	DR1224	11 ^{11/16}	22 ^{15/32}
		DR1324	13 ^{3/16}	22 ^{15/32}
DR1524		14 ^{11/16}	22 ^{15/32}	
DR1624		16 ^{3/16}	22 ^{15/32}	
DR1824		17 ^{11/16}	22 ^{15/32}	
DR1924		19 ^{3/16}	22 ^{15/32}	
DR2124		20 ^{11/16}	22 ^{15/32}	
DR2424		23 ^{14/25}	22 ^{15/32}	
25	DR2125	20 ^{11/16}	23 ^{15/32}	
28	DR1528.5	14 ^{11/16}	27 ^{13/32}	
	DR1828.5	17 ^{11/16}	27 ^{13/32}	
30	DR0630	5 ^{11/16}	29 ^{13/32}	
	DR0830	8 ^{1/8}	29 ^{13/32}	
	DR0930	8 ^{11/16}	29 ^{13/32}	
	DR1130	11 ^{1/8}	29 ^{13/32}	
	DR1230	11 ^{11/16}	29 ^{13/32}	
	DR1330	13 ^{3/16}	29 ^{13/32}	
	DR1530	14 ^{11/16}	29 ^{13/32}	
	DR1630	16 ^{3/16}	29 ^{13/32}	
	DR1830	17 ^{11/16}	29 ^{13/32}	
	DR2130	20 ^{11/16}	29 ^{13/32}	
	DR2430	23 ^{11/16}	29 ^{13/32}	
	36	DR0636	5 ^{11/16}	34 ^{27/32}
		DR0936	8 ^{11/16}	34 ^{27/32}
		DR1136	11 ^{1/8}	34 ^{27/32}
DR1236		11 ^{11/16}	34 ^{27/32}	
DR1336		13 ^{3/16}	34 ^{27/32}	
DR1536		14 ^{11/16}	34 ^{27/32}	
DR1636		16 ^{3/16}	34 ^{27/32}	
DR1836		17 ^{11/16}	34 ^{27/32}	
DR2136		20 ^{11/16}	34 ^{27/32}	
DR2436		23 ^{11/16}	34 ^{27/32}	
42		DR0642	5 ^{11/16}	40 ^{23/32}
	DR0942	8 ^{11/16}	40 ^{23/32}	
	DR1142	11 ^{1/8}	40 ^{23/32}	
	DR1242	11 ^{11/16}	40 ^{23/32}	
	DR1342	13 ^{3/16}	40 ^{23/32}	
	DR1542	14 ^{11/16}	40 ^{23/32}	
	DR1642	16 ^{3/16}	40 ^{23/32}	
	DR1842	17 ^{11/16}	40 ^{23/32}	
	DR2142	20 ^{11/16}	40 ^{23/32}	
	DR2442	23 ^{11/16}	40 ^{23/32}	

	Door Code	Width	Height
48	DR2448	23 ^{11/16}	46 ^{13/16}
	DR1548-WD	14 ^{11/16}	45 ^{9/16}
	DR1848-WD	17 ^{11/16}	45 ^{9/16}
	DR1848-VLC	17 ^{11/16}	44 ^{13/16}
54	DR1554-WD	14 ^{11/16}	51 ^{7/16}
	DR1854-WD	17 ^{11/16}	51 ^{7/16}
61	DR1261	11 ^{11/16}	61 ^{7/32}
	DR1561	14 ^{11/16}	61 ^{7/32}
	DR1861	17 ^{11/16}	61 ^{7/32}
	DR2461	23 ^{11/16}	61 ^{7/32}

	Drawer Head Code	Width	Height
5	DH1505	14 ^{11/16}	4 ^{23/32}
	DH1805	17 ^{11/16}	4 ^{23/32}
	DH2405	23 ^{13/32}	4 ^{23/32}
	DH3005	29 ^{13/32}	4 ^{23/32}
	DH3605	35 ^{13/32}	4 ^{23/32}
6	DH1206	11 ^{11/16}	6 ^{5/8}
	DH1506	14 ^{11/16}	6 ^{5/8}
	DH1806	17 ^{11/16}	6 ^{5/8}
	DH2106	20 ^{11/16}	6 ^{5/8}
	DH2406	23 ^{13/32}	6 ^{5/8}
	DH2706	26 ^{13/32}	6 ^{5/8}
	DH3006	29 ^{13/32}	6 ^{5/8}
9	DH3306	32 ^{13/32}	6 ^{5/8}
	DH3606	35 ^{13/32}	6 ^{5/8}
	DH3906	38 ^{13/32}	6 ^{5/8}
	DH1209	11 ^{11/16}	9
	DH1509	17 ^{7/8}	9
11	DH1809	11 ^{7/8}	9
	DH2109	14 ^{7/8}	9
	DH2409	17 ^{7/8}	9
12	DH1211	11 ^{11/16}	10 ^{27/32}
	DH1511	14 ^{11/16}	10 ^{27/32}
	DH1811	17 ^{11/16}	10 ^{27/32}
	DH2111	20 ^{11/16}	10 ^{27/32}
	DH2411	23 ^{13/32}	10 ^{27/32}
	DH2711	26 ^{13/32}	10 ^{27/32}
	DH3011	29 ^{13/32}	10 ^{27/32}
	DH3311	32 ^{13/32}	10 ^{27/32}
15	DH3611	35 ^{13/32}	10 ^{27/32}
	DH1512	14 ^{11/16}	12 ^{1/2}
15	DH1812	17 ^{11/16}	12 ^{1/2}
	DH2415	24 ^{13/32}	15
15	DH2715	26 ^{13/32}	15
	DH3015	29 ^{13/32}	15
	DH3315	32 ^{13/32}	15
	DH3615	35 ^{13/32}	15

Replacement Items

Glass/Mullion Doors Gatehouse Series "GHS"

	Glass Door Code	Width	Height
15	DRG1515	14 ^{11/16}	13 ^{27/32}
	DRG1815	17 ^{11/16}	13 ^{27/32}
18	DRG0918	8 ^{11/16}	16 ^{27/32}
	DRG1118	10 ^{11/16}	16 ^{27/32}
	DRG1218	11 ^{11/16}	16 ^{27/32}
	DRG1318	13 ^{3/16}	16 ^{27/32}
	DRG1518	14 ^{11/16}	16 ^{27/32}
	DRG1618	16 ^{3/16}	16 ^{27/32}
	DRG1818	17 ^{11/16}	16 ^{27/32}
24	DRG2118	20 ^{11/16}	16 ^{27/32}
	DRG1524	14 ^{11/16}	22 ^{15/32}
30	DRG1824	16 ^{3/16}	22 ^{15/32}
	DRG1330	13 ^{3/16}	29 ^{13/32}
	DRG1530	14 ^{11/16}	29 ^{13/32}
	DRG1630	16 ^{3/16}	29 ^{13/32}
	DRG1830	17 ^{11/16}	29 ^{13/32}
36	DRG2130	20 ^{11/16}	29 ^{13/32}
	DRG1336	13 ^{3/16}	34 ^{27/32}
	DRG1536	14 ^{11/16}	34 ^{27/32}
	DRG1636	16 ^{3/16}	34 ^{27/32}
	DRG1836	17 ^{11/16}	34 ^{27/32}
42	DRG2136	20 ^{11/16}	34 ^{27/32}
	DRG1342	13 ^{3/16}	40 ^{23/32}
	DRG1542	14 ^{11/16}	40 ^{23/32}
	DRG1642	16 ^{3/16}	40 ^{23/32}
	DRG1842	17 ^{11/16}	40 ^{23/32}
48	DRG2142	20 ^{11/16}	40 ^{23/32}
	DRG1348	13 ^{3/16}	46 ^{13/16}
	DRG1548	14 ^{11/16}	46 ^{13/16}
	DRG1548-WD	16 ^{3/16}	45 ^{23/32}
54	DRG1848-WD	17 ^{11/16}	45 ^{23/32}
	DRG1554-WD	14 ^{11/16}	51 ^{7/16}
	DRG1854-WD	17 ^{11/16}	51 ^{7/16}

	Mullion Door Code	Width	Height
18	DRM0918	8 ^{11/16}	16 ^{27/32}
	DRM1218	11 ^{11/16}	16 ^{27/32}
	DRM1318	13 ^{3/16}	16 ^{27/32}
	DRM1518	14 ^{11/16}	16 ^{27/32}
	DRM1618	16 ^{3/16}	16 ^{27/32}
	DRM1818	17 ^{11/16}	16 ^{27/32}
	DRM2118	20 ^{11/16}	16 ^{27/32}
24	DRM1524	14 ^{11/16}	22 ^{15/32}
	DRM1824	17 ^{11/16}	22 ^{15/32}
30	DRM1330	12 ^{11/16}	29 ^{13/32}
	DRM1530	14 ^{11/16}	29 ^{13/32}
	DRM1630	16 ^{3/16}	29 ^{13/32}
	DRM1830	17 ^{11/16}	29 ^{13/32}
36	DRM2130	20 ^{11/16}	29 ^{13/32}
	DRM1336	12 ^{11/16}	34 ^{27/32}
	DRM1536	14 ^{11/16}	34 ^{27/32}
	DRM1636	16 ^{3/16}	34 ^{27/32}
42	DRM1836	17 ^{11/16}	34 ^{27/32}
	DRM2136	20 ^{11/16}	34 ^{27/32}
	DRM1342	12 ^{11/16}	40 ^{23/32}
	DRM1542	14 ^{11/16}	40 ^{23/32}
48	DRM1642	16 ^{3/16}	40 ^{23/32}
	DRM1842	17 ^{11/16}	40 ^{23/32}
	DRM2142	20 ^{11/16}	40 ^{23/32}
	DRM1548	14 ^{11/16}	46 ^{13/16}
54	DRM1548-WD	14 ^{11/16}	45 ^{23/32}
	DRM1848-WD	17 ^{11/16}	45 ^{23/32}
54	DRM1554-WD	14 ^{11/16}	51 ^{7/16}
	DRM1854-WD	17 ^{11/16}	51 ^{7/16}

Replacement Items

Gatehouse Drawer Cores & Pullouts

* Note: Replacement Drawer Kits "RDK" and "POT" Kits come with inner and outer glide sets

Base Drawer	Width	Depth	Height
RDK1221	12" Base Drawer	9 ^{11/16}	21 3
RDK1521	15" Base Drawer	12 ^{11/16}	21 3
RDK1821	18" Base Drawer	15 ^{11/16}	21 3
RDK2121	21" Base Drawer	18 ^{11/16}	21 3
RDK2421	24" Base Drawer	21 ^{11/16}	21 3
RDK2721	27" Base Drawer	24 ^{11/16}	21 3
RDK3021	30" Base Drawer	27 ^{11/16}	21 3
RDK3321	33" Base Drawer	30 ^{11/16}	21 3
RDK3621	36" Base Drawer	33 ^{11/16}	21 3

Base Drawer Deep	Width	Depth	Height
RDK1221D	12" Base Deep Drawer	9 ^{11/16}	21 6
RDK1521D	15" Base Deep Drawer	12 ^{11/16}	21 6
RDK1821D	18" Base Deep Drawer	15 ^{11/16}	21 6
RDK2121D	21" Base Deep Drawer	18 ^{11/16}	21 6
RDK2421D	24" Base Deep Drawer	21 ^{11/16}	21 6
RDK2721D	27" Base Deep Drawer	24 ^{11/16}	21 6
RDK3021D	30" Base Deep Drawer	27 ^{11/16}	21 6
RDK3321D	33" Base Deep Drawer	30 ^{11/16}	21 6
RDK3621D	36" Base Deep Drawer	33 ^{11/16}	21 6

Pullouts	Width	Depth	Height
RPK1221	12" Pullout	9 ^{11/16}	21 3 ^{1/4}
RPK1521	15" Pullout	12 ^{11/16}	21 3 ^{1/4}
RPK1821	18" Pullout	15 ^{11/16}	21 3 ^{1/4}
RPK2121	21" Pullout	18 ^{11/16}	21 3 ^{1/4}
RPK2421	24" Pullout	21 ^{11/16}	21 3 ^{1/4}
RPK2721	27" Pullout	24 ^{11/16}	21 3 ^{1/4}
RPK3021	30" Pullout	27 ^{11/16}	21 3 ^{1/4}
RPK3321	33" Pullout	30 ^{11/16}	21 3 ^{1/4}
RPK3621	36" Pullout	33 ^{11/16}	21 3 ^{1/4}

** MFG CODE "GPO" = GATEHOUSE PULLOUT

**Pullout Tray Kits - Tall Cabinets	Width	Depth	Height
POT15	15" Pullout Tray Kit	12 ^{11/16}	21 3 ^{1/4}
POT18	18" Pullout Tray Kit	15 ^{11/16}	21 3 ^{1/4}
POT24	24" Pullout Tray Kit	21 ^{11/16}	21 3 ^{1/4}
POT30	30" Pullout Tray Kit	27 ^{11/16}	21 3 ^{1/4}

Inner and Outer Glide Sets Included - Order in Carriage House

*Spice Pullouts	Width	Depth	Height
SPICE-RACK06	For BPO6 cabinet	4 ^{1/2}	23 ^{3/4} 23 ^{13/16}
SPICE-RACK09	For BPO9 cabinet	6 ^{1/2}	23 ^{3/4} 23 ^{13/16}
SPICE-RACK12	For BPO12 cabinet	9 ^{1/2}	23 ^{3/4} 23 ^{13/16}
SPICE RACK15	For BPO15 cabinet	12 ^{1/2}	23 ^{3/4} 23 ^{13/16}
SPICE RACK18	For BPO18 cabinet	15 ^{1/2}	23 ^{3/4} 23 ^{13/16}

* Comes with inner glides only, cannot upgrade to soft close glides

Desk File Drawers "DF"	Width	Depth	Height
RDK1518-AD	15" DF Top Drawer	12 ^{11/16}	18 3 ^{1/8}
RDK1818-AD	18" DF Top Drawer	15 ^{11/16}	18 3 ^{1/8}

* Comes with inner glides only, cannot upgrade to soft close glides

Apron Drawer "AD"	Width	Depth	Height
RDK1818-AD	18" Apron Drawer	18 ^{11/16}	18 3 ^{1/8}
RDK2418-AD	24" Apron Drawer	21 ^{11/16}	18 3 ^{1/8}
RDK3018-AD	30" Apron Drawer	27 ^{11/16}	18 3 ^{1/8}
RDK3618-AD	36" Apron Drawer	33 ^{11/16}	18 3 ^{1/8}

* Comes with inner glides only, cannot upgrade to soft close glides

Vanity Drawer	Width	Depth	Height
RDK1218	12" Vanity Drawer	9 ^{11/16}	18 3
RDK1518	15" Vanity Drawer	12 ^{11/16}	18 3
RDK1818	18" Vanity Drawer	15 ^{11/16}	18 3
RDK2118	21" Vanity Drawer	18 ^{11/16}	18 3
RDK2418	24" Vanity Drawer	21 ^{11/16}	18 3
RDK2718	27" Vanity Drawer	24 ^{11/16}	18 3
RDK3018	30" Vanity Drawer	27 ^{11/16}	18 3
RDK3318	33" Vanity Drawer	30 ^{11/16}	18 3
RDK3618	36" Vanity Drawer	33 ^{11/16}	18 3

Vanity Drawer Deep	Width	Depth	Height
RDK1218D	12" Vanity Deep Drawer	9 ^{11/16}	18 6
RDK1518D	15" Vanity Deep Drawer	12 ^{11/16}	18 6
RDK1818D	18" Vanity Deep Drawer	15 ^{11/16}	18 6
RDK2118D	21" Vanity Deep Drawer	18 ^{11/16}	18 6
RDK2418D	24" Vanity Deep Drawer	21 ^{11/16}	18 6
RDK2718D	27" Vanity Deep Drawer	24 ^{11/16}	18 6
RDK3018D	30" Vanity Deep Drawer	27 ^{11/16}	18 6
RDK3318D	33" Vanity Deep Drawer	30 ^{11/16}	18 6
RDK3618D	36" Vanity Deep Drawer	33 ^{11/16}	18 6

Pullouts - 21" Deep Base Cabinets	Width	Depth	Height
RPK1218	12" Pullout	9 ^{11/16}	18 3 ^{1/4}
RPK1518	15" Pullout	12 ^{11/16}	18 3 ^{1/4}
RPK1818	18" Pullout	15 ^{11/16}	18 3 ^{1/4}
RPK2118	21" Pullout	18 ^{11/16}	18 3 ^{1/4}
RPK2418	24" Pullout	21 ^{11/16}	18 3 ^{1/4}
RPK2718	27" Pullout	24 ^{11/16}	18 3 ^{1/4}
RPK3018	30" Pullout	27 ^{11/16}	18 3 ^{1/4}
RPK3318	33" Pullout	30 ^{11/16}	18 3 ^{1/4}
RPK3618	36" Pullout	33 ^{11/16}	18 3 ^{1/4}

** MFG CODE "GPO" = GATEHOUSE PULLOUT

*Pullouts- Trash Units	Width	Depth	Height
POTC1522	15" BTC Trash PO	12 ^{9/32}	22 ^{3/16} 4
POTC1822	18" BTC Trash PO	15 ^{9/32}	22 ^{3/16} 4
POTC2122	21" BTC Trash PO	18 ^{9/32}	22 ^{3/16} 4

Inner and Outer Glide Sets Included - Order in Carriage House

Cannot upgrade to soft close glides and trash cans sold separately

Trash Cans	Width	Depth	Height
TRASH-CAN35	35 Qt Trash Can	10 ^{1/2}	17 ^{3/4} 14
TRASH-CAN50	50 Qt Trash Can	10 ^{1/2}	21 ^{3/4} 14

Desk File Deep Drawers "DF" & "DDF"	Width	Depth	Height
RDK1520	15" DF or DDF Bottom Dwr	12 ^{3/4}	20 9 ^{13/16}
RDK1820	18" DF or DDF Bottom Dwr	15 ^{3/4}	20 9 ^{13/16}
RDK2920	29" DF or DDF Bottom Dwr	29 ^{3/4}	20 9 ^{13/16}
RDK3220	32" DF or DDF Bottom Dwr	30 ^{3/4}	20 9 ^{13/16}
RDK3520	35" DF or DDF Bottom Dwr	36 ^{3/4}	20 9 ^{13/16}

* Comes with inner glides only, cannot upgrade to soft close glides

Apron Drawer Keyboard "ADK"	Width	Depth	Height
POKT24	24" ADK Vanity Drwr	20 ^{11/16}	20 3/4
POKT30	30" ADK Vanity Drwr	26 ^{11/16}	20 3/4
POKT36	36" ADK Vanity Drwr	32 ^{11/16}	20 3/4

*Wall Drawers "WD"	Width	Depth	Height
RDK1509	15" Wall Drawer	12 ^{3/8}	10 ^{1/8} 4
RDK1809	18" Wall Drawer	15 ^{3/8}	10 ^{1/8} 4
RDK3009	30" Wall Drawer	27 ^{3/8}	10 ^{1/8} 4
RDK3609	36" Wall Drawer	33 ^{3/8}	10 ^{1/8} 4

Replacement Items

Gatehouse Shelving

* Note: Replacement Shelf Kits come with shelf pins

Wall Shelves - 12" Deep "STD Size"		Width	Depth
SH09	9" Shelf	7 ^{7/16}	10 ^{3/8}
SH12	12" Shelf	10 ^{7/16}	10 ^{3/8}
SH15	15" Shelf	13 ^{7/16}	10 ^{3/8}
SH18	18" Shelf	16 ^{7/16}	10 ^{3/8}
SH21	21" Shelf	19 ^{7/16}	10 ^{3/8}
SH24	24" Shelf	22 ^{7/16}	10 ^{3/8}
SH27	27" Shelf	25 ^{7/16}	10 ^{3/8}
SH30	30" Shelf	28 ^{7/16}	10 ^{3/8}
SH33	33" Shelf	31 ^{7/16}	10 ^{3/8}
SH36	36" Shelf	34 ^{7/16}	10 ^{3/8}
SH39	39" Shelf	37 ^{7/16}	10 ^{3/8}
SH42	42" Shelf	40 ^{7/16}	10 ^{3/8}
SH45	45" Shelf	43 ^{7/16}	10 ^{3/8}
SH48	48" Shelf	46 ^{7/16}	10 ^{3/8}

Wall Shelves - 15" Deep		Width	Depth
SH3015	15" Deep Shelf	28 ^{7/16}	13 ^{3/8}
SH3615	15" Deep Shelf	34 ^{7/16}	13 ^{3/8}

Wall Shelves - 24" Deep		Width	Depth
SH1524	24" Deep Shelf	13 ^{7/16}	23 ^{1/8}
SH1824	24" Deep Shelf	16 ^{7/16}	23 ^{1/8}
SH2424	24" Deep Shelf	22 ^{7/16}	23 ^{1/8}
SH3024	24" Deep Shelf	28 ^{7/16}	23 ^{1/8}
SH3324	24" Deep Shelf	31 ^{7/16}	23 ^{1/8}
SH3624	24" Deep Shelf	34 ^{7/16}	23 ^{1/8}

Wall Corner Shelves		Width	Depth
WCSH24	24" Wall Corner Shelf	22 ^{5/8}	22 ^{5/8}
WCSH27	27" Wall Corner Shelf	25 ^{5/8}	22 ^{5/8}
WPCSH24	24" Wall Pie Cut Corner Shelf	22 ^{7/16}	10 ^{3/8}

Pantry Shelf Kits (12" Deep Utility)		Width	Depth
PSK15	15" Pantry Shelf Kit- 4pk	13 ^{7/16}	10 ^{3/8}
PSK18	18" Pantry Shelf Kit- 4pk	16 ^{7/16}	10 ^{3/8}
PSK24	24" Pantry Shelf Kit- 4pk	22 ^{7/16}	10 ^{3/8}
PSK30	30" Pantry Shelf Kit- 4pk	28 ^{7/16}	10 ^{3/8}

Full Depth Shelf Kits (24" Deep Utility)		Width	Depth
FDSK15	15" Full Depth Shelf Kit- 4pk	13 ^{7/16}	23 ^{1/8}
FDSK18	18" Full Depth Shelf Kit- 4pk	16 ^{7/16}	23 ^{1/8}
FDSK24	24" Full Depth Shelf Kit- 4pk	22 ^{7/16}	23 ^{1/8}
FDSK30	30" Full Depth Shelf Kit- 4pk	28 ^{7/16}	23 ^{1/8}

Shelf Hardware	
SHELF PINS	Standard Wall Shelf Pins (12 per pack)

Wall Shelves - 12" Deep "STD Size" PLYWOOD		Width	Depth
SH09-PLY	9" Shelf	7 ^{7/16}	10 ^{3/8}
SH12-PLY	12" Shelf	10 ^{7/16}	10 ^{3/8}
SH15-PLY	15" Shelf	13 ^{7/16}	10 ^{3/8}
SH18-PLY	18" Shelf	16 ^{7/16}	10 ^{3/8}
SH21-PLY	21" Shelf	19 ^{7/16}	10 ^{3/8}
SH24-PLY	24" Shelf	22 ^{7/16}	10 ^{3/8}
SH27-PLY	27" Shelf	25 ^{7/16}	10 ^{3/8}
SH30-PLY	30" Shelf	28 ^{7/16}	10 ^{3/8}
SH33-PLY	33" Shelf	31 ^{7/16}	10 ^{3/8}
SH36-PLY	36" Shelf	34 ^{7/16}	10 ^{3/8}
SH39-PLY	39" Shelf	37 ^{7/16}	10 ^{3/8}
SH42-PLY	42" Shelf	40 ^{7/16}	10 ^{3/8}
SH45-PLY	45" Shelf	43 ^{7/16}	10 ^{3/8}
SH48-PLY	48" Shelf	46 ^{7/16}	10 ^{3/8}

Wall Shelves - 15" Deep PLYWOOD		Width	Depth
SH3015-PLY	15" Deep Shelf	28 ^{7/16}	13 ^{3/8}
SH3615-PLY	15" Deep Shelf	34 ^{7/16}	13 ^{3/8}

Wall Shelves - 24" Deep PLYWOOD		Width	Depth
SH1524-PLY	24" Deep Shelf	13 ^{7/16}	23 ^{1/8}
SH1824-PLY	24" Deep Shelf	16 ^{7/16}	23 ^{1/8}
SH2424-PLY	24" Deep Shelf	22 ^{7/16}	23 ^{1/8}
SH3024-PLY	24" Deep Shelf	28 ^{7/16}	23 ^{1/8}
SH3324-PLY	24" Deep Shelf	31 ^{7/16}	23 ^{1/8}
SH3624-PLY	24" Deep Shelf	34 ^{7/16}	23 ^{1/8}

Wall Corner Shelves PLYWOOD		Width	Depth
WCSH24-PLY	24" Wall Corner Shelf	22 ^{5/8}	22 ^{5/8}
WCSH27-PLY	27" Wall Corner Shelf	25 ^{5/8}	22 ^{5/8}
WPCSH24-PLY	24" Wall Pie Cut Corner Shelf	22 ^{7/16}	10 ^{3/8}

Wall Corner Shelves PLYWOOD		Width	Depth
WCSH24-PLY	24" Wall Corner Shelf	22 ^{5/8}	22 ^{5/8}
WCSH27-PLY	27" Wall Corner Shelf	25 ^{5/8}	22 ^{5/8}
WPCSH24-PLY	24" Wall Pie Cut Corner Shelf	22 ^{7/16}	10 ^{3/8}

WALL PIE CUT SHELVES PLYWOOD	
WPCSH24-PLY	24 WALL PIE CUT SHELF

Replacement Items

Gatehouse Veneer Shelving for Cabinets with Finished Interiors

Veneer Shelf - Standard Glass and Mullion Cabinets		Width	Depth	Thickness
VSH15	15" Veneer Shelf	13 ^{7/16}	10 ^{3/8}	3/4
VSH18	18" Veneer Shelf	16 ^{7/16}	10 ^{3/8}	3/4
VSH21	21" Veneer Shelf	19 ^{7/16}	10 ^{3/8}	3/4
VSH27	27" Veneer Shelf	25 ^{5/8}	10 ^{3/8}	3/4
VSH30	30" Veneer Shelf	28 ^{7/16}	10 ^{3/8}	3/4
VSH33	33" Veneer Shelf	31 ^{7/16}	10 ^{3/8}	3/4
VSH36	36" Veneer Shelf	34 ^{7/16}	10 ^{3/8}	3/4

Veneer Shelf - 15" Deep - Glass and Mullion Cabinets		Width	Depth	Thickness
VSH1515	15" Veneer Shelf - 15" Deep	13 ^{7/16}	13 ^{3/8}	3/4
VSH1815	18" Veneer Shelf - 15" Deep	16 ^{7/16}	13 ^{3/8}	3/4
VSH3015	30" Veneer Shelf - 15" Deep	28 ^{7/16}	13 ^{3/8}	3/4
VSH3615	36" Veneer Shelf - 15" Deep	34 ^{7/16}	13 ^{3/8}	3/4

Wall Corner Shelves		Width	Depth	Thickness
VSHWC24	24" Veneer WC Shelf	22 ^{5/8}	22 ^{1/2}	3/4
VSHWC27	27" Veneer WC Shelf	25 ^{5/8}	22 ^{1/2}	3/4

Shelf Hardware	
SHELF PINS	Standard Wall Shelf Pins (12 per pack)

PLYWOOD

Veneer Shelf - Standard Glass and Mullion Cabinets		Width	Depth	Thickness
VSH15-PLY	15" Veneer Shelf	13 ^{7/16}	10 ^{3/8}	3/4
VSH18-PLY	18" Veneer Shelf	16 ^{7/16}	10 ^{3/8}	3/4
VSH21-PLY	21" Veneer Shelf	19 ^{7/16}	10 ^{3/8}	3/4
VSH27-PLY	27" Veneer Shelf	25 ^{5/8}	10 ^{3/8}	3/4
VSH30-PLY	30" Veneer Shelf	28 ^{7/16}	10 ^{3/8}	3/4
VSH33-PLY	33" Veneer Shelf	31 ^{7/16}	10 ^{3/8}	3/4
VSH36-PLY	36" Veneer Shelf	34 ^{7/16}	10 ^{3/8}	3/4

Veneer Shelf - 15" Deep - Glass and Mullion Cabinets		Width	Depth	Thickness
VSH1515-PLY	15" Veneer Shelf - 15" Deep	13 ^{7/16}	13 ^{3/8}	3/4
VSH1815-PLY	18" Veneer Shelf - 15" Deep	16 ^{7/16}	13 ^{3/8}	3/4
VSH3015-PLY	30" Veneer Shelf - 15" Deep	28 ^{7/16}	13 ^{3/8}	3/4
VSH3615-PLY	36" Veneer Shelf - 15" Deep	34 ^{7/16}	13 ^{3/8}	3/4

Wall Corner Shelves		Width	Depth	Thickness
VSHWC24-PLY	24" Veneer WC Shelf	22 ^{5/8}	22 ^{1/2}	3/4
VSHWC27-PLY	27" Veneer WC Shelf	25 ^{5/8}	22 ^{1/2}	3/4

Replacement Items

Doors & Drawer Heads Carriage House Series "CHS"

	Door Code	Width	Height	
12	DR1212	11 ^{17/25}	10 ^{21/25}	
	DR1512	14 ^{11/16}	10 ^{21/25}	
	DR1612	16 ^{3/16}	10 ^{21/25}	
	DR1812	17 ^{11/16}	10 ^{21/25}	
	DR1912	19 ^{3/16}	10 ^{21/25}	
	DR2112	20 ^{11/16}	10 ^{21/25}	
15	DR1515	14 ^{11/16}	13 ^{27/32}	
	DR1615	16 ^{3/16}	13 ^{27/32}	
	DR1815	17 ^{11/16}	13 ^{27/32}	
	DR1915	19 ^{3/16}	13 ^{27/32}	
18	DR0918	8 ^{11/16}	16 ^{27/32}	
	DR1118	11 ^{1/8}	16 ^{27/32}	
	DR1218	11 ^{11/16}	16 ^{27/32}	
	DR1318	13 ^{3/16}	16 ^{27/32}	
	DR1518	14 ^{11/16}	16 ^{27/32}	
	DR1618	16 ^{3/16}	16 ^{27/32}	
	DR1818	17 ^{11/16}	16 ^{27/32}	
	DR1918	19 ^{3/16}	16 ^{27/32}	
	DR2118	20 ^{11/16}	16 ^{27/32}	
	DR2418	23 ^{11/16}	16 ^{27/32}	
	DR1818-BLUM	17 ^{11/16}	16 ^{27/32}	
	DR2418-BLUM	23 ^{11/16}	16 ^{27/32}	
	DR3018-BLUM	29 ^{11/16}	16 ^{27/32}	
	DR3618-BLUM	35 ^{11/16}	16 ^{27/32}	
	21	DR1821	17 ^{11/16}	19 ^{18/25}
	24	DR1224	11 ^{11/16}	22 ^{15/32}
DR1324		13 ^{3/16}	22 ^{15/32}	
DR1524		14 ^{11/16}	22 ^{15/32}	
DR1624		16 ^{3/16}	22 ^{15/32}	
DR1824		17 ^{11/16}	22 ^{15/32}	
DR1924		19 ^{3/16}	22 ^{15/32}	
DR2124		20 ^{11/16}	22 ^{15/32}	
DR2424		23 ^{11/16}	22 ^{15/32}	
25	DR2125	20 ^{11/16}	23 ^{15/32}	
28.5	DR1628.5	16 ^{3/16}	27 ^{6/16}	
	DR1828.5	17 ^{11/16}	27 ^{6/16}	
	DR2128.5	20 ^{11/16}	27 ^{6/16}	
30	DR0630	5 ^{11/16}	29 ^{13/32}	
	DR0830	8 ^{1/8}	29 ^{13/32}	
	DR0930	8 ^{11/16}	29 ^{13/32}	
	DR1130	11 ^{1/8}	29 ^{13/32}	
	DR1230	11 ^{11/16}	29 ^{13/32}	
	DR1330	13 ^{3/16}	29 ^{13/32}	
	DR1530	14 ^{11/16}	29 ^{13/32}	
	DR1630	16 ^{3/16}	29 ^{13/32}	
	DR1830	17 ^{11/16}	29 ^{13/32}	
	DR1930	19 ^{3/16}	29 ^{13/32}	
	DR2130	20 ^{11/16}	29 ^{13/32}	
	DR2430	23 ^{11/16}	29 ^{13/32}	
	36	DR0636	5 ^{11/16}	34 ^{27/32}
		DR0936	8 ^{11/16}	34 ^{27/32}
DR1136		11 ^{1/8}	34 ^{27/32}	
DR1236		11 ^{11/16}	34 ^{27/32}	
DR1336		13 ^{3/16}	34 ^{27/32}	
DR1536		14 ^{11/16}	34 ^{27/32}	
DR1636		16 ^{3/16}	34 ^{27/32}	
DR1836		17 ^{11/16}	34 ^{27/32}	
DR1936		19 ^{3/16}	34 ^{27/32}	
DR2136		20 ^{11/16}	34 ^{27/32}	
DR2436		23 ^{14/25}	34 ^{27/32}	
42	DR0642	5 ^{11/16}	40 ^{23/32}	
	DR0942	8 ^{11/16}	40 ^{23/32}	
	DR1142	11 ^{1/8}	40 ^{23/32}	
	DR1242	11 ^{11/16}	40 ^{23/32}	
	DR1342	13 ^{3/16}	40 ^{23/32}	
	DR1542	14 ^{11/16}	40 ^{23/32}	
	DR1642	16 ^{3/16}	40 ^{23/32}	
	DR1842	17 ^{11/16}	40 ^{23/32}	
	DR1942	19 ^{3/16}	40 ^{23/32}	
	DR2142	20 ^{11/16}	40 ^{23/32}	
	DR2442	23 ^{11/16}	40 ^{23/32}	

	Door Code	Width	Height
48	DR1148	11 ^{1/8}	46 ^{13/16}
	DR1248	11 ^{3/4}	46 ^{13/16}
	DR1348	13 ^{3/4}	46 ^{13/16}
	DR1548	14 ^{3/4}	46 ^{13/16}
	DR1648	16 ^{3/4}	46 ^{13/16}
	DR1848	17 ^{3/4}	46 ^{13/16}
	DR2148	20 ^{3/4}	46 ^{13/16}
	DR2448	23 ^{11/16}	46 ^{13/16}
	DR1548-WD	14 ^{11/16}	45 ^{9/16}
	DR1848-WD	17 ^{11/16}	45 ^{9/16}
	DR1848-VLC	17 ^{11/16}	44 ^{13/16}
54	DR1554-WD	14 ^{11/16}	51 ^{7/16}
	DR1854-WD	17 ^{11/16}	51 ^{7/16}
61	DR1261	11 ^{11/16}	61 ^{7/32}
	DR1561	14 ^{11/16}	61 ^{7/32}
	DR1861	17 ^{11/16}	61 ^{7/32}
	DR2461	23 ^{11/16}	61 ^{7/32}

	Drawer Head Code	Width	Height
5	DH1505	14 ^{11/16}	4 ^{23/32}
	DH1805	17 ^{11/16}	4 ^{23/32}
	DH2405	23 ^{13/32}	4 ^{23/32}
	DH3005	29 ^{13/32}	4 ^{23/32}
	DH3305	32 ^{13/32}	4 ^{23/32}
5.5	DH3605	35 ^{13/32}	4 ^{23/32}
	DH1505.5	14 ^{11/16}	5 ^{15/32}
6	DH1805.5	17 ^{11/16}	5 ^{15/32}
	DH1206	11 ^{11/16}	6 ^{7/32}
9	DH1506	14 ^{11/16}	6 ^{7/32}
	DH1806	17 ^{11/16}	6 ^{7/32}
	DH2106	20 ^{11/16}	6 ^{7/32}
	DH2406	23 ^{13/32}	6 ^{7/32}
	DH2706	26 ^{13/32}	6 ^{7/32}
	DH3006	29 ^{13/32}	6 ^{7/32}
	DH3306	32 ^{13/32}	6 ^{7/32}
	DH3606	35 ^{13/32}	6 ^{7/32}
	DH3906	38 ^{13/32}	6 ^{7/32}
	DH1209	11 ^{11/16}	8 ^{3/4}
	DH1509	14 ^{11/16}	8 ^{3/4}
	DH1809	17 ^{11/16}	8 ^{3/4}
	DH2109	20 ^{11/16}	8 ^{3/4}
	DH2409	23 ^{13/32}	8 ^{3/4}
	DH2709	26 ^{13/32}	8 ^{3/4}
	DH3009	29 ^{13/32}	8 ^{3/4}
DH3609	35 ^{13/32}	8 ^{3/4}	
DH4209	40 ^{23/32}	8 ^{3/4}	
DH4809	47 ^{1/2}	8 ^{3/4}	
DH5409	53 ^{1/2}	8 ^{3/4}	
DH6009	59 ^{1/2}	8 ^{3/4}	
DH6609	65 ^{1/2}	8 ^{3/4}	
11	DH1211	11 ^{11/16}	10 ^{27/32}
	DH1511	14 ^{11/16}	10 ^{27/32}
	DH1811	17 ^{11/16}	10 ^{27/32}
	DH2111	20 ^{11/16}	10 ^{27/32}
	DH2411	23 ^{13/32}	10 ^{27/32}
	DH2711	26 ^{13/32}	10 ^{27/32}
	DH3011	29 ^{13/32}	10 ^{27/32}
	DH3311	32 ^{13/32}	10 ^{27/32}
	DH3611	35 ^{13/32}	10 ^{27/32}
	12	DH1512	14 ^{11/16}
DH1812		17 ^{11/16}	12 ^{1/2}
DH3012		29 ^{13/32}	12 ^{1/2}
DH3612		35 ^{13/32}	12 ^{1/2}
15		DH3015	29 ^{13/32}
	DH3315	32 ^{13/32}	14 ^{11/16}
	DH3615	35 ^{13/32}	14 ^{11/16}

DH Backer Panel	
DHBP3609	DH Backer Panel 36x09
DHBP4209	DH Backer Panel 42x09
DHBP4809	DH Backer Panel 48x09
DHBP5409	DH Backer Panel 54x09
DHBP6009	DH Backer Panel 60x09
DHBP6609	DH Backer Panel 66x09

Replacement Items

Glass/Mullion Doors Carriage House Series

	Glass Door Code	Width	Height
15	DRG1515	14 ^{11/16}	13 ^{27/32}
	DRG1815	17 ^{11/16}	13 ^{27/32}
18	DRG0918	8 ^{11/16}	16 ^{27/32}
	DRG1118	10 ^{11/16}	17 ^{27/32}
	DRG1218	11 ^{11/16}	18 ^{27/32}
	DRG1318	12 ^{3/16}	19 ^{27/32}
	DRG1518	14 ^{11/16}	20 ^{27/32}
	DRG1618	16 ^{3/16}	21 ^{27/32}
	DRG1818	17 ^{11/16}	22 ^{27/32}
	DRG1918	19 ^{3/16}	23 ^{27/32}
	DRG2118	20 ^{11/16}	24 ^{27/32}
	24	DRG1524	14 ^{11/16}
DRG1824		16 ^{3/16}	26 ^{27/32}
30	DRG1330	12 ^{3/16}	27 ^{27/32}
	DRG1530	14 ^{11/16}	28 ^{27/32}
	DRG1630	16 ^{3/16}	29 ^{27/32}
	DRG1830	17 ^{11/16}	30 ^{27/32}
36	DRG2130	20 ^{11/16}	31 ^{27/32}
	DRG1336	12 ^{3/16}	32 ^{27/32}
	DRG1536	14 ^{11/16}	33 ^{27/32}
	DRG1636	16 ^{3/16}	34 ^{27/32}
	DRG1836	17 ^{11/16}	35 ^{27/32}
42	DRG2136	20 ^{11/16}	36 ^{27/32}
	DRG1342	12 ^{3/16}	37 ^{27/32}
	DRG1542	14 ^{11/16}	38 ^{27/32}
	DRG1642	16 ^{3/16}	39 ^{27/32}
	DRG1842	17 ^{11/16}	40 ^{27/32}
48	DRG2142	20 ^{11/16}	41 ^{27/32}
	DRG1348	12 ^{3/16}	42 ^{27/32}
	DRG1548	14 ^{11/16}	43 ^{27/32}
	DRG1648	16 ^{3/16}	44 ^{27/32}
	DRG1848	17 ^{11/16}	45 ^{27/32}
	DRG2148	20 ^{11/16}	48 ^{27/32}
	DRG1548-WD	14 ^{11/16}	46 ^{27/32}
54	DRG1848-WD	17 ^{11/16}	47 ^{27/32}
	DRG1554-WD	14 ^{11/16}	49 ^{27/32}
	DRG1854-WD	17 ^{11/16}	50 ^{27/32}

	Mullion Door Code	Width	Height
18	DRM0918	8 ^{11/16}	16 ^{27/32}
	DRM1218	11 ^{11/16}	16 ^{27/32}
	DRM1318	13 ^{3/16}	16 ^{27/32}
	DRM1518	14 ^{11/16}	16 ^{27/32}
	DRM1618	16 ^{3/16}	16 ^{27/32}
	DRM1818	17 ^{11/16}	16 ^{27/32}
	DRM1918	19 ^{3/16}	16 ^{27/32}
	DRM2118	20 ^{11/16}	16 ^{27/32}
24	DRM1524	14 ^{11/16}	22 ^{15/32}
	DRM1824	17 ^{11/16}	22 ^{15/32}
30	DRM1330	12 ^{11/16}	29 ^{13/32}
	DRM1530	14 ^{11/16}	29 ^{13/32}
	DRM1630	16 ^{3/16}	29 ^{13/32}
	DRM1830	17 ^{11/16}	29 ^{13/32}
36	DRM2130	20 ^{11/16}	29 ^{13/32}
	DRM1336	12 ^{11/16}	34 ^{27/32}
	DRM1536	14 ^{11/16}	34 ^{27/32}
	DRM1636	16 ^{3/16}	34 ^{27/32}
	DRM1836	17 ^{11/16}	34 ^{27/32}
42	DRM2136	20 ^{11/16}	34 ^{27/32}
	DRM1342	12 ^{11/16}	40 ^{23/32}
	DRM1542	14 ^{11/16}	40 ^{23/32}
	DRM1642	16 ^{3/16}	40 ^{23/32}
	DRM1842	17 ^{11/16}	40 ^{23/32}
48	DRM2142	20 ^{11/16}	40 ^{23/32}
	DRM1348	12 ^{11/16}	46 ^{13/16}
	DRM1548	14 ^{11/16}	46 ^{13/16}
	DRM1648	16 ^{3/16}	46 ^{13/16}
	DRM1848	17 ^{11/16}	46 ^{13/16}
	DRM2148	20 ^{11/16}	45 ^{23/32}
	DRM1548-WD	14 ^{11/16}	45 ^{23/32}
54	DRM1848-WD	17 ^{11/16}	45 ^{23/32}
	DRM1554-WD	14 ^{11/16}	51 ^{7/16}
	DRM1854-WD	17 ^{11/16}	51 ^{7/16}

Replacement Items

Carriage House Drawer Cores & Pullouts

* Note: Replacement Drawer Kits "RDK", Replacement Pullout Kits "RPK", and "POT" Kits come with inner and outer glide sets

Base Drawer	Width	Depth	Height	
RDK1221	12" Base Drawer	9 ^{3/8}	21	3
RDK1521	15" Base Drawer	12 ^{3/8}	21	3
RDK1821	18" Base Drawer	15 ^{3/8}	21	3
RDK2121	21" Base Drawer	18 ^{3/8}	21	3
RDK2421	24" Base Drawer	21 ^{3/8}	21	3
RDK2721	27" Base Drawer	24 ^{3/8}	21	3
RDK3021	30" Base Drawer	27 ^{3/8}	21	3
RDK3321	33" Base Drawer	30 ^{3/8}	21	3
RDK3621	36" Base Drawer	33 ^{3/8}	21	3

Base Drawer Deep	Width	Depth	Height	
RDK1221D	12" Base Deep Drawer	9 ^{3/8}	21	6 ^{1/4}
RDK1521D	15" Base Deep Drawer	12 ^{3/8}	21	6 ^{1/4}
RDK1821D	18" Base Deep Drawer	15 ^{3/8}	21	6 ^{1/4}
RDK2121D	21" Base Deep Drawer	18 ^{3/8}	21	6 ^{1/4}
RDK2421D	24" Base Deep Drawer	21 ^{3/8}	21	6 ^{1/4}
RDK2721D	27" Base Deep Drawer	24 ^{3/8}	21	6 ^{1/4}
RDK3021D	30" Base Deep Drawer	27 ^{3/8}	21	6 ^{1/4}
RDK3321D	33" Base Deep Drawer	30 ^{3/8}	21	6 ^{1/4}
RDK3621D	36" Base Deep Drawer	33 ^{3/8}	21	6 ^{1/4}

Pullouts	Width	Depth	Height	
RPK1221	12" Pullout	9 ^{11/16}	21	3 ^{1/4}
RPK1521	15" Pullout	12 ^{11/16}	21	3 ^{1/4}
RPK1821	18" Pullout	15 ^{11/16}	21	3 ^{1/4}
RPK2121	21" Pullout	18 ^{11/16}	21	3 ^{1/4}
RPK2421	24" Pullout	21 ^{11/16}	21	3 ^{1/4}
RPK2721	27" Pullout	24 ^{11/16}	21	3 ^{1/4}
RPK3021	30" Pullout	27 ^{11/16}	21	3 ^{1/4}
RPK3321	33" Pullout	30 ^{11/16}	21	3 ^{1/4}
RPK3621	36" Pullout	33 ^{11/16}	21	3 ^{1/4}

Back of pullouts are 3" high and hold up to 75 lbs.

Pullouts - Bottom Mounted	Width	Depth	Height	
RPK1221B	12" Pullout	9 ^{11/16}	21	1 ^{1/2}
RPK1521B	15" Pullout	12 ^{11/16}	21	1 ^{1/2}
RPK1821B	18" Pullout	15 ^{11/16}	21	1 ^{1/2}
RPK2121B	21" Pullout	18 ^{11/16}	21	1 ^{1/2}
RPK2421B	24" Pullout	21 ^{11/16}	21	1 ^{1/2}
RPK2721B	27" Pullout	24 ^{11/16}	21	1 ^{1/2}
RPK3021B	30" Pullout	27 ^{11/16}	21	1 ^{1/2}
RPK3321B	33" Pullout	30 ^{11/16}	21	1 ^{1/2}
RPK3621B	36" Pullout	33 ^{11/16}	21	1 ^{1/2}

Back of pullouts are 1 1/4" high and hold up to 75lbs.

Pullout Tray Kits - Tall Cabinets	Width	Depth	Height	
POT15	15" Pullout Tray Kit	12 ^{11/16}	21	3 ^{1/4}
POT18	18" Pullout Tray Kit	15 ^{11/16}	21	3 ^{1/4}
POT24	24" Pullout Tray Kit	21 ^{11/16}	21	3 ^{1/4}
POT30	30" Pullout Tray Kit	27 ^{11/16}	21	3 ^{1/4}

Hold up to 75lbs.

*Spice Pullouts	Width	Depth	Height	
SPICE-RACK06	For BPO6 cabinet	4 ^{1/2}	23 ^{1/2}	24 ^{1/2}
SPICE-RACK09	For BPO9 cabinet	6 ^{1/2}	23 ^{1/2}	24 ^{1/2}
SPICE-RACK12	For BPO12 cabinet	9 ^{1/2}	23 ^{1/2}	24 ^{1/2}
SPICE-RACK15	For BPO15 cabinet	12 ^{1/2}	23 ^{1/2}	24 ^{1/2}
SPICE-RACK18	For BPO18 cabinet	15 ^{1/2}	23 ^{1/2}	24 ^{1/2}

* Comes with inner glides only, cannot upgrade to soft close glides

Desk File Drawers "DF"	Width	Depth	Height	
RDK1518-AD	15" DF Top Drawer	12 ^{3/8}	18	3 ^{1/8}
RDK1818-AD	18" DF Top Drawer	15 ^{3/8}	18	3 ^{1/8}

* Comes with inner glides only, cannot upgrade to soft close glides

Apron Drawer "AD"	Width	Depth	Height	
RDK1818-AD	18" Apron Drawer	15 ^{3/8}	18	3 ^{1/8}
RDK2418-AD	24" Apron Drawer	21 ^{3/8}	18	3 ^{1/8}
RDK3018-AD	30" Apron Drawer	27 ^{3/8}	18	3 ^{1/8}
RDK3618-AD	36" Apron Drawer	33 ^{3/8}	18	3 ^{1/8}

* Comes with inner glides only, cannot upgrade to soft close glides

Vanity Drawer	Width	Depth	Height	
RDK1218	12" Vanity Drawer	9 ^{3/8}	18	4
RDK1518	15" Vanity Drawer	12 ^{3/8}	18	4
RDK1818	18" Vanity Drawer	15 ^{3/8}	18	4
RDK2118	21" Vanity Drawer	18 ^{3/8}	18	4
RDK2418	24" Vanity Drawer	21 ^{3/8}	18	4
RDK2718	27" Vanity Drawer	24 ^{3/8}	18	4
RDK3018	30" Vanity Drawer	27 ^{3/8}	18	4
RDK3318	33" Vanity Drawer	30 ^{3/8}	18	4
RDK3618	36" Vanity Drawer	33 ^{3/8}	18	4

Vanity Drawer Deep	Width	Depth	Height	
RDK1218D	12" Vanity Deep Drawer	9 ^{3/8}	18	6 ^{1/4}
RDK1518D	15" Vanity Deep Drawer	12 ^{3/8}	18	6 ^{1/4}
RDK1818D	18" Vanity Deep Drawer	15 ^{3/8}	18	6 ^{1/4}
RDK2118D	21" Vanity Deep Drawer	18 ^{3/8}	18	6 ^{1/4}
RDK2418D	24" Vanity Deep Drawer	21 ^{3/8}	18	6 ^{1/4}
RDK2718D	27" Vanity Deep Drawer	24 ^{3/8}	18	6 ^{1/4}
RDK3018D	30" Vanity Deep Drawer	27 ^{3/8}	18	6 ^{1/4}
RDK3318D	33" Vanity Deep Drawer	30 ^{3/8}	18	6 ^{1/4}
RDK3618D	36" Vanity Deep Drawer	33 ^{3/8}	18	6 ^{1/4}

Pullouts - 21" Deep Base Cabinets	Width	Depth	Height	
RPK1218	12" Pullout	9 ^{11/16}	18	3 ^{1/4}
RPK1518	15" Pullout	12 ^{11/16}	18	3 ^{1/4}
RPK1818	18" Pullout	15 ^{11/16}	18	3 ^{1/4}
RPK2118	21" Pullout	18 ^{11/16}	18	3 ^{1/4}
RPK2418	24" Pullout	21 ^{11/16}	18	3 ^{1/4}
RPK2718	27" Pullout	24 ^{11/16}	18	3 ^{1/4}
RPK3018	30" Pullout	27 ^{11/16}	18	3 ^{1/4}
RPK3318	33" Pullout	30 ^{11/16}	18	3 ^{1/4}
RPK3618	36" Pullout	33 ^{11/16}	18	3 ^{1/4}

Hold up to 75 lbs.

Pullouts- Bottom Mounted - 21" Deep Base Cabinets	Width	Depth	Height	
RPK1218B	12" Pullout	9 ^{11/16}	18	1 ^{1/2}
RPK1518B	15" Pullout	12 ^{11/16}	18	1 ^{1/2}
RPK1818B	18" Pullout	15 ^{11/16}	18	1 ^{1/2}
RPK2118B	21" Pullout	18 ^{11/16}	18	1 ^{1/2}
RPK2418B	24" Pullout	21 ^{11/16}	18	1 ^{1/2}

Inner and Outer Glide Sets Included - Spacers not included for add on in field
Cannot upgrade to soft close glides and trash cans sold separately

Pullouts- Trash Kits	Width	Depth	Height	
RPK1522-TC	15" BTC Base Trash PO	12 ^{9/32}	22 ^{3/16}	4
RPK1822-TC	18" BTC Base Trash PO	15 ^{9/32}	22 ^{3/16}	4
RPK2122-TC	21" BTC Base Trash PO	18 ^{9/32}	22 ^{3/16}	4
RPK1522-TCFH	15" BTCFH Base Trash PO	12 ^{9/32}	22 ^{3/16}	4
RPK1822-TCFH	18" BTCFH Base Trash PO	15 ^{9/32}	22 ^{3/16}	4
RPK2122-TCFH	21" BTCFH Base Trash PO	18 ^{9/32}	22 ^{3/16}	4

Pullouts- Trash Units	Width	Depth	Height	
POTC1522	15" BTC Trash PO	12 ^{9/32}	22 ^{3/16}	4
POTC1822	18" BTC Trash PO	15 ^{9/32}	22 ^{3/16}	4
POTC2122	21" BTC Trash PO	18 ^{9/32}	22 ^{3/16}	4

Inner and Outer Glide Sets Included - Spacers not included for add on in field
Cannot upgrade to soft close glides and trash cans sold separately

Trash Cans	Width	Depth	Height	
TRASH-CAN35	35 Qt Trash Can	10 ^{1/2}	17 ^{3/4}	14
TRASH-CAN50	50 Qt Trash Can	10 ^{1/2}	21 ^{3/4}	14

Pullouts w/ Canisters	Width	Depth	Height	
PO-CANS0924	For BPOC9	6 ^{1/2}	23 ^{1/2}	24 ^{1/2}
PO-CANS1224	For BPOC12	9 ^{1/2}	23 ^{1/2}	24 ^{1/2}

Deep Drawers "BDD" "DF" & "DDF"	Width	Depth	Height	
RDK1520	15" Drawer - Bottom	12 ^{3/4}	20	9 ^{13/16}
RDK1820	18" Drawer - Bottom	15 ^{3/4}	20	9 ^{13/16}
RDK2920	29" Drawer - BDD30	27 ^{1/4}	20	9 ^{13/16}
RDK3020	30" Drawer - DDF	27 ^{3/4}	20	9 ^{13/16}
RDK3220	32" Drawer - BDD33	32 ^{3/4}	20	9 ^{13/16}
RDK3520	35" Drawer - BDD36	32 ^{1/4}	20	9 ^{13/16}
RDK3620	36" Drawer - DDF	33 ^{3/4}	20	9 ^{13/16}

Replacement Items

Carriage House Drawer Cores & Pullouts (continued)

Apron Drawer Keyboard "ADK"		Width	Depth	Height
POKT24	24" ADK Vanity Drwr	20 ^{11/16}	20	3/4
POKT30	30" ADK Vanity Drwr	26 ^{11/16}	20	3/4
POKT36	36" ADK Vanity Drwr	32 ^{11/16}	20	3/4

DOUBLE DEEP DRAWER	
RDK2421DD	24" BDD
RDK2721DD	27" BDD

*Wall Drawers "WD"		Width	Depth	Height
RDK1509	15" Wall Drawer	12 ^{3/8}	10 ^{1/8}	4
RDK1809	18" Wall Drawer	15 ^{3/8}	10 ^{1/8}	4
RDK3009	30" Wall Drawer	27 ^{3/8}	10 ^{1/8}	4
RDK3609	36" Wall Drawer	33 ^{3/8}	10 ^{1/8}	4

STANDARD

Carriage House Shelving

* Note: Replacement Shelf Kits come with shelf pins

Wall Shelves - 12" Deep "STD Size"		Width	Depth
SH09	9" Shelf	7 ^{7/16}	10 ^{3/8}
SH12	12" Shelf	10 ^{7/16}	10 ^{3/8}
SH15	15" Shelf	13 ^{7/16}	10 ^{3/8}
SH18	18" Shelf	16 ^{7/16}	10 ^{3/8}
SH21	21" Shelf	19 ^{7/16}	10 ^{3/8}
SH24	24" Shelf	22 ^{7/16}	10 ^{3/8}
SH27	27" Shelf	25 ^{7/16}	10 ^{3/8}
SH30	30" Shelf	28 ^{7/16}	10 ^{3/8}
SH33	33" Shelf	31 ^{7/16}	10 ^{3/8}
SH36	36" Shelf	34 ^{7/16}	10 ^{3/8}
SH39	39" Shelf	37 ^{7/16}	10 ^{3/8}
SH42	42" Shelf	40 ^{7/16}	10 ^{3/8}
SH45	45" Shelf	43 ^{7/16}	10 ^{3/8}
SH48	48" Shelf	46 ^{7/16}	10 ^{3/8}

Wall Shelves - 15" Deep		Width	Depth
SH1515	15" Deep Shelf	13 ^{7/16}	13 ^{3/8}
SH1815	15" Deep Shelf	16 ^{7/16}	13 ^{3/8}
SH3015	15" Deep Shelf	28 ^{7/16}	13 ^{3/8}
SH3615	15" Deep Shelf	34 ^{7/16}	13 ^{3/8}
SH4815	15" Deep Shelf	46 ^{7/16}	13 ^{3/8}

Wall Shelves - 24" Deep		Width	Depth
SH1524	24" Deep Shelf	13 ^{7/16}	23 ^{1/8}
SH1824	24" Deep Shelf	16 ^{7/16}	23 ^{1/8}
SH2424	24" Deep Shelf	22 ^{7/16}	23 ^{1/8}
SH3024	24" Deep Shelf	28 ^{7/16}	23 ^{1/8}
SH3324	24" Deep Shelf	31 ^{7/16}	23 ^{1/8}
SH3624	24" Deep Shelf	34 ^{7/16}	23 ^{1/8}

Wall Corner Shelves		Width	Depth
WCSH24	24" Wall Corner Shelf	22 ^{5/8}	22 ^{5/8}
WCSH27	27" Wall Corner Shelf	25 ^{5/8}	22 ^{5/8}
WPCSH24	24" Wall Pie Cut Corner Shelf	22 ^{7/16}	10 ^{3/8}

Pantry Shelf Kits (12" Deep Utility)		Width	Depth
PSK15	15" Pantry Shelf Kit- 4pk	13 ^{7/16}	10 ^{3/8}
PSK18	18" Pantry Shelf Kit- 4pk	16 ^{7/16}	10 ^{3/8}
PSK24	24" Pantry Shelf Kit- 4pk	22 ^{7/16}	10 ^{3/8}
PSK30	30" Pantry Shelf Kit- 4pk	28 ^{7/16}	10 ^{3/8}

Full Depth Shelf Kits (24" Deep Utility)		Width	Depth
FDSK15	15" Full Depth Shelf Kit- 4pk	13 ^{7/16}	23 ^{1/8}
FDSK18	18" Full Depth Shelf Kit- 4pk	16 ^{7/16}	23 ^{1/8}
FDSK24	24" Full Depth Shelf Kit- 4pk	22 ^{7/16}	23 ^{1/8}
FDSK30	30" Full Depth Shelf Kit- 4pk	28 ^{7/16}	23 ^{1/8}

Shelf Hardware	
SHELF PINS	Standard Wall Shelf Pins (12 per pack)

PLYWOOD

Wall Shelves - 12" Deep "STD Size"		Width	Depth
SH09-PLY	9" Shelf	7 ^{7/16}	10 ^{3/8}
SH12-PLY	12" Shelf	10 ^{7/16}	10 ^{3/8}
SH15-PLY	15" Shelf	13 ^{7/16}	10 ^{3/8}
SH18-PLY	18" Shelf	16 ^{7/16}	10 ^{3/8}
SH21-PLY	21" Shelf	19 ^{7/16}	10 ^{3/8}
SH24-PLY	24" Shelf	22 ^{7/16}	10 ^{3/8}
SH27-PLY	27" Shelf	25 ^{7/16}	10 ^{3/8}
SH30-PLY	30" Shelf	28 ^{7/16}	10 ^{3/8}
SH33-PLY	33" Shelf	31 ^{7/16}	10 ^{3/8}
SH36-PLY	36" Shelf	34 ^{7/16}	10 ^{3/8}
SH39-PLY	39" Shelf	37 ^{7/16}	10 ^{3/8}
SH42-PLY	42" Shelf	40 ^{7/16}	10 ^{3/8}
SH45-PLY	45" Shelf	43 ^{7/16}	10 ^{3/8}
SH48-PLY	48" Shelf	46 ^{7/16}	10 ^{3/8}

Wall Shelves - 15" Deep		Width	Depth
SH1515-PLY	15" Deep Shelf	13 ^{7/16}	13 ^{3/8}
SH1815-PLY	15" Deep Shelf	16 ^{7/16}	13 ^{3/8}
SH3015-PLY	15" Deep Shelf	28 ^{7/16}	13 ^{3/8}
SH3615-PLY	15" Deep Shelf	34 ^{7/16}	13 ^{3/8}
SH4815-PLY	15" Deep Shelf	48 ^{7/16}	13 ^{3/8}

Wall Shelves - 24" Deep		Width	Depth
SH1524-PLY	24" Deep Shelf	13 ^{7/16}	23 ^{1/8}
SH1824-PLY	24" Deep Shelf	16 ^{7/16}	23 ^{1/8}
SH2424-PLY	24" Deep Shelf	22 ^{7/16}	23 ^{1/8}
SH3024-PLY	24" Deep Shelf	28 ^{7/16}	23 ^{1/8}
SH3324-PLY	24" Deep Shelf	31 ^{7/16}	23 ^{1/8}
SH3624-PLY	24" Deep Shelf	34 ^{7/16}	23 ^{1/8}

Wall Corner Shelves		Width	Depth
WCSH24-PLY	24" Wall Corner Shelf	22 ^{5/8}	22 ^{5/8}
WCSH27-PLY	27" Wall Corner Shelf	25 ^{5/8}	22 ^{5/8}
WPCSH24-PLY	24" Wall Pie Cut Corner Shelf	22 ^{7/16}	10 ^{3/8}

Replacement Items

Carriage House Veneer Shelving for Cabinets with Finished Interiors

STANDARD

Veneer Shelf - Standard Glass and Mullion Cabinets		Width	Depth	Thickness
VSH15	15" Veneer Shelf	13 ^{7/16}	10 ^{3/8}	3/4
VSH18	18" Veneer Shelf	16 ^{7/16}	10 ^{3/8}	3/4
VSH21	21" Veneer Shelf	19 ^{7/16}	10 ^{3/8}	3/4
VSH24	24" Veneer Shelf	22 ^{7/16}	10 ^{3/8}	3/4
VSH27	27" Veneer Shelf	25 ^{7/16}	10 ^{3/8}	3/4
VSH30	30" Veneer Shelf	28 ^{7/16}	10 ^{3/8}	3/4
VSH33	33" Veneer Shelf	31 ^{7/16}	10 ^{3/8}	3/4
VSH36	36" Veneer Shelf	34 ^{7/16}	10 ^{3/8}	3/4

Veneer Shelf - 15" Deep - Glass and Mullion Cabinets		Width	Depth	Thickness
VSH1515	15" Veneer Shelf - 15" Deep	13 ^{7/16}	13 ^{3/8}	3/4
VSH1815	18" Veneer Shelf - 15" Deep	16 ^{7/16}	13 ^{3/8}	3/4
VSH3015	30" Veneer Shelf - 15" Deep	28 ^{7/16}	13 ^{3/8}	3/4
VSH3615	36" Veneer Shelf - 15" Deep	34 ^{7/16}	13 ^{3/8}	3/4

Custom Shelf Kit		Width	Depth	Thickness
CSK96	96" Long Wood Veneer Shelf	96	13	3/4

Veneer Shelf Full Width - Finished with Color of Kitchen		Width	Depth	Thickness
VSHFW30	30" Veneer Shelf	30	10 ^{3/8}	3/4
VSHFW33	33" Veneer Shelf	33	10 ^{3/8}	3/4
VSHFW36	36" Veneer Shelf	36	10 ^{3/8}	3/4
VSHFW42	42" Veneer Shelf	42	10 ^{3/8}	3/4

Glass Shelf Kits		Width	Depth	Thickness
GSK15/2	15" with 2 Shelves	13 ^{7/16}	10 ^{3/8}	3/8
GSK15/3	15" with 3 Shelves	13 ^{7/16}	10 ^{3/8}	3/8
GSK18/2	18" with 2 Shelves	16 ^{7/16}	10 ^{3/8}	3/8
GSK18/3	18" with 3 Shelves	16 ^{7/16}	10 ^{3/8}	3/8
GSK30/2	30" with 2 Shelves	28 ^{7/16}	10 ^{3/8}	3/8
GSK30/3	30" with 3 Shelves	28 ^{7/16}	10 ^{3/8}	3/8
GSK33/2	33" with 2 Shelves	31 ^{7/16}	10 ^{3/8}	3/8
GSK33/3	33" with 3 Shelves	31 ^{7/16}	10 ^{3/8}	3/8
GSK36/2	36" with 2 Shelves	34 ^{7/16}	10 ^{3/8}	3/8
GSK36/3	36" with 3 Shelves	34 ^{7/16}	10 ^{3/8}	3/8

Wall Corner Shelves		Width	Depth	Thickness
VSHWC24	24" Veneer WC Shelf	22 ^{5/8}	22 ^{1/2}	3/4
VSHWC27	27" Veneer WC Shelf	25 ^{5/8}	22 ^{1/2}	3/4

Shelf Hardware	
SHELF PINS	Standard Wall Shelf Pins (12 per pack)

Replacement Items

PLYWOOD

Veneer Shelf - 15" Deep - Glass and Mullion Cabinets				
PLYWOOD		Width	Depth	Thickness
VSH15-PLY	15" Veneer Shelf	13 ^{7/16}	10 ^{3/8}	3/4
VSH18-PLY	18" Veneer Shelf	16 ^{7/16}	10 ^{3/8}	3/4
VSH21-PLY	21" Veneer Shelf	19 ^{7/16}	10 ^{3/8}	3/4
VSH24-PLY	24" Veneer Shelf	22 ^{7/16}	10 ^{3/8}	3/4
VSH27-PLY	27" Veneer Shelf	25 ^{7/16}	10 ^{3/8}	3/4
VSH30-PLY	30" Veneer Shelf	28 ^{7/16}	10 ^{3/8}	3/4
VSH33-PLY	33" Veneer Shelf	31 ^{7/16}	10 ^{3/8}	3/4
VSH36-PLY	36" Veneer Shelf	34 ^{7/16}	10 ^{3/8}	3/4

Veneer Shelf - 15" Deep - Glass and Mullion Cabinets				
PLYWOOD		Width	Depth	Thickness
VSH1515-PLY	15" Veneer Shelf	13 ^{7/16}	13 ^{3/8}	3/4
VSH1815-PLY	18" Veneer Shelf	16 ^{7/16}	13 ^{3/8}	3/4
VSH3015-PLY	30" Veneer Shelf	28 ^{7/16}	13 ^{3/8}	3/4
VSH3615-PLY	36" Veneer Shelf	34 ^{7/16}	13 ^{3/8}	3/4

Veneer Shelf Full Width - Finished with Color of Kitchen				
PLYWOOD		Width	Depth	Thickness
VSHFW30-PLY	30" Veneer Shelf	30	12	3/4
VSHFW33-PLY	33" Veneer Shelf	33	12	3/4
VSHFW36-PLY	36" Veneer Shelf	36	12	3/4
VSHFW42-PLY	42" Veneer Shelf	42	12	3/4

Wall Corner Shelves				
PLYWOOD		Width	Depth	Thickness
VSHWC24-PLY	24" Veneer Shelf	22 ^{5/8}	22 ^{1/2}	3/4
VSHWC27-PLY	27" Veneer Shelf	25 ^{5/8}	22 ^{1/2}	3/4

Long TAB along the right side
EURO Specifications

EURO Specifications

- ***Construction Features, Upgrade Options & Available Modifications***
- ***Terms & Policies***
- ***Warranty Information***
- ***Product Care & Cleaning***
- ***Industry Qualifications***
- ***Custom Item Form***

EURO Specifications: Construction Features, Upgrade Options & Modifications

Euro Series Standard Construction Features

- Horizontal Construction Braces
- Unfinished Sides, Tops & Bottoms - 5/8" Thick Furniture Board
- Gray Laminate Interior Finish (Capri - Interior of End Panel Matches Door)
- 5/8" Gray Laminated Pinned Furniture Board Drawer Box with Undermount Full Access Glides, Soft-Close
- 3/4" Thick Gray Furniture Board Shelves with PVC Edge Banding
- Half Depth Fixed Base Shelf
- Adjustable Door Hinges, Non-Soft Close
- 10-Year Factory Warranty

Upgraded Construction Options (A La Carte Upgrades)

Code	Description
SCH	Soft-Close Adjustable Door Hinges
ETD	Euro Tech Drawer Box with Full Extension Soft-Close Glides
UPO	Mid Mounted Gray Laminated Pinned Pull-Out Tray, Soft-Close
2PO	Bottom Mounted Gray Laminated Pinned Pull-Out Tray, Soft-Close
VL/VR/VV	Finished Sides - 5/8" Thick Furniture Board with Matching Laminate Exterior
BOX	Box with No Doors or Drawer Heads

Finished Side Charges

Description	Veneer Code
12" High - Wall	WV12
15" High - Wall	WV15
18" High - Wall	WV18
24" High - Wall	WV24
30" High - Wall	WV30
36" High - Wall	WV36
42" High - Wall	WV42
48" High - Wall	WV48
54" High - Wall	WV54
60" High - Wall	WV60
Base OR Vanity	BV34
84" High - Taller	BV84
90" High - Taller	BV90
96" High - Taller	BV96

Available Modifications

Code	Description
NGL	No Glass Door
FTA	Feet Add-On
NFT	No Adjustable Feet
364	Box Only (No Doors/Drawer Heads/Drawer Box/Hinges)
BNS*	Box Only-No Fixed Shelf (No Doors/ Drawer Heads/ Drawer Box/Hinges/Fixed Shelf)
	* Note: To Be Used on Base Cabinetry Only

EURO Specifications: Terms & Policies

LEAD TIMES/CHANGE ORDERS/CANCELLATIONS

STANDARD ORDERS (4 week lead times plus delivery) - Century provides a two (2) day time period from date of order acknowledgement to change/cancel order. After that time and release of order, it will be locked into production. Subsequent changes or cancellation of the order will result in:

- **WEEK 1 – 25% CHARGE FOR WORK IN PROGRESS**
- **WEEK 2 – 50% CHARGE FOR WORK IN PROGRESS**
- **WEEK 3 & 4 – 100% CHARGE FOR WORK IN PROGRESS**

SHORT-LEAD WAIVER (3 week lead times plus delivery) - Century provides zero (0) day time period from date of order acknowledgement to change/cancel an order. The order is immediately processed, released, and locked into production. Changes or cancellation of the order will result in:

- **WEEK 1 – 25% CHARGE FOR WORK IN PROGRESS**
- **WEEK 2 – 50% CHARGE FOR WORK IN PROGRESS**
- **WEEK 3 – 100% CHARGE FOR WORK IN PROGRESS**

Note: Capri door adds one week lead time to standard orders and short-lead waiver.

TERMS AND CONDITIONS OF SALE

- 1) 50% DEPOSIT is required to process all orders over \$5,000 for C.I.A. (Cash In Advance) customers. Orders less than \$10,000 are required to be paid in full. Accounts with established credit terms may remit payment with bank checks, company checks, and wire transfers of funds. Century accepts most major credit card payments for retail sales only. Century will not hold or accept post dated checks. A \$50 service charge will be applied for check returned from bank for non-sufficient funds. Balance is due five (5) business days prior to delivery. If not paid, delivery will be cancelled and not re-scheduled until balance is paid in full.
- 2) Installation and adjustment of merchandise is the responsibility of the customer.
- 3) Delivery date on order acknowledgement is tentative. Customer will be advised of delivery date approximately one (1) week prior to date on order. Material held after thirty (30) days from delivery date will be disposed of and deposit forfeited or a storage fee of \$100 per week will be added to the balance.
- 4) Delivery must be cancelled by 9am the day before delivery or a charge of \$100 will be applied to deliver cabinets on the next scheduled day.
- 5) Customer or authorized representative must be present at delivery site to sign for merchandise. Deliveries unable to be made will incur an additional \$350 charge and applied to re-scheduled delivery.
- 6) It is the buyers responsibility, at time of delivery, to verify quantities received, inspect cartons for visible damage, sign and date shipping tickets.
- 7) Claims for shortages, errors, and damages must be noted on shipping ticket at time of delivery. Concealed damages must be reported to your Century Sales Representative/Administrator within 1 week of shipment.
- 8) Cabinetry is NOT RETURNABLE unless defective. Defective items need to be returned within 30 days of delivery uninstalled and in original box. Stocked accessories may be returned with a 35% re-stocking fee. Returned accessories must be in good condition or no credit will be issued.
- 9) Century Cabinetry has a 10-year limited warranty, effective as of 4/1/12. Century Cabinetry will repair or replace any material that proves defective. Claims for labor installation cost will NOT be accepted.

10 Year Limited Warranty

Century Cabinetry, Inc. warrants its products to be free from defects in material or workmanship under normal use for a period of 10 years from date of purchase by the original consumer purchaser and is not transferrable to subsequent homeowners. Should defects in material or workmanship arise during this warranty period, Century Cabinetry, Inc. will replace or repair, at its discretion, the defective cabinet, material or component.

This warranty does not cover products that are misused, abused, neglected, modified, improperly stored, incorrectly installed, or subjected to extremes in moisture or temperature.

This warranty covers only parts and materials of the products manufactured by Century Cabinetry, Inc.. Not covered under this warranty are countertops, appliances, plumbing fixtures, etc or the costs (including labor) to remove or re-install materials or related items such as plumbing fixtures, countertops, appliances...

Changes to Finishes or Product Design

Century Cabinetry may modify product due to supplier availability and as changes or improvements are implemented, but is under no obligation to make these changes to previously manufactured product.

If a warranty claim is filed after a product or finish becomes obsolete, Century Cabinetry reserves the right to honor the warranty in the following ways:

- a. To replace the affected component with a new component of the same style
- b. To replace the affected component with any other component(s) to achieve a similar appearance with a style that is comparable in appearance, color, design or construction based upon current product offerings.

If components are replaced, Century Cabinetry cannot guarantee that the finish of these items will be an exact match to the finish and appearance of the original purchased components.

Implied Warranties

This warranty is only valid in the United States of America. To the extent permitted by law, any implied warranties, including the implied warranties of merchantability and fitness for a particular purpose, are limited to the duration of this express warranty. This warranty excludes any incidental or consequential damages. Some states do not allow limitations on how long an implied warranty lasts, so the above limitations may not apply to you.

Making a Claim

To make a claim under this warranty, the purchaser must contact their local Century dealer or distributor and report said defects. If you have difficulty obtaining assistance write to: Century Cabinetry Inc. 220 Phillips Road Exton, PA 19341. Attn: Customer Warranty/Service Department. To ensure timely processing, please include your name, phone number, builder or contractor name, lot number, address, city, state, and zip code.

Warranty Effective Date

This warranty is effective as of April 1, 2012 and covers all cabinets ordered on or after this date. Cabinets ordered before April 1, 2012 are covered under the preceding **FIVE-YEAR** warranty.

THIS WARRANTY IS THE EXCLUSIVE WARRANTY OF CENTURY CABINETRY AND IS IN LIEU OF ALL OTHER WARRANTIES, EITHER EXPRESSED OR IMPLIED. IN NO EVENT SHALL CENTURY CABINETRY BE LIABLE FOR CONSEQUENTIAL, INDIRECT OR INCIDENTAL DAMAGES RESULTING FROM THE INSTALLATION, USE OR FAILURE OF ITS PRODUCT.

Care & Cleaning Guidelines

The following guidelines and suggestions should help keep your cabinetry looking beautiful for many years.

General Cleaning and Care of Euro Cabinets

Remove any oil, grease, or soil, using a clean damp cloth of mild soap and water. Rinse with a clean damp cloth. Dry thoroughly with a soft lint-free cloth. DO NOT use steel wool, soap pads, polishing wax or cleaners containing bleach, ammonia, harsh detergents, and abrasives.

Routine cleaning can help prevent permanent damage from build up of grease and smoke.

Excess moisture can also damage cabinets. The most common areas for moisture build-up are around the sink, range, dishwasher, oven, and baseboard. Immediately dry surfaces with a clean cloth.

Care of Cabinet Interiors

Century Cabinetry's shelves are made of low pressure laminate which is a material that is resistant to scratches, stains, and water penetration

To remove food residue or grease, use any common dishwashing liquid (not detergent) or a solution of mild soap and water. Wipe clean with a clean soft damp cloth and dry thoroughly. Wipe up spills and dry immediately.

Self-Cleaning Ovens

Self-cleaning ovens are cleaned through the use of intense heat. If the heat gasket does not seal properly, heat may escape from the oven. Cabinet components installed near the oven may suffer finish or surface damage.

To minimize risk of damage during cleaning cycles, we recommend that you remove doors and drawers from cabinets that are above and adjacent to a self-cleaning oven.

Century Cabinetry is committed to conducting our business in an environmentally responsible manner. Our commitment to environmental awareness and preservation is reflected throughout our business. Century's cabinetry is manufactured using environmentally friendly practices.

KCMA Certified



Century Cabinetry has been certified by the Kitchen Cabinet Manufacturers Association (KCMA) as meeting the standards for their Environmental Stewardship Program (ESP). Our organization is committed to meeting and further exceeding the standards as set forth by the leaders in our industry. Visit WWW.KCMA.ORG for more information.

CARB II Compliant

California Air Resources Board (CARB) continues in the development of innovative air pollution control strategies. CARB II is the toughest standard in the world for formaldehyde emission levels from composite wood panels. Century Cabinetry products are CARB II compliant. Visit WWW.ARB.CA.GOV for more information.

LEADERSHIP IN ENERGY ENVIRONMENTAL DESIGN (LEED)

LEED is a nationally accepted benchmark for the design, construction and operation of high-performance green buildings. The LEED certification program is run under the guidance of the US Green Building Council (USGBC). Please visit WWW.USGBC.ORG for more information. Century Cabinetry can provide cabinets to fulfill most of your LEED project requirements.

EURO Specifications: Custom Item Form

Reset Form

Please Fax To:
610-363-5409
Attn: Production Manager



rev: 05-23-13

Custom Item Worksheet

Please submit this form for approval and quote from Century Cabinetry

Century Cabinetry recommends that you obtain approval prior to committing to your customer that this custom option is available. Please allow 3 days for a response.

Please include the following details:

Customer Name: _____ Date: _____

Project Name: _____ Lot# /Tag: _____

Product Series:

Door Style: _____ Finish: _____ GHS CHS EURO

Description of Request:

Please provide a drawing:

Width _____ Height _____ Depth _____

APPROVED:

YES Approved By: _____ Date: _____

NO Total List Price: _____ Extra Lead Time Required: _____ Weeks

Approval Code: _____



Email to Century Production Manager

TAB: EURO Doors & Finishes

- *Door Style Quick References*
- *Door Styles & Finish Information*

EURO Doors & Finishes: Door Style Quick Reference

Style Name	Style Code	Price Column	Species	Door	Drawer Head
<i>Vista</i>					
Driftwood	VD	E	Textured Laminate	5-Piece	Matching
<i>Sienna</i>					
Driftwood	ID	C	Textured Laminate	1-Piece	1-Piece
North Latitude	IN	C	Textured Laminate	1-Piece	1-Piece
River Rock	IV	C	Textured Laminate	1-Piece	1-Piece
West Latitude	IW	C	Textured Laminate	1-Piece	1-Piece
Sahara	IS	C	Textured Laminate	1-Piece	1-Piece
<i>Capri</i>					
Hi-Gloss White	CW	J	Acrylic	1-Piece	1-Piece

VISTA	TEXTURED LAMINATE	AVAILABLE FINISHES					
 <p>3/4" Thick Textured Laminate Slim Shaker Panel</p> <p>Full Overlay</p> <p>6 Way Adjustable Concealed Hinge</p> <p>Matching Drawer Head</p> <p>*Decorative hardware is required</p>		<table border="1"> <tr> <td>• Driftwood</td> </tr> </table>	• Driftwood				
• Driftwood							
SIENNA	TEXTURED LAMINATE	AVAILABLE FINISHES					
 <p>3/4" Thick Textured Laminate Slab Panel</p> <p>Full Overlay</p> <p>6 Way Adjustable Concealed Hinge</p> <p>One Piece Drawer Head</p> <p>Vertical Grain Direction</p> <p>*Decorative hardware is required</p>		<table border="1"> <tr> <td>• Driftwood</td> </tr> <tr> <td>• North Latitude</td> </tr> <tr> <td>• River Rock</td> </tr> <tr> <td>• Sahara</td> </tr> <tr> <td>• West Latitude</td> </tr> </table>	• Driftwood	• North Latitude	• River Rock	• Sahara	• West Latitude
• Driftwood							
• North Latitude							
• River Rock							
• Sahara							
• West Latitude							
CAPRI	ACRYLIC	AVAILABLE FINISHES					
 <p>3/4" Thick Hi-Gloss Slab Panel</p> <p>Full Overlay</p> <p>6 Way Adjustable Concealed Hinge</p> <p>One Piece Drawer Head</p> <p>*Decorative hardware is required</p>		<table border="1"> <tr> <td>• Hi-Gloss White</td> </tr> </table>	• Hi-Gloss White				
• Hi-Gloss White							

FROSTED GLASS

Available EURO Door Styles



Available on all EURO Door Styles

Vista glass door manufactured as a sienna glass door.

TAB: EURO Wall Cabinetry

- ***Index***
- ***Construction Options & Modifications Key***
- ***Cabinet Selection***

EURO Wall Cabinetry

Page Location	Cabinet Type	Nomenclature
157	Construction Options & Modifications Key	
158-159	Wall	W
160	Wall Blind Corner	WBC
160	Wall Corner	WC
160	Wall Pie Cut	WPC
160	Wall Drawer	WD
159	Wall Flip Up	WFLIP
160	Wall Lift Up	WLIFT
161	Wall Range Hood	WRH





Wall Cabinets

Finished Side Charges	
Description	Veneer Code
12" High - Wall	WV12
15" High - Wall	WV15
18" High - Wall	WV18
24" High - Wall	WV24
30" High - Wall	WV30
36" High - Wall	WV36
42" High - Wall	WV42
48" High - Wall	WV48
54" High - Wall	WV54
60" High - Wall	WV60

Cabinet Modification Codes	
FTA	Feet Add-On
NFT	No Adjustable Feet
364	Box Only (No Doors/Drawer Heads/Drawer Box/Hinges)
SCH	Soft-Close Adjustable Door Hinges
ETD	Euro Tech Drawer Box with Full Extension Soft-Close Glides
BOX	Box with No Doors or Drawer Heads

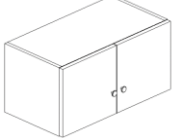
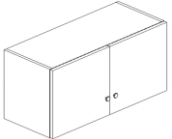
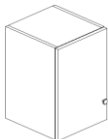
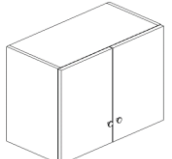

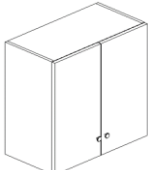
EURO Wall Cabinetry: Cabinet Selection

Wall Cabinets

		Width	Height	Depth	Cabinet Doors	
Wall - Height: 12"						
	W2112 L/R	21	12	12	◆ (1) DR2112	No Shelf
	W2412	24	12	12	◆ (2) DR1212	No Shelf
	W3012	30	12	12	◆ (2) DR1512	
	W3312	33	12	12	◆ (2) DR1612	
	W3612	36	12	12	◆ (2) DR1812	
Wall - Height: 15"						
	W3015	30	15	12	◆ (2) DR1515	No Shelf
	W3315	33	15	12	◆ (2) DR1615	
	W3615	36	15	12	◆ (2) DR1815	
Wall - Height: 18"						
	W1218 L/R	12	18	12	◆ (1) DR1218	No Shelf
	W1518 L/R	15	18	12	◆ (1) DR1518	L/R designates hinging door
	W1818 L/R	18	18	12	◆ (1) DR1818	
	W2118 L/R	21	18	12	◆ (1) DR2118	
	W2418	24	18	12	◆ (2) DR1218	No Shelf
	W2718	27	18	12	◆ (2) DR1318	
	W3018	30	18	12	◆ (2) DR1518	
	W3318	33	18	12	◆ (2) DR1618	
	W3618	36	18	12	◆ (2) DR1818	
Wall - Height: 24"						
	W1224 L/R	12	24	12	◆ (1) DR1224	1 Adjustable Shelf
	W1524 L/R	15	24	12	◆ (1) DR1524	L/R designates hinging door
	W1824 L/R	18	24	12	◆ (1) DR1824	
	W2124 L/R	21	24	12	◆ (1) DR2124	
	W2424	24	24	12	◆ (2) DR1224	1 Adjustable Shelf
	W2724	27	24	12	◆ (2) DR1324	
	W3024	30	24	12	◆ (2) DR1524	
	W3324	33	24	12	◆ (2) DR1624	
	W3624	36	24	12	◆ (2) DR1824	
Wall - Height: 30"						
	W0930 L/R	9	30	12	◆ (1) DR0930	2 Adjustable Shelves
	W1230 L/R	12	30	12	◆ (1) DR1230	L/R designates hinging door
	W1530 L/R	15	30	12	◆ (1) DR1530	
	W1830 L/R	18	30	12	◆ (1) DR1830	
	W2130 L/R	21	30	12	◆ (1) DR2130	
	W2430	24	30	12	◆ (2) DR1230	2 Adjustable Shelves
	W2730	27	30	12	◆ (2) DR1330	
	W3030	30	30	12	◆ (2) DR1530	
	W3330	33	30	12	◆ (2) DR1630	
	W3630	36	30	12	◆ (2) DR1830	

EURO Wall Cabinetry: Cabinet Selection

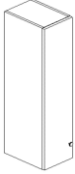
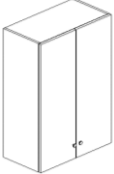
Wall Cabinets

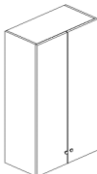
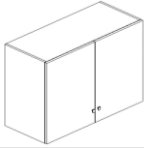
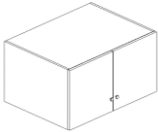
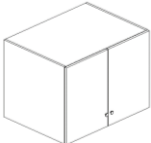
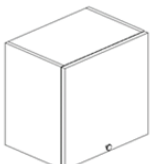
		Width	Height	Depth	Cabinet Doors	
Wall - Height: 36"						
	W0936 L/R	9	36	12	◆ (1) DR0936	2 Adjustable Shelves
	W1236 L/R	12	36	12	◆ (1) DR1236	L/R designates hinging door
	W1536 L/R	15	36	12	◆ (1) DR1536	
	W1836 L/R	18	36	12	◆ (1) DR1836	
	W2136 L/R	21	36	12	◆ (1) DR2136	
	W2436	24	36	12	◆ (2) DR1236	2 Adjustable Shelves
	W2736	27	36	12	◆ (2) DR1336	
	W3036	30	36	12	◆ (2) DR1536	
	W3336	33	36	12	◆ (2) DR1636	
	W3636	36	36	12	◆ (2) DR1836	
Wall - Height: 42"						
	W0942 L/R	9	42	12	◆ (1) DR0942	3 Adjustable Shelves
	W1242 L/R	12	42	12	◆ (1) DR1242	L/R designates hinging door
	W1542 L/R	15	42	12	◆ (1) DR1542	
	W1842 L/R	18	42	12	◆ (1) DR1842	
	W2142 L/R	21	42	12	◆ (1) DR2142	
	W2442	24	42	12	◆ (2) DR1242	3 Adjustable Shelves
	W2742	27	42	12	◆ (2) DR1342	
	W3042	30	42	12	◆ (2) DR1542	
	W3342	33	42	12	◆ (2) DR1642	
	W3642	36	42	12	◆ (2) DR1842	
Wall - Depth: 15" (Double Door)						
	W362415	36	24	15	◆ (2) DR1824	(1) Adjustable 15" Deep Shelf
	W303615	30	36	15	◆ (2) DR1536	
	W363615	36	36	15	◆ (2) DR1836	(2) Adjustable 15" Deep Shelves
	W304215	30	42	15	◆ (2) DR1542	
	W364215	36	42	15	◆ (2) DR1842	
Wall - Depth: 24"						
	W331224	33	12	24	◆ (2) DR1612	No Shelf
	W361224	36	12	24	◆ (2) DR1812	
	W331824	33	18	24	◆ (2) DR1618	
	W361824	36	18	24	◆ (2) DR1818	
	W332424	33	24	24	◆ (2) DR1624	1 Adjustable Shelf
	W362424	36	24	24	◆ (2) DR1824	
	W363024	36	30	24	◆ (2) DR1830	2 Adjustable Shelves
Wall Flip Up						
	WFLIP1818	18	18	12	◆ (1) DR1818	Door opens out and toward you
	WFLIP2418	24	18	12	◆ (1) DR2418	Soft-Close Hinges Standard
	WFLIP3018	30	18	12	◆ (1) DR3018	Cabinet has a bottom floor
	WFLIP3618	36	18	12	◆ (1) DR3618	

EURO Wall Cabinetry: Cabinet Selection

Wall Cabinets

Width Height Depth Cabinet Doors

Wall Lift Up

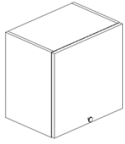

WLIFT1818	18	18	12	◆ (1) DR1818	Door opens out and upward
WLIFT2418	24	18	12	◆ (1) DR2418	Soft-Close Hinges Standard
WLIFT3018	30	18	12	◆ (1) DR3018	Cabinet has a bottom floor
WLIFT3618	36	18	12	◆ (1) DR3618	

Wall Blind Corner

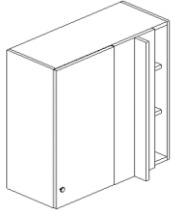

WBC30/3330 L/R	30	30	12	◆ (1) DR1530	2 Adjustable Shelves
WBC36/3930 L/R	36	30	12	◆ (1) DR2130	Closure Panel Attached
WBC30/3336 L/R	30	36	12	◆ (1) DR1536	3" Overlay Corner Filler INCLUDED
WBC36/3936 L/R	36	36	12	◆ (1) DR2136	6" Overlay Filler ATTACHED
WBC30/3342 L/R	30	42	12	◆ (1) DR1542	3 Adjustable Shelves
WBC36/3942 L/R	36	42	12	◆ (1) DR2142	Closure Panel Attached

Cabinet	Cabinet Width	Door Width	Minimum Pull	Maximum Pull
WBC30/3330 L/R	30"	15"	30"	33"
WBC36/3930 L/R	36"	21"	36"	39"
WBC30/3336 L/R	30"	15"	30"	33"
WBC36/3936 L/R	36"	21"	36"	39"
WBC30/3342 L/R	30"	15"	30"	33"
WBC36/3942 L/R	36"	21"	36"	39"

3" Overlay Corner Filler INCLUDED
6" Overlay Filler ATTACHED

Wall Corner 24" (Single Door)

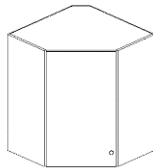

WC2418 L/R	24	18	12	◆ (1) DR15.518	No Adjustable Shelf
WC2430 L/R	24	30	12	◆ (1) DR15.530	2 Adjustable Shelves
WC2436 L/R	24	36	12	◆ (1) DR15.536	
WC2442 L/R	24	42	12	◆ (1) DR15.542	3 Adjustable Shelves

Wall Pie Cut

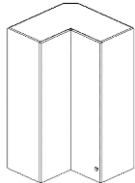

WPC2418 L/R	24	18	12	◆ (2) DR1118	No Adjustable Shelf, N/A with SCH Mod
WPC2430 L/R	24	30	12	◆ (2) DR1130	2 Adjustable Shelves
WPC2436 L/R	24	36	12	◆ (2) DR1136	Not Available with SCH Mod
WPC2442 L/R	24	42	12	◆ (2) DR1142	3 Adjustable Shelves; N/A with SCH Mod

Wall Drawer (Single Door)



WD1548 L/R	15	48	12	◆ (1) DR1542 (1) DH1506	3 Adjustable Shelves
WD1848 L/R	18	48	12	◆ (1) DR1842 (1) DH1806	
WD1554 L/R	15	54	12	◆ (1) DR1548 (1) DH1506	3 Adjustable Shelves
WD1854 L/R	18	54	12	◆ (1) DR1848 (1) DH1806	
WD1560 L/R	15	60	12	◆ (1) DR1554 (1) DH1506	4 Adjustable Shelves
WD1860 L/R	15	60	12	◆ (1) DR1854 (1) DH1806	

EURO Wall Cabinetry: Cabinet Selection

Wall Cabinets

Width Height Depth Cabinet Doors

Wall Range Hood

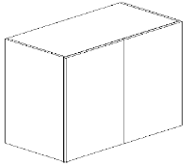

WRH362424	36	24	24	◆ (2) DR1824	6" void at back of box to allow for hood liner clearance
WRH363024	36	30	24	◆ (2) DR1830	Hinged, removable doors
WRH363624	36	36	24	◆ (2) DR1836	Comes with an alumasteel liner as floor
WRH364224	36	42	24	◆ (2) DR1842	
WRH422424	42	24	24	◆ (2) DR2121	6" void at back of box to allow for hood liner clearance
WRH423024	42	30	24	◆ (2) DR2130	Hinged, removable doors
WRH423624	42	36	24	◆ (2) DR2136	Comes with an alumasteel liner as floor
WRH424224	42	42	24	◆ (2) DR2142	

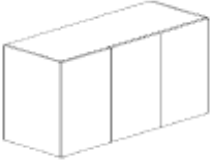

WRH482424	48	24	24	◆ (2) DR1524 (1) DR1824	6" void at back of box to allow for hood liner clearance
WRH483024	48	30	24	◆ (2) DR1530 (1) DR1830	Hinged, removable doors
WRH483624	48	36	24	◆ (2) DR1536 (1) DR1836	Comes with an alumasteel liner as floor
WRH484224	48	42	24	◆ (2) DR1542 (1) DR1842	
WRH544224	54	42	24	◆ (3) DR1842	6" void at back of box to allow for hood liner clearance
					Hinged, removable doors
					Comes with an alumasteel liner as floor

- *Index*
- *Construction Options & Modifications Key*
- *Cabinet Selection*

EURO Specialty Wall Cabinetry

Page Location	Cabinet Type	Nomenclature
164	Construction Options & Modifications Key	
165-166	Wall Glass	WG
166	Wall Glass Flip	WGFLIP
166	Wall Glass Lift Up	WGLIFT
166	Wall Glass Corner	WGC
166	Wall Glass Drawer	WGD
166	Wall Glass Pie Cut	WGPC

Glass Cabinets

Finished Side Charges	
Description	Veneer Code
12" High - Wall	WV12
15" High - Wall	WV15
18" High - Wall	WV18
24" High - Wall	WV24
30" High - Wall	WV30
36" High - Wall	WV36
42" High - Wall	WV42
48" High - Wall	WV48
54" High - Wall	WV54
60" High - Wall	WV60

Cabinet Modification Codes	
FTA	Feet Add-On
NFT	No Adjustable Feet
364	Box Only (No Doors/Drawer Heads/Drawer Box/Hinges)
NGL	No Glass in Door
SCH	Soft-Close Adjustable Door Hinges
ETD	Euro Tech Drawer Box with Full Extension Soft-Close Glides
BOX	Box with No Doors or Drawer Heads

EURO Specialty Wall Cabinetry: Cabinet Selection

All Glass Cabinets:
 Gray Interior - STANDARD
 Matching Interior Not Available

Glass Cabinets

Width Height Depth Cabinet Doors

Wall Glass - Height: 15"

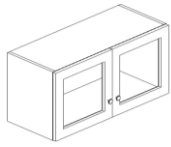

WG3015	30	15	12	◆ (2) DRG1515	No Shelf
WG3615	36	15	12	◆ (2) DRG1815	Frosted Glass

Wall Glass - Height: 18"

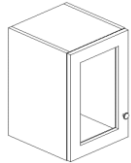

WG1218 L/R	12	18	12	◆ (1) DRG1218	No Shelf
WG1518 L/R	15	18	12	◆ (1) DRG1518	Frosted Glass
WG1818 L/R	18	18	12	◆ (1) DRG1818	L/R designates hinging
WG2118 L/R	21	18	12	◆ (1) DRG2118	

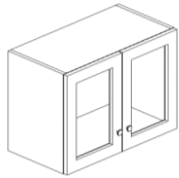

WG2418	24	18	12	◆ (2) DRG1218	No Shelf
WG2718	27	18	12	◆ (2) DRG1318	Frosted Glass
WG3018	30	18	12	◆ (2) DRG1518	
WG3318	33	18	12	◆ (2) DRG1618	
WG3618	36	18	12	◆ (2) DRG1818	

Wall Glass - Height: 24"



WG1824 L/R	18	24	12	◆ (1) DRG1824	1 Adjustable Shelf Frosted Glass L/R designates hinging
-------------------	----	----	----	---------------	---



WG3024	30	24	12	◆ (2) DRG1524	1 Adjustable Shelf
WG3624	36	24	12	◆ (2) DRG1824	Frosted Glass

Wall Glass - Height: 30"



WG1530 L/R	15	30	12	◆ (1) DRG1530	2 Adjustable Shelves
WG1830 L/R	18	30	12	◆ (1) DRG1830	Frosted Glass L/R designates hinging



WG3030	30	30	12	◆ (2) DRG1530	2 Adjustable Shelves
WG3330	33	30	12	◆ (2) DRG1630	Frosted Glass
WG3630	36	30	12	◆ (2) DRG1830	

Wall Glass - Height: 36"



WG1536 L/R	15	36	12	◆ (1) DRG1536	2 Adjustable Shelves
WG1836 L/R	18	36	12	◆ (1) DRG1836	Frosted Glass L/R designates hinging



WG3036	30	36	12	◆ (2) DRG1536	2 Adjustable Shelves
WG3336	33	36	12	◆ (2) DRG1636	Frosted Glass
WG3636	36	36	12	◆ (2) DRG1836	

EURO Specialty Wall Cabinetry: Cabinet Selection

All Glass Cabinets:
 Gray Interior - STANDARD
 Matching Interior Not Available

Glass Cabinets

Width Height Depth Cabinet Doors

Wall Glass - Height: 42"

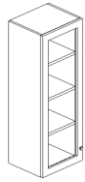

WG1542 L/R	15	42	12	◆ (1) DRG1542	3 Adjustable Shelves
WG1842 L/R	18	42	12	◆ (1) DRG1842	Frosted Glass

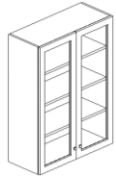

WG3042	30	42	12	◆ (2) DRG1542	3 Adjustable Shelves
WG3342	33	42	12	◆ (2) DRG1642	Frosted Glass
WG3642	36	42	12	◆ (2) DRG1842	

Wall Glass Flip Up

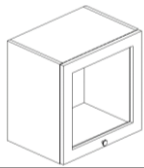

WGFLIP1818	18	18	12	◆ (1) DRG1818	Soft-Close Hinges Standard
WGFLIP2418	24	18	12	◆ (1) DRG2418	Frosted Glass
WGFLIP3018	30	18	12	◆ (1) DRG3018	
WGFLIP3618	36	18	12	◆ (1) DRG3618	

Wall Glass Lift Up

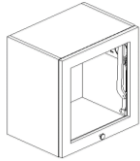

WGLIFT1818	18	18	12	◆ (1) DRG1818	Soft-Close Hinges Standard
WGLIFT2418	24	18	12	◆ (1) DRG2418	Frosted Glass
WGLIFT3018	30	18	12	◆ (1) DRG3018	
WGLIFT3618	36	18	12	◆ (1) DRG3618	

Wall Glass Corner

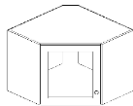

WGC2418 L/R	24	18	12	◆ (1) DRG15.518	No Shelf Frosted Glass
--------------------	----	----	----	-----------------	---------------------------

WGC2430 L/R	24	30	12	◆ (1) DRG15.530	1 Adjustable Shelf
WGC2436 L/R	24	36	12	◆ (1) DRG15.536	Frosted Glass



WGC2442 L/R	24	42	12	◆ (1) DRG15.542	2 Adjustable Shelves Frosted Glass
--------------------	----	----	----	-----------------	---------------------------------------

Wall Glass Pie Cut

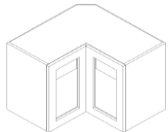

WGPC2418 L/R	24	18	12	◆ (2) DRG1118	No Adjustable Shelf
---------------------	----	----	----	---------------	---------------------

Wall Glass Drawer

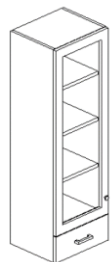

WGD1548 L/R	15	48	12	◆ (1) DRG1542 (1) DH1506	3 Adjustable Shelves
WGD1848 L/R	18	48	12	◆ (1) DRG1842 (1) DH1806	Frosted Glass
WGD1554 L/R	15	54	12	◆ (1) DRG1548 (1) DH1506	3 Adjustable Shelves
WGD1854 L/R	18	54	12	◆ (1) DRG1848 (1) DH1806	Frosted Glass
WGD1560 L/R	15	60	12	◆ (1) DRG1554 (1) DH1506	3 Adjustable Shelves
WGD1860 L/R	18	60	12	◆ (1) DRG1854 (1) DH1806	Frosted Glass

TAB: EURO Base Cabinetry

- *Index*
- *Construction Options & Modifications Key*
- *Cabinet Selection*

EURO Base Cabinetry

Page Location	Cabinet Type	Nomenclature
169	Construction Options & Modifications Key	
170	Base	B
171	Base Blind Corner	BBC
172	Base Blind Corner Swing Out	BBCSO
172	Base Corner Shelf	BCS
173	Base Cooktop	BCT
173	Base Drawer Cooktop	BDCT
170	Base Drawer	BD
173	Base Drawer - ADA	BD-ADA
170	Base 4 Drawer	B4D
170	Base Deep Drawer	BDD
170	Base Drawer Range Top	BDRT
172	Base Lazy Susan	BLS
170	Base Microwave Cabinet	BMW
171	Base Full Height	BFH
171	Base Pullout	BPO
171	Base Tray	BT
171	Base Trash Cabinet	BTC
171	Base Trash Cabinet Full Height	BTCFH
173	Farm Sink Front	FSF
172	Sink Base	SB
173	Sink Base Full Height	SBFH
173	Sink Base Farm Sink	SBFS
173	Sink Base Full Height Removable Front - ADA	SBFHRF-ADA

Base Cabinets







Finished Side Charges

Description	Veneer Code
Base OR Vanity	BV34

Cabinet Modification Codes

364	Box Only (No Doors/Drawer Heads/Drawer Box/Hinges)
BNS	Box Only-No Fixed Shelf (No Doors/ Drawer Heads/ Drawer Box/Hinges/Fixed Shelf)
SCH	Soft-Close Adjustable Door Hinges
ETD	Euro Tech Drawer Box with Full Extension Soft-Close Glides
UPO	Mid Mounted Gray Laminated Pinned Pull-Out Tray, Soft-Close
2PO	Upper Pullout In-lieu of Fixed Shelf & Add Bottom Pullout
FTA	Feet Add-On
NFT	No Adjustable Feet
BOX	Box with No Doors or Drawer Heads

EURO Base Cabinetry: Cabinet Selection

Base Cabinets	Width	Height	Depth	Cabinet Doors	75 lb Glide Capacity Including Drawer	
Base (Single Door)						
	B12 L/R	12	34 1/2	24	◆ (1) DR1224 (1) DH1206	(1) Drawer
	B15 L/R	15	34 1/2	24	◆ (1) DR1524 (1) DH1506	(1) Fixed Half Shelf
	B18 L/R	18	34 1/2	24	◆ (1) DR1824 (1) DH1806	L/R designates hinging door
	B21 L/R	21	34 1/2	24	◆ (1) DR2124 (1) DH2106	
Base (Double Door)						
	B24	24	34 1/2	24	◆ (2) DR1224 (1) DH2406	(1) Drawer
	B27	27	34 1/2	24	◆ (2) DR1324 (1) DH2706	(1) Fixed Half Shelf
	B30	30	34 1/2	24	◆ (2) DR1524 (1) DH3006	
	B33	33	34 1/2	24	◆ (2) DR1624 (1) DH3306	
	B36	36	34 1/2	24	◆ (2) DR1824 (1) DH3606	
Base Drawer						
	BD12	12	34 1/2	24	◆ (1) DH1206 (2) DH1212	(1) Standard Upper Drawer
	BD15	15	34 1/2	24	◆ (1) DH1506 (2) DH1512	(2) Deep Lower Drawers
	BD18	18	34 1/2	24	◆ (1) DH1806 (2) DH1812	
	BD21	21	34 1/2	24	◆ (1) DH2106 (2) DH2112	
	BD24	24	34 1/2	24	◆ (1) DH2406 (2) DH2412	
	BD27	27	34 1/2	24	◆ (1) DH2706 (2) DH2712	
	BD30	30	34 1/2	24	◆ (1) DH3006 (2) DH3012	
	BD33	33	34 1/2	24	◆ (1) DH3306 (2) DH3312	
BD36	36	34 1/2	24	◆ (1) DH3606 (2) DH3612		
Base 4 Drawer						
	B4D12	12	34 1/2	24	◆ (3) DH1206 (1) DH1212	(3) Standard Upper Drawers
	B4D15	15	34 1/2	24	◆ (3) DH1506 (1) DH1512	(1) Deep Bottom Drawer
	B4D18	18	34 1/2	24	◆ (3) DH1806 (1) DH1812	
	B4D21	21	34 1/2	24	◆ (3) DH2106 (1) DH2112	
	B4D24	24	34 1/2	24	◆ (3) DH2406 (1) DH2412	
Base Deep Drawer						
	BDD24	24	34 1/2	24	◆ (2) DH2415	
	BDD27	27	34 1/2	24	◆ (2) DH2715	
	BDD30	30	34 1/2	24	◆ (2) DH3015	
	BDD33	33	34 1/2	24	◆ (2) DH3315	
	BDD36	36	34 1/2	24	◆ (2) DH3615	
Base Drawer Range Top						
	BDRT30	30	34 1/2	24	◆ (2) DH3012	Same as BD30 & BD36 but without top drawer
	BDRT36	36	34 1/2	24	◆ (2) DH3612	
Base Microwave Cabinet						
	BMW27-09	27	34 1/2	24	◆ (1) DH2709	Overlay Included with Base Microwave Cabinet
	BMW30-09	30	34 1/2	24	◆ (1) DH3009	

EURO Base Cabinetry: Cabinet Selection

Base Cabinets

		Width	Height	Depth	Cabinet Doors	
--	--	-------	--------	-------	---------------	--

Base Full Height (Single Door)



BFH12 L/R	12	34 1/2	24	◆ (1) DR1230	(1) Fixed Half Shelf
BFH15 L/R	15	34 1/2	24	◆ (1) DR1530	
BFH18 L/R	18	34 1/2	24	◆ (1) DR1830	
BFH21 L/R	21	34 1/2	24	◆ (1) DR2130	

Base Full Height (Double Door)

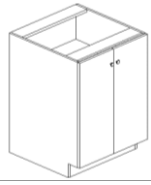

BFH24	24	34 1/2	24	◆ (2) DR1230	(1) Fixed Half Shelf
BFH27	27	34 1/2	24	◆ (2) DR1330	
BFH30	30	34 1/2	24	◆ (2) DR1530	
BFH33	33	34 1/2	24	◆ (2) DR1630	
BFH36	36	34 1/2	24	◆ (2) DR1830	

Base Pullout



BPO6	6	34 1/2	24	◆ (1) DR0630	(1) Door Top and Bottom Spice Racks are "fixed" Middle Spice Rack is Adjustable Soft Close Glides Not Available
BPO9	9	34 1/2	24	◆ (1) DR0930	
BPO12	12	34 1/2	24	◆ (1) DR1230	
BPO15	15	34 1/2	24	◆ (1) DR1530	
BPO18	18	34 1/2	24	◆ (1) DR1830	

Base Tray



BT6 L/R	6	34 1/2	24	◆ (1) DR0630	No Drawer or Pullout Tray
BT9 L/R	9	34 1/2	24	◆ (1) DR0930	
BT12 L/R	12	34 1/2	24	◆ (1) DR1230	

Base Trash Cabinet



BTC15	15	34 1/2	24	◆ (1) DR1524 (1) DH1506	(1) 35 Qt Bin (1) Standard Drawer Trash Can Unit Soft Close
BTC18	18	34 1/2	24	◆ (1) DR1824 (1) DH1806	(2) 35 Qt Bins (1) Standard Drawer Trash Can Unit Soft Close
BTC21	21	34 1/2	24	◆ (1) DR2124 (1) DH2106	Trash Can Unit Soft Close

Base Trash Cabinet Full Height



BTCFH15	15	34 1/2	24	◆ (1) DR1530	(1) 50 Qt Bin Trash Can Unit Soft Close
BTCFH18	18	34 1/2	24	◆ (1) DR1830	(2) 50 Qt Bins Trash Can Unit Soft Close
BTCFH21	21	34 1/2	24	◆ (1) DR2130	

Base Blind Corner



BBC42/45 L/R	36	34 1/2	24	◆ (1) DR1524 (1) DH1506	(1) Door (1) Drawer (1) Fixed Half Shelf 3" Corner Overlay Filler Included 6" Cover Overlay Attached Closure Panel for Blind Attached L/R designates position of blind side
BBC45/48 L/R	42	34 1/2	24	◆ (1) DR1824 (1) DH1806	
BBC48/51 L/R	48	34 1/2	24	◆ (1) DR2124 (1) DH2106	

Cabinet	Cabinet Width	Door Width	Minimum Pull	Maximum Pull
BBC42/45 L/R	36"	15"	42"	45"
BBC45/48 L/R	42"	18"	45"	48"
BBC48/51 L/R	48"	21"	48"	51"

EURO Base Cabinetry: Cabinet Selection

Base Cabinets

Width Height Depth Cabinet Doors

Base Blind Corner Full Height Swing Out

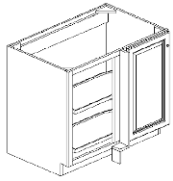

BBCFH504548 L/R	45	34 1/2	24	◆ (1) DR1830	(1) Door (2) Swing Out Shelves
BBCFH504851 L/R	48	34 1/2	24	◆ (1) DR2130	3" Corner Overlay Filler Included 6" Cover Overlay Attached L/R designates position of blind side

Base Blind Corner Swing Out



BBCSO45/48 L/R	42	34 1/2	24	◆ (1) DR1824 (1) DH1806	(1) Door (1) Drawer
BBCSO48/51 L/R	48	34 1/2	24	◆ (1) DR2124 (1) DH2106	(2) Swing-Out Shelves 3" Corner Overlay Filler Included 6" Cover Overlay Attached Closure Panel for Blind Attached L/R designates position of blind side

Cabinet	Cabinet Width	Door Width	Minimum Pull	Maximum Pull
BBCSO45/48 L/R	42"	18"	45"	48"
BBCSO48/51 L/R	48"	21"	48"	51"

Base Corner Shelf

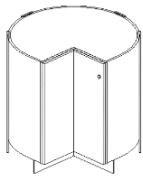

BCS33 L/R	33	34 1/2	24	◆ (2) DR0830	(1) Fixed Half Shelf Requires 33" in Each Direction
BCS36 L/R	36	34 1/2	24	◆ (2) DR1130	(1) Fixed Shelf Requires 36" in Each Direction

Use Code for Replacement
CD- Cabinet to Door OR Code DD- Door to Door

Base Lazy Susan

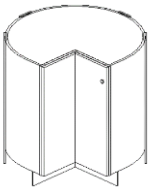

BLS33 L/R	33	34 1/2	24	◆ (2) DR0830	(2) Pie Cut Shelves that Rotate Independently Requires 33" in Each Direction 33" Tray Diameter = 25 3/4"
BLS36 L/R	36	34 1/2	24	◆ (2) DR1130	(2) Pie Cut Shelves that Rotate Independently Requires 36" in Each Direction 36" Tray Diameter = 27 1/8"

Use Code for Replacement
CD- Cabinet to Door OR Code DD- Door to Door

Sink Base (Single Door)

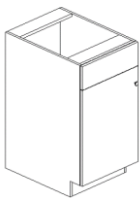

SB18 L/R	18	34 1/2	24	◆ (1) DR1824 (1) DH1806	Vertical Construction Braces
SB21 L/R	21	34 1/2	24	◆ (1) DR2124 (1) DH2106	

Sink Base (Double Door)



SB24	24	34 1/2	24	◆ (2) DR1224 (1) DH2406	Vertical Construction Braces
SB27	27	34 1/2	24	◆ (2) DR1324 (1) DH2706	
SB30	30	34 1/2	24	◆ (2) DR1524 (1) DH3006	
SB33	33	34 1/2	24	◆ (2) DR1624 (1) DH3306	
SB36	36	34 1/2	24	◆ (2) DR1824 (1) DH3606	

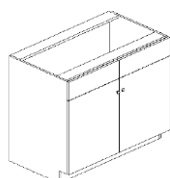

SB42	42	34 1/2	24	◆ (2) DR2124 (2) DH2106	Vertical Construction Braces
-------------	----	--------	----	-------------------------	------------------------------

EURO Base Cabinetry: Cabinet Selection

Base Cabinets

		Width	Height	Depth	Cabinet Doors	
--	--	-------	--------	-------	---------------	--

Sink Base Full Height (Single Door)



SBFH18 L/R	18	34 1/2	24	◆ (1) DR1830	(1) Full Height Door Vertical Construction Braces
SBFH21 L/R	21	34 1/2	24	◆ (1) DR2130	

Sink Base Full Height (Double Door)



SBFH24	24	34 1/2	24	◆ (2) DR1230	(2) Full Height Doors Vertical Construction Braces
SBFH27	27	34 1/2	24	◆ (2) DR1330	
SBFH30	30	34 1/2	24	◆ (2) DR1530	
SBFH33	33	34 1/2	24	◆ (2) DR1630	
SBFH36	36	34 1/2	24	◆ (2) DR1830	
SBFH42	42	34 1/2	24	◆ (2) DR2130	

Sink Base Farm Sink

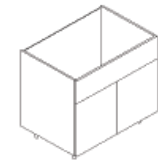

SBFS36	36	34 1/2	30	◆ (2) DR1821	
---------------	----	--------	----	--------------	--

Farm Sink Front



FSF3609	35 7/8	8 7/8	3/4		
----------------	--------	-------	-----	--	--

Base Cooktop

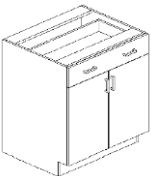

BCT30	30	34 1/2	24	◆ (2) DR1524 (1) DH3006	Vanity depth drawer to allow for mechanicals
BCT36	36	34 1/2	24	◆ (2) DR1624 (1) DH3306	Drawer Depth is 18"

Base Drawer Cooktop



BDCT30	30	34 1/2	24	◆ (1) DH3006 (2) DH3011	Vanity depth drawer to allow for mechanicals
BDCT36	36	34 1/2	24	◆ (1) DH3606 (2) DH3611	Drawer Depth is 18"

Sink Base Full Height Removable Front - ADA

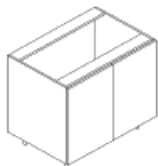

SBFH33-ADA	33	32 1/2	24	◆ (2) DR1628.5	
SBFH36-ADA	36	32 1/2	24	◆ (2) DR1828.5	

Base Drawer - ADA

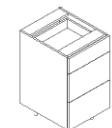

BD12-ADA	12	32 1/2	24	◆ (1) DR1206 (1) DH1210.5 (1) DH1212	
BD15-ADA	15	32 1/2	24	◆ (1) DR1506 (1) DH1510.5 (1) DH1512	
BD18-ADA	18	32 1/2	24	◆ (1) DR1806 (1) DH1810.5 (1) DH1812	
BD21-ADA	21	32 1/2	24	◆ (1) DR2106 (1) DH2110.5 (1) DH2112	

TAB: EURO Tall Cabinetry

- *Index*
- *Construction Options & Modifications Key*
- *Cabinet Selection*

EURO Tall Cabinetry

Page Location	Cabinet Type	Nomenclature
176	Construction Options & Modifications Key	
178	Oven Cabinets - Double	OC
178	Oven Cabinets - Single	OC
177	Utility Cabinets 12" Depth	UC
177	Utility Cabinets 24" Depth	UC

Tall Cabinets

Finished Side Charges	
Description	Veneer Code
84" High - Taller	BV84
90" High - Taller	BV90
96" High - Taller	BV96

Cabinet Modification Codes	
364	Box Only (No Doors/Drawer Heads/Drawer Box/Hinges)
SCH	Soft-Close Adjustable Door Hinges
ETD	Euro Tech Drawer Box with Full Extension Soft-Close Glides
FTA	Feet Add-On
NFT	No Adjustable Feet
BOX	Box with No Doors or Drawer Heads

EURO Tall Cabinetry: Cabinet Selection

Note: All Utility Cabinets Must be Ordered with Either Full Depth Shelf Kits or Pull-Out Trays*

Tall Cabinets

Utility Cabinet (12" Deep) - Height 84"

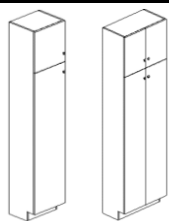

	Width	Height	Depth	Cabinet Doors
UC1584 L/R	15	84	12	◆ (1) DR1518 (1) DR1562
UC1884 L/R	18	84	12	◆ (1) DR1818 (1) DR1862
UC2484	24	84	12	◆ (2) DR1218 (2) DR1262
UC3084	30	84	12	◆ (2) DR1518 (2) DR1562

No Shelf in Upper Section
Pantry Shelf Kits (PSK) sold separately

L/R designates hinging door

Utility Cabinet (12" Deep) - Height 90"

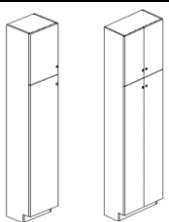

UC1590 L/R	15	90	12	◆ (1) DR1524 (1) DR1562
UC1890 L/R	18	90	12	◆ (1) DR1824 (1) DR1862
UC2490	24	90	12	◆ (2) DR1262 (2) DR1224
UC3090	30	90	12	◆ (2) DR1562 (2) DR1524

(1) Adjustable Shelf in Upper Section
Pantry Shelf Kits (PSK) sold separately

Utility Cabinet (12" Deep) - Height 96"

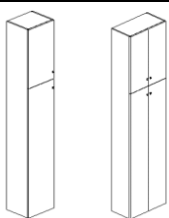

UC1596 L/R	15	96	12	◆ (1) DR1530 (1) DR1562
UC1896 L/R	18	96	12	◆ (1) DR1830 (1) DR1862
UC2496	24	96	12	◆ (2) DR1262 (2) DR1230
UC3096	30	96	12	◆ (2) DR1562 (2) DR1530

(2) Adjustable Shelves in Upper Section
Pantry Shelf Kits (PSK) sold separately

Utility Cabinet (24" Deep) - Height 84"

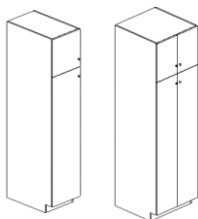

UC158424 L/R	15	84	24	◆ (1) DR1562 (1) DR1518
UC188424 L/R	18	84	24	◆ (1) DR1862 (1) DR1818
UC248424	24	84	24	◆ (2) DR1262 (2) DR1218
UC308424	30	84	24	◆ (2) DR1562 (2) DR1518

No Shelf in Upper Section
(1) Full Depth Fixed Shelf in Bottom Section
Full Depth Shelf Kits (FDSK) Sold Separately
Pullout Tray Kits (POT) Sold Separately

Utility Cabinet (24" Deep) - Height 90"

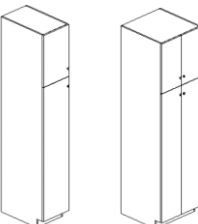

UC159024 L/R	15	90	24	◆ (1) DR1562 (1) DR1524
UC189024 L/R	18	90	24	◆ (1) DR1862 (1) DR1824
UC249024	24	90	24	◆ (2) DR1262 (2) DR1224
UC309024	30	90	24	◆ (2) DR1562 (2) DR1524

(1) Adjustable Shelf in Upper Section
(1) Full Depth Fixed Shelf in Bottom Section
Full Depth Shelf Kits (FDSK) Sold Separately
Pullout Tray Kits (POT) Sold Separately

Utility Cabinet (24" Deep) - Height 96"

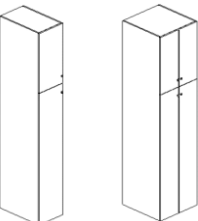

UC159624 L/R	15	96	24	◆ (1) DR1562 (1) DR1530
UC189624 L/R	18	96	24	◆ (1) DR1862 (1) DR1830
UC249624	24	96	24	◆ (2) DR1262 (2) DR1230
UC309624	30	96	24	◆ (2) DR1562 (2) DR1530

(2) Adjustable Shelves in Upper Section
(1) Full Depth Midshelf in Bottom Section
Full Depth Shelf Kits (FDSK) Sold Separately
Pullout Tray Kits (POT) Sold Separately

EURO Tall Cabinetry: Cabinet Selection

Tall Cabinets

Width Height Depth

Cabinet Doors

Oven Cabinet (Single) - Height 84"

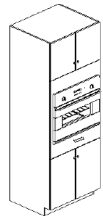

OC3084S	30	84	24	◆ (2) DR1518 (2) DR1524 (1) DH3006
OC3384S	33	84	24	◆ (2) DR1618 (2) DR1624 (1) DH3306

(2) Doors Above
No Shelf in Upper Section
(1) Middle Drawer
(2) Doors Below
(1) Half Depth Shelf in Bottom Section
(1) 24" deep shelf included for oven installation
OTFK included

Oven Cabinet (Single) - Height 90"

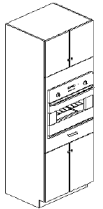

OC3090S	30	90	24	◆ (4) DR1524 (1) DH3006
OC3390S	33	90	24	◆ (4) DR1624 (1) DH3306

(2) Doors Above
(1) Adjustable Shelf in Upper Section
(1) Middle Drawer
(2) Doors Below
(1) Half Depth Shelf in Bottom Section
(1) 24" deep shelf included for oven installation
OTFK included

Oven Cabinet (Single) - Height 96"

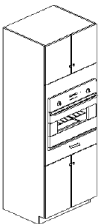

OC3096S	30	96	24	◆ (2) DR1530 (2) DR1524 (1) DH3006
OC3396S	33	96	24	◆ (2) DR1630 (2) DR1624 (1) DH3306

(2) Doors Above
(1) Adjustable Shelf in Upper Section
(1) Middle Drawer
(2) Doors Below
(1) Half Depth Shelf in Bottom Section
(1) 24" deep shelf included for oven installation
OTFK included

Oven Cabinet (Double) - Height 84"

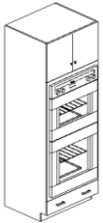

OC3084L	30	84	24	◆ (2) DR1518 (1) DH3006
OC3384L	33	84	24	◆ (2) DR1618 (1) DH3306

(2) Doors Above
No Shelf in Upper Section
(1) Drawer Below
(1) 24" deep shelf included for oven installation
OTFK included

Oven Cabinet (Double) - Height 90"

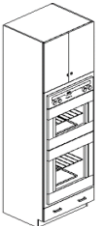

OC3090L	30	90	24	◆ (2) DR1524 (1) DH3006
OC3390L	33	90	24	◆ (2) DR1624 (1) DH3306

(2) Doors Above
(1) Adjustable Shelf in Upper Section
(1) Drawer Below
(1) 24" deep shelf included for oven installation
OTFK included

Oven Cabinet (Double) - Height 96"

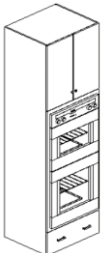

OC3096L	30	96	24	◆ (2) DR1530 (1) DH3006
OC3396L	33	96	24	◆ (2) DR1630 (1) DH3306

(2) Doors Above
(1) Adjustable Shelf in Upper Section
(1) Drawer Below
(1) 24" deep shelf included for oven installation
OTFK included

TAB: EURO Vanity & Office Cabinetry

- *Index*
- *Construction Options & Modifications Key*
- *Cabinet Selection*

EURO Vanity & Office Cabinetry

Page Location	Cabinet Type	Nomenclature
181	Construction Options & Modifications Key	
184	Apron Drawer	AD
184	Deep Desk File	DDF
184	Desk File	DF
182	Vanity Base	VB
182	Vanity Base Drawer	VBD
182	Vanity Base Space Saver	VBS
182	Vanity 1 Drawer	V1D
183	Vanity Drawer	VD
183	Vanity 4 Drawer	V4D
183	Vanity Linen	VL
183	Vanity Sink Base	VSB
183	Vanity Drawer - ADA	VD-ADA
183	Vanity Base Removable Front - ADA	VBRF-ADA
183	Vanity Sink Base Removable Front - ADA	VSB-HV-ADA
183	Hanging Apron Vanity Front	HAVF

Vanity/Office Cabinets

Finished Side Charges

Description	Veneer Code
Base OR Vanity	BV34

Cabinet Modification Codes

364	Box Only (No Doors/Drawer Heads/Drawer Box/Hinges)
SCH	Soft-Close Adjustable Door Hinges
ETD	Euro Tech Drawer Box with Full Extension Soft-Close Glides
UPO	Mid Mounted Gray Laminated Pinned Pull-Out Tray, Soft-Close
2PO	Bottom Mounted Gray Laminated Pinned Pull-Out Tray, Soft-Close
FTA	Feet Add-On
NFT	No Adjustable Feet

EURO Vanity & Office Cabinetry: Cabinet Selection

Vanity Cabinets

		Width	Height	Depth	Cabinet Doors
--	--	-------	--------	-------	---------------

Vanity Base (Single Door)

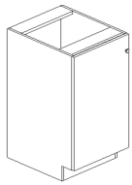

VB15 L/R	15	34 1/2	21	◆ (1) DR1530
VB18 L/R	18	34 1/2	21	◆ (1) DR1830
VB21 L/R	21	34 1/2	21	◆ (1) DR2130

Vanity Base (Double Door)



VB24	24	34 1/2	21	◆ (2) DR1230
VB27	27	34 1/2	21	◆ (2) DR1330
VB30	30	34 1/2	21	◆ (2) DR1530
VB33	33	34 1/2	21	◆ (2) DR1630
VB36	36	34 1/2	21	◆ (2) DR1830
VB42	42	34 1/2	21	◆ (2) DR2130
VB48	48	34 1/2	21	◆ (2) DR2430

Vanity Base Drawer



VBD30 L/R	30	34 1/2	21	◆ (1) DR1830 (1) DH1206 (2) DH1212
VBD33 L/R	33	34 1/2	21	◆ (1) DR1830 (1) DH1506 (2) DH1512
VBD36 L/R	36	34 1/2	21	◆ (1) DR2130 (1) DH1506 (2) DH1512
VBD39 L/R	39	34 1/2	21	◆ (1) DR2130 (1) DH1806 (2) DH1812

Top drawer front non-operational

Note: False Upper Drawer Head with (2) Deep Drawers

Vanity Base Drawer - 3 Door



VBD42	42	34 1/2	21	◆ (2) DR1224 (1) DR1830 (2) DH1206
VBD48	48	34 1/2	21	◆ (2) DR1524 (1) DR1830 (2) DH1506

Middle Door is Always Hinged Left

Vanity Base Space Saver

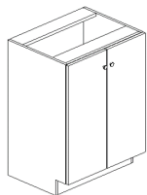

VBS24	24	34 1/2	18	◆ (2) DR1230
VBS30	30	34 1/2	18	◆ (2) DR1530
VBS33	33	34 1/2	18	◆ (2) DR1630
VBS36	36	34 1/2	18	◆ (2) DR1830

Vanity 1 Drawer

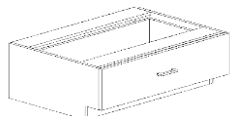

V1D18	18	16	21	◆ (1) DH1812
V1D21	21	16	21	◆ (1) DH2112
V1D24	24	16	21	◆ (1) DH2412
V1D27	27	16	21	◆ (1) DH2712
V1D30	30	16	21	◆ (1) DH3012
V1D33	33	16	21	◆ (1) DH3312
V1D36	36	16	21	◆ (1) DH3612

EURO Vanity & Office Cabinetry: Cabinet Selection

Vanity Cabinets

	Width	Height	Depth	Cabinet Doors		
Vanity Drawer						
	VD12	12	34 1/2	21	◆ (1) DH1206 (2) DH1212	(1) Standard Drawer (2) Deep Drawers
	VD15	15	34 1/2	21	◆ (1) DH1506 (2) DH1512	
	VD18	18	34 1/2	21	◆ (1) DH1806 (2) DH1812	
	VD21	21	34 1/2	21	◆ (1) DH2106 (2) DH2112	
	VD24	24	34 1/2	21	◆ (1) DH2406 (2) DH2412	
	VD27	27	34 1/2	21	◆ (1) DH2706 (2) DH2712	
	VD30	30	34 1/2	21	◆ (1) DH3006 (2) DH3012	

Vanity 4 Drawer						
	V4D12	12	34 1/2	21	◆ (3) DH1206 (1) DH1212	(3) Standard Upper Drawers (1) Deep Lower Drawer
	V4D15	15	34 1/2	21	◆ (3) DH1506 (1) DH1512	
	V4D18	18	34 1/2	21	◆ (3) DH1806 (1) DH1812	
	V4D21	21	34 1/2	21	◆ (3) DH2106 (1) DH2112	
	V4D24	24	34 1/2	21	◆ (3) DH2406 (1) DH2412	

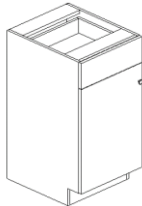
Vanity Sink Base						
	VS18 L/R	18	34 1/2	21	◆ (1) DR1824 (1) DH1806	
	VS21 L/R	21	34 1/2	21	◆ (1) DR2124 (1) DH2106	
	VS24 L/R	24	34 1/2	21	◆ (2) DR1224 (1) DH2406	
	VS27 L/R	27	34 1/2	21	◆ (2) DR1324 (1) DH2706	
	VS30 L/R	30	34 1/2	21	◆ (2) DR1524 (1) DH3006	
	VS33 L/R	33	34 1/2	21	◆ (2) DR1624 (1) DH3306	
	VS36 L/R	36	34 1/2	21	◆ (2) DR1824 (1) DH3606	

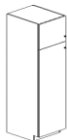
Vanity Linen						
	VL188421 L/R	18	84	21	◆ (1) DR1862 (1) DR1818	Includes 4 Adjustable Shelves

Vanity Base Removable Front - ADA						
	VBRF33-ADA	33	32 1/2	21	◆ (2) DR1628.5	
	VBRF36-ADA	36	32 1/2	21	◆ (2) DR1828.5	

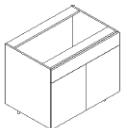
Vanity Sink Base - Hanging Vanity - ADA						
	VS33-HV-ADA	33	32 1/2	21	◆ (1) DH3304.5 (2) DR1624	Can be used alone or with HAVF for later conversion
	VS36-HV-ADA	36	32 1/2	21	◆ (1) DH3604.5 (2) DR1824	

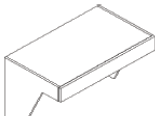
Hanging Apron Vanity Front						
	HAVF3321	28 1/2	21	19 3/4		Can be used alone or with VSB-HV-ADA - Vanity Sink Base - Hanging Vanity - ADA
	HAVF3621	31 1/2	21	19 3/4		

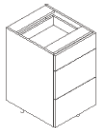
Vanity Drawer - ADA						
	VD12-ADA	12	32 1/2	21	◆ (1) DH1206 (1) DH1210.5 (1) DH1212	
	VD15-ADA	15	32 1/2	21	◆ (1) DH1506 (1) DH1510.5 (1) DH1512	
	VD18-ADA	18	32 1/2	21	◆ (1) DH1806 (1) DH1810.5 (1) DH1812	
	VD21-ADA	21	32 1/2	21	◆ (1) DH2106 (1) DH2110.5 (1) DH2112	

EURO Vanity & Office Cabinetry: Cabinet Selection

Office Cabinets

Width Height Depth

Cabinet Doors

Apron Drawer

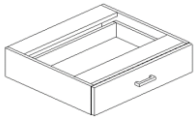

AD24	24	5 1/2	21	◆ (1) DH2405.5
AD30	30	5 1/2	21	◆ (1) DH3005.5
AD36	36	5 1/2	21	◆ (1) DH3605.5

Deep Desk File



DDF1529	15	29 1/2	21	◆ (2) DH1513	Drawers Hold File Folders
DDF1829	18	29 1/2	21	◆ (2) DH1813	
DDF3029	30	29 1/2	21	◆ (2) DH3013	
DDF3629	36	29 1/2	21	◆ (2) DH3613	

Desk File



DF1529	15	29 1/2	21	◆ (1) DH1505.5 (1) DH1506 (1) DH1513	Bottom Drawer Holds Files
DF1829	18	29 1/2	21	◆ (1) DH1805.5 (1) DH1806 (1) DH1813	

TAB: EURO Fillers, Panels &
Moldings

- *Index*
- *Fillers*
- *End Panels*
- *Moldings*

EURO Fillers & Panels

Page located	Cabinet Type	Nomenclature
188	Alumasteel Filler	F-ALMSTL
188	Alumasteel Liner	ALMSTL
187	Corner Filler	CF
187	End Filler Flat	EFF
187	End Filler Flat with Return	EFF-R
188	End Panel	EP
187	Flat Filler	F
189	Floating Shelf	FLSH
189	Furniture Toe Kick	FTK
188	Laminate Sheet	LAMINATE
187	Overlay Filler	F-OL
188	Panel Backer	PB
189	Scribe	SS
189	SHOE	SHOE
187	Starter Filler	F
188	Toe Kick Cover	TKC

EURO Fillers & Panels

Fillers & Panels

Width Height Depth

** Long Edges are Finished on all Fillers**

Corner Filler

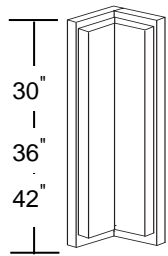

CF3/30-OL	3	30	3
CF3/36-OL	3	36	3
CF3/42-OL	3	42	3
CF3/48-OL	3	48	3



End Filler



EFF34	3	34 1/2	24 3/4
EFF96	3	96	24 3/4

Flat Filler

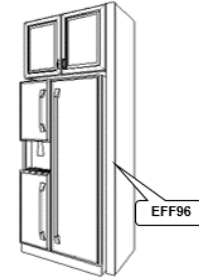
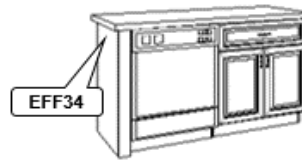

End Filler with Return

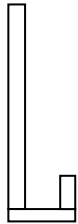

EFF34-R	3	34 1/2	24 3/4
EFF96-R	3	96	24 3/4

Flat Filler

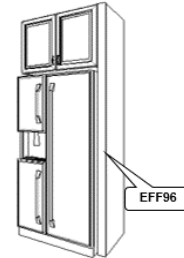
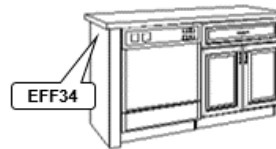

Flat Filler

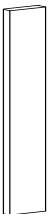

F3/96	3	96	3/4
F6/96	6	96	3/4

Note: Use F3/96 horizontally for light shield molding*

Overlay Filler

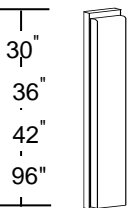

F3/30-OL	3	30	1 1/2
F3/36-OL	3	36	1 1/2
F3/42-OL	3	42	1 1/2
F3/96-OL	3	96	1 1/2

Starter Filler

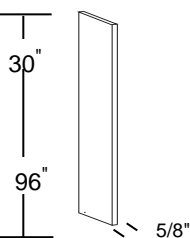

F58/30	5/8	30	4
F58/96	5/8	96	4

EURO Fillers & Panels

Fillers & Panels

Width Height Depth

Alumasteel Filler

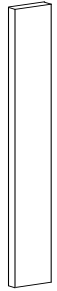

F3/30-ALMSTL	30 ^{9/16}	3	3/4
F3/36-ALMSTL	36	3	3/4
F3/48-ALMSTL	48	3	3/4

Panel Backer

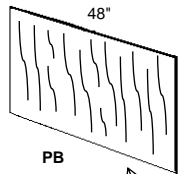

PB34	48	34 ^{1/2}	5/8
PB48	48	48	5/8

Grain runs vertical

Note: PB has finished edges

Toe Kick Cover

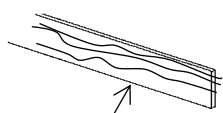

TKC8	4 ^{1/2}	96	5/8
------	------------------	----	-----

Grain runs horizontal

Note: TKC8 does not have finished edges

End Panel

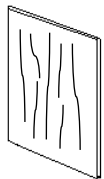

EP34	24 ^{3/4}	34 ^{1/2}	3/4
EP96	24 ^{3/4}	96	3/4
EP3096	30	96	3/4

Grain

End Panel (Skin)

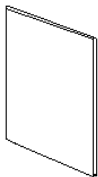

EPB34	24	30	1/32
EPW42	12	42	1/32

Laminate Sheets

LAMINATE 4x8	48	96	1/32	Cut to size in field
--------------	----	----	------	----------------------

Alumasteel Liner



ALMSTL3624	36	24
ALMSTL4824	48	24
ALMSTL6024	60	24

EURO Moldings

Moldings

Width Height Depth

Furniture Toe Kick

FTK8

4 ⁵/₈ 96 3/4

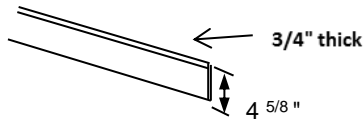

FTK8 comes in matching Euro Color

SHOE

SHOE8

5/8" 96 1/2"



Scribe

SS8

5/8 96 1/4

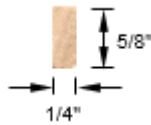

SS8 comes in complimentary color

Floating Shelf

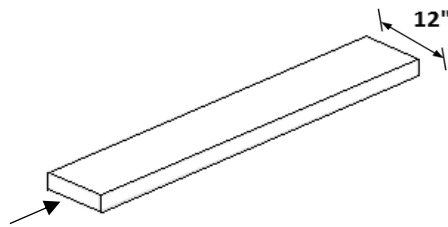

3" thick

****Maximum 50 lb. weight limit**

****Approximately 4"- 6" spacing perpendicular support included**

FLSH18
 FLSH21
 FLSH24
 FLSH27
 FLSH30
 FLSH33
 FLSH36
 FLSH42
 FLSH48
 FLSH54
 FLSH60
 FLSH66
 FLSH72

TAB: EURO Accessories

- *Index*
- *Standard & Upgraded Hardware*
- *Cutlery Tray Inserts*

Accessories

Page Location	Item Type	Nomenclature
192	Standard and Upgraded Hardware	HWD
193	Upgraded 2 Hardware	HWD
194	Cutlery Tray Insert	CT

Accessories: Standard and Upgraded Hardware

STANDARD HARDWARE



UPGRADED HARDWARE



UPGRADED 2 HARDWARE



TK857BSN



TK857AG



TK857BLK



TK857HB



TK909BSN



TK909AG



TK909BLK



TK909HB



TK708BSN



TK708AG



TK708BLK



TK708HB



TK946BSN



TK946AG



TK946BLK



TK946HB



TK888BSN



TK888AG



TK888BLK



TK888HB

EURO Accessories: Cutlery Drawer Inserts

NOTE: THESE TRAYS ARE SOLD AS AN INDIVIDUAL LINE ITEM. FINISH ON CUTLERY DRAWER INSERTS ARE GRAY.
IMPORTANT: THE DRAWER CORE MUST BE UPGRADED TO EUROTEC DRAWER CORES FOR THESE INSERTS TO FIT PROPERLY.

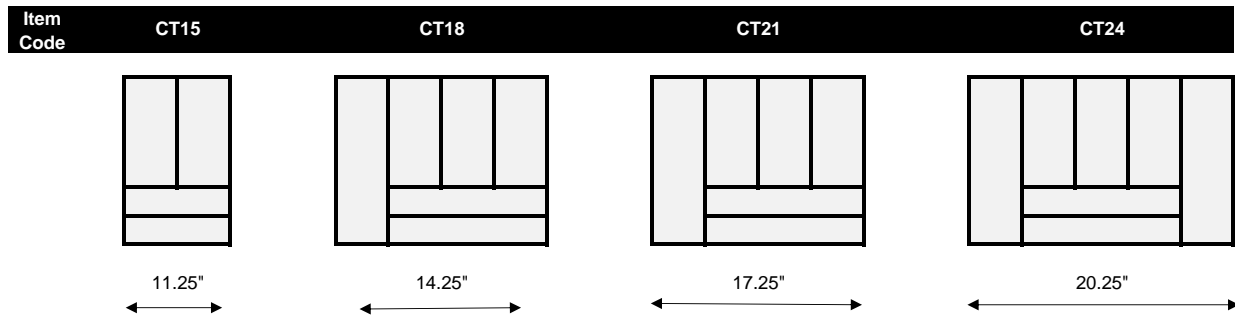

TAB: EURO Replacement Items

EURO Replacement Items

- ***Index***
- ***Sample Doors & Color Blocks***
- ***Doors & Drawer Heads***
- ***Glass Doors***
- ***Standard Drawers***
- ***Euro Tech Drawers***
- ***Pull Outs & Shelving***
- ***Trim Kits***

EURO Replacement Items

Page Location	Item Type	Nomenclature
199	Doors	DR
199	Drawer Heads	DH
200	Glass Doors	DRG
203	Full Depth Shelf Kits	FDSK
197	Non-Soft Close Hinge (GHS)	HINGE-EUR
197	Soft Close Hinge (CHS)	HINGE-EUR-SC
197	Utility w/ RO & BLS Non-Soft Close Hinge	HINGE-UCR
197	Utility w/ RO Soft-Close Hinge	HINGE-UCR-SC
197	Utility w/ SH Non-Soft Close Hinge	HINGE-UCS
197	Utility w/ SH Soft-Close Hinge	HINGE-UCS-SC
205	Oven Trim Kit Full	OTKF
204	Pullout Tray Kits	POT/POTC
202	Drawer Kits	RDK
203	Euro Tech Drawer Kits	RDKM
204	Pullouts	RPK
204	Shelves	SH
197	21D Base Trash Can Glides	SMG21-BTC
204	Spice Pullouts	SPICE-RACK
204	Trash Can	TRASH-CAN
204	Wall Corner Shelves	WCSH/SPCSH
204	Pantry Shelf Kit	PSK

Replacement Items: Miscellaneous

Miscellaneous Items

Hinge and Glides	
HINGE-EUR	Non-Soft Close Hinge
HINGE-EUR-SC	Soft Close Hinge
HINGE-UCR	Utility w/ RO & BLS Non-Soft Close Hinge
HINGE-UCR-SC	Utility w/ RO Soft-Close Hinge
HINGE-UCS	Utility w/ SH Non-Soft Close Hinge
HINGE-UCS-SC	Utility w/ SH Soft-Close Hinge
SMG21-BTC	21D Base Trash Can Glides

EURO Replacement Items: Door Hinge Drilling Guide

Door Hinge Drilling Information for EURO

When ordering replacement doors, it is important to know the following:

1. All doors up to and including 42" high receive 2 hinge drillings.
2. All doors 48" and higher receive 3 hinge drillings.
3. Hinges do not come with replacement doors. If you need additional hinges, they must be ordered separately as a "REPLACEMENT" item.
Be sure to specify the type of cabinet the manufacturer in the REPLACEMENT item detail screen to ensure you receive the correct hinges

EURO Replacement Items: Doors & Drawer Heads

Doors & Drawer Heads

Doors				Drawer Heads								
	Door Code	Width	Height		Door Code	Width	Height		Drawer Head Code	Width	Height	
12	DR1212	11 ^{7/8}	11 ^{3/4}	48	DR1548	14 ^{7/8}	47 ^{3/4}	4.5	DH3304.5	32 ^{7/8}	4 ^{7/16}	
	DR1512	14 ^{7/8}	11 ^{3/4}		DR1848	17 ^{7/8}	47 ^{3/4}		DH3604.5	35 ^{7/8}	4 ^{7/16}	
	DR1612	16 ^{3/8}	11 ^{3/4}		54	DR1554	14 ^{7/8}	53 ^{3/4}	5.5	DH1505.5	14 ^{7/8}	5 ^{1/4}
	DR1812	17 ^{7/8}	11 ^{3/4}	DR1854		17 ^{7/8}	53 ^{3/4}	DH1805.5		17 ^{7/8}	5 ^{1/4}	
	DR2112	20 ^{7/8}	11 ^{3/4}	62	DR1262	11 ^{7/8}	61 ^{3/4}	DH2405.5		23 ^{7/8}	5 ^{1/4}	
15	DR1515	14 ^{7/8}	14 ^{3/4}		DR1562	14 ^{7/8}	61 ^{3/4}	DH3005.5	29 ^{7/8}	5 ^{1/4}		
	DR1615	16 ^{3/8}	14 ^{3/4}		DR1862	17 ^{7/8}	61 ^{3/4}	DH3605.5	35 ^{7/8}	5 ^{1/4}		
	DR1815	17 ^{7/8}	14 ^{3/4}	6	DH1206	11 ^{7/8}	5 ^{3/4}	DH1506	14 ^{7/8}	5 ^{3/4}		
18	DR1118	10 ^{15/16}	17 ^{3/4}		DH15.506	15 ^{5/8}	5 ^{3/4}	DH1806	17 ^{7/8}	5 ^{3/4}		
	DR1218	11 ^{7/8}	17 ^{3/4}		DH2106	20 ^{7/8}	5 ^{3/4}	DH2406	23 ^{7/8}	5 ^{3/4}		
	DR1318	13 ^{3/8}	17 ^{3/4}		DH2706	26 ^{7/8}	5 ^{3/4}	DH3006	29 ^{7/8}	5 ^{3/4}		
	DR1518	14 ^{7/8}	17 ^{3/4}		DH3306	32 ^{7/8}	5 ^{3/4}	DH3606	35 ^{7/8}	5 ^{3/4}		
	DR15.518	15 ^{15/16}	17 ^{3/4}		7	DH1507	14 ^{7/8}	6 ^{3/4}	DH1807	17 ^{7/8}	6 ^{3/4}	
	DR1618	16 ^{3/8}	17 ^{3/4}			9	DH2709	26 ^{7/8}	9	DH3009	29 ^{7/8}	9
	DR1818	17 ^{7/8}	17 ^{3/4}		10.5		DH1210.5	11 ^{7/8}	10 ^{3/8}	DH1510.5	15 ^{7/8}	10 ^{3/8}
	DR2118	20 ^{7/8}	17 ^{3/4}			DH1810.5	17 ^{7/8}	10 ^{3/8}	DH2110.5	20 ^{7/8}	10 ^{3/8}	
	DR2418	23 ^{7/8}	17 ^{3/4}			12	DH1212	11 ^{7/8}	11 ^{3/4}	DH1512	14 ^{7/8}	11 ^{3/4}
	DR3018	29 ^{7/8}	17 ^{3/4}		DH1812		17 ^{7/8}	11 ^{3/4}	DH2112	20 ^{7/8}	11 ^{3/4}	
	DR3618	35 ^{7/8}	17 ^{3/4}		DH2412		23 ^{7/8}	11 ^{3/4}	DH2712	26 ^{7/8}	11 ^{3/4}	
21	DR1821	17 ^{7/8}	20 ^{3/4}		DH3012		29 ^{7/8}	11 ^{3/4}	DH3312	32 ^{7/8}	11 ^{3/4}	
	24	DR1224	11 ^{7/8}	23 ^{3/4}	DH3612		35 ^{7/8}	11 ^{3/4}	13	DH1513	14 ^{7/8}	12 ^{3/4}
DR1324		13 ^{3/8}	23 ^{3/4}	DH1813	17 ^{7/8}	12 ^{3/4}	DH3013	29 ^{7/8}		12 ^{3/4}		
DR1524		14 ^{7/8}	23 ^{3/4}	DH3613	35 ^{7/8}	12 ^{3/4}	15	DH2415		23 ^{7/8}	12 ^{3/4}	
DR15.524		15 ^{15/16}	23 ^{3/4}	13	DH1515	14 ^{7/8}		12 ^{3/4}		DH2715	26 ^{7/8}	12 ^{3/4}
DR1624		16 ^{3/8}	23 ^{3/4}		DH1815	17 ^{7/8}		12 ^{3/4}		DH3015	29 ^{7/8}	12 ^{3/4}
DR1824		17 ^{7/8}	23 ^{3/4}	15	DH3615	35 ^{7/8}	12 ^{3/4}	DH3315	32 ^{7/8}	12 ^{3/4}		
DR2124		20 ^{7/8}	23 ^{3/4}		DH2415	23 ^{7/8}	12 ^{3/4}	DH2715	26 ^{7/8}	12 ^{3/4}		
DR2424	23 ^{3/4}	23 ^{3/4}		DH3015	29 ^{7/8}	12 ^{3/4}	DH3315	32 ^{7/8}	12 ^{3/4}			
28.5	DR1628.5	16 ^{3/8}	28 ^{13/32}		DH3615	35 ^{7/8}	12 ^{3/4}					
	DR1828.5	17 ^{7/8}	28 ^{13/32}									
30	DR0630	5 ^{7/8}	29 ^{3/4}									
	DR0830	7 ^{15/16}	29 ^{3/4}									
	DR0930	8 ^{7/8}	29 ^{3/4}									
	DR1130	10 ^{15/16}	29 ^{3/4}									
	DR1230	11 ^{7/8}	29 ^{3/4}									
	DR1330	13 ^{3/8}	29 ^{3/4}									
	DR1530	14 ^{7/8}	29 ^{3/4}									
	DR15.530	15 ^{15/16}	29 ^{3/4}									
	DR1630	16 ^{3/8}	29 ^{3/4}									
	DR1830	17 ^{7/8}	29 ^{3/4}									
	DR2130	20 ^{7/8}	29 ^{3/4}									
	DR2430	23 ^{7/8}	29 ^{3/4}									
	36	DR0936	8 ^{7/8}	35 ^{3/4}								
DR1136		10 ^{15/16}	35 ^{3/4}									
DR1236		11 ^{7/8}	35 ^{3/4}									
DR1336		13 ^{3/8}	35 ^{3/4}									
DR1536		14 ^{7/8}	35 ^{3/4}									
DR15.536		15 ^{15/16}	35 ^{3/4}									
DR1636		16 ^{3/8}	35 ^{3/4}									
DR1836		17 ^{7/8}	35 ^{3/4}									
DR2136		20 ^{7/8}	35 ^{3/4}									
DR2436	23 ^{3/4}	35 ^{3/4}										
42	DR0942	8 ^{7/8}	41 ^{3/4}									
	DR1142	10 ^{15/16}	41 ^{3/4}									
	DR1242	11 ^{7/8}	41 ^{3/4}									
	DR1342	13 ^{7/8}	41 ^{3/4}									
	DR1542	14 ^{7/8}	41 ^{3/4}									
	DR15.542	15 ^{15/16}	41 ^{3/4}									
	DR1642	16 ^{3/8}	41 ^{3/4}									
	DR1842	17 ^{7/8}	41 ^{3/4}									
	DR2142	20 ^{7/8}	41 ^{3/4}									
DR2442	23 ^{3/4}	41 ^{3/4}										

EURO Replacement Items: Glass Doors

Glass Doors

	Glass Door Code	Width	Height
15	DRG1515	14 ⁷ / ₈	14 ³ / ₄
	DRG1815	17 ⁷ / ₈	14 ³ / ₄
18	DRG1118	10 ⁷ / ₈	17 ³ / ₄
	DRG1218	11 ⁷ / ₈	17 ³ / ₄
	DRG1318	13 ³ / ₈	17 ³ / ₄
	DRG1518	14 ⁷ / ₈	17 ³ / ₄
	DRG15.518	15 ¹⁵ / ₁₆	17 ³ / ₄
	DRG1618	16 ³ / ₈	17 ³ / ₄
	DRG1818	17 ⁷ / ₈	17 ³ / ₄
	DRG2118	20 ⁷ / ₈	17 ³ / ₄
	DRG2418	23 ⁷ / ₈	17 ³ / ₄
	DRG3018	29 ⁷ / ₈	17 ³ / ₄
	DRG3618	35 ⁷ / ₈	17 ³ / ₄
24	DRG1524	14 ⁷ / ₈	23 ³ / ₄
	DRG1824	18 ⁷ / ₈	23 ³ / ₄
30	DRG1530	14 ⁷ / ₈	29 ³ / ₄
	DRG15.530	15 ¹⁵ / ₁₆	29 ³ / ₄
	DRG1630	16 ³ / ₈	29 ³ / ₄
	DRG1830	17 ⁷ / ₈	29 ³ / ₄
36	DRG1536	14 ⁷ / ₈	35 ³ / ₄
	DRG15.536	15 ¹⁵ / ₁₆	35 ³ / ₄
	DRG1636	16 ³ / ₈	35 ³ / ₄
	DRG1836	17 ⁷ / ₈	35 ³ / ₄
42	DRG1542	14 ⁷ / ₈	41 ³ / ₄
	DRG15.542	15 ¹⁵ / ₁₆	41 ³ / ₄
	DRG1642	16 ³ / ₈	41 ³ / ₄
	DRG1842	17 ⁷ / ₈	41 ³ / ₄
48	DRG1548	14 ⁷ / ₈	47 ³ / ₄
	DRG1848	17 ⁷ / ₈	47 ³ / ₄
54	DRG1554	14 ⁷ / ₈	53 ³ / ₄
	DRG1854	17 ⁷ / ₈	53 ³ / ₄

EURO Replacement Items: Standard Drawers

Standard Replacement Drawer Kits

Base Drawer		Width	Height	Depth
RDK1221	12" Base Drawer	10 ^{1/3}	3 ^{15/16}	20 ^{7/8}
RDK1521	15" Base Drawer	13 ^{1/3}	3 ^{15/16}	20 ^{7/8}
RDK1821	18" Base Drawer	16 ^{1/3}	3 ^{15/16}	20 ^{7/8}
RDK2121	21" Base Drawer	19 ^{1/3}	3 ^{15/16}	20 ^{7/8}
RDK2421	24" Base Drawer	22 ^{1/3}	3 ^{15/16}	20 ^{7/8}
RDK2721	27" Base Drawer	25 ^{1/3}	3 ^{15/16}	20 ^{7/8}
RDK3021	30" Base Drawer	28 ^{1/3}	3 ^{15/16}	20 ^{7/8}
RDK3321	33" Base Drawer	31 ^{1/3}	3 ^{15/16}	20 ^{7/8}
RDK3621	36" Base Drawer	34 ^{1/3}	3 ^{15/16}	20 ^{7/8}

Base Drawer Deep		Width	Height	Depth
RDK1221D	12" Base Deep Drawer	10 ^{1/3}	7 ^{1/16}	20 ^{7/8}
RDK1521D	15" Base Deep Drawer	13 ^{1/3}	7 ^{1/16}	20 ^{7/8}
RDK1821D	18" Base Deep Drawer	16 ^{1/3}	7 ^{1/16}	20 ^{7/8}
RDK2121D	21" Base Deep Drawer	19 ^{1/3}	7 ^{1/16}	20 ^{7/8}
RDK2421D	24" Base Deep Drawer	22 ^{1/3}	7 ^{1/16}	20 ^{7/8}
RDK2721D	27" Base Deep Drawer	25 ^{1/3}	7 ^{1/16}	20 ^{7/8}
RDK3021D	30" Base Deep Drawer	28 ^{1/3}	7 ^{1/16}	20 ^{7/8}
RDK3321D	33" Base Deep Drawer	31 ^{1/3}	7 ^{1/16}	20 ^{7/8}
RDK3621D	36" Base Deep Drawer	34 ^{1/3}	7 ^{1/16}	20 ^{7/8}

Base Drawer Double Deep		Width	Height	Depth
RDK2421DD	24" Base Double Deep Drawer	22 ^{1/3}	10 ^{1/16}	20 ^{7/8}
RDK2721DD	27" Base Double Deep Drawer	25 ^{1/3}	10 ^{1/16}	20 ^{7/8}
RDK3021DD	30" Base Double Deep Drawer	28 ^{1/3}	10 ^{1/16}	20 ^{7/8}
RDK3321DD	33" Base Double Deep Drawer	31 ^{1/3}	10 ^{1/16}	20 ^{7/8}
RDK3621DD	36" Base Double Deep Drawer	34 ^{1/3}	10 ^{1/16}	20 ^{7/8}

Vanity Drawer		Width	Height	Depth
RDK1218	12" Vanity Drawer	10 ^{1/3}	3 ^{15/16}	17 ^{7/8}
RDK1518	15" Vanity Drawer	13 ^{1/3}	3 ^{15/16}	17 ^{7/8}
RDK1818	18" Vanity Drawer	16 ^{1/3}	3 ^{15/16}	17 ^{7/8}
RDK2118	21" Vanity Drawer	19 ^{1/3}	3 ^{15/16}	17 ^{7/8}
RDK2418	24" Vanity Drawer	22 ^{1/3}	3 ^{15/16}	17 ^{7/8}
RDK3018	30" Vanity Drawer	28 ^{1/3}	3 ^{15/16}	17 ^{7/8}
RDK3618	36" Vanity Drawer	34 ^{1/3}	3 ^{15/16}	17 ^{7/8}

Vanity Drawer Deep		Width	Height	Depth
RDK1218D	12" Vanity Deep Drawer	10 ^{1/3}	7 ^{1/16}	17 ^{7/8}
RDK1518D	15" Vanity Deep Drawer	13 ^{1/3}	7 ^{1/16}	17 ^{7/8}
RDK1818D	18" Vanity Deep Drawer	16 ^{1/3}	7 ^{1/16}	17 ^{7/8}
RDK2118D	21" Vanity Deep Drawer	19 ^{1/3}	7 ^{1/16}	17 ^{7/8}
RDK2418D	24" Vanity Deep Drawer	22 ^{1/3}	7 ^{1/16}	17 ^{7/8}
RDK2718D	27" Vanity Deep Drawer	25 ^{1/3}	7 ^{1/16}	17 ^{7/8}
RDK3018D	30" Vanity Deep Drawer	28 ^{1/3}	7 ^{1/16}	17 ^{7/8}
RDK3318D	33" Vanity Deep Drawer	31 ^{1/3}	7 ^{1/16}	17 ^{7/8}
RDK3618D	36" Vanity Deep Drawer	34 ^{1/3}	7 ^{1/16}	17 ^{7/8}

EURO Replacement Items: Standard Drawers

Standard Replacement Drawer Kits

Apron Drawer		Width	Height	Depth
RDK2418-AD	24" Apron Drawer / Desk File Drawer	22 ^{1/3}	3 ^{1/4}	17 ^{7/8}
RDK3018-AD	30" Apron Drawer / Desk File Drawer	28 ^{1/3}	3 ^{1/4}	17 ^{7/8}
RDK3618-AD	36" Apron Drawer / Desk File Drawer	34 ^{1/3}	3 ^{1/4}	17 ^{7/8}

Desk File Drawer "DF"		Width	Height	Depth
RDK1518-AD	15" DF Top Drawer	13 ^{1/3}	3 ^{1/4}	17 ^{7/8}
RDK1818-AD	18" DF Top Drawer	16 ^{1/3}	3 ^{1/4}	17 ^{7/8}

Desk File Deep Drawer "DF" & "DFF"		Width	Height	Depth
RDK1518DD	15" DF Deep Drawer	13 ^{1/3}	10 ^{1/6}	17 ^{7/8}
RDK1818DD	18" DF Deep Drawer	16 ^{1/3}	10 ^{1/6}	17 ^{7/8}
RDK3018DD	30" DF Deep Drawer	28 ^{1/3}	10 ^{1/6}	17 ^{7/8}
RDK3618DD	36" DF Deep Drawer	34 ^{1/3}	10 ^{1/6}	17 ^{7/8}

Wall Drawer		Width	Height	Depth
RDK1509	15" Wall Drawer	13 ^{1/3}	3 ^{15/16}	8 ^{7/8}
RDK1809	18" Wall Drawer	16 ^{1/3}	3 ^{15/16}	8 ^{7/8}

EuroTech Replacement Drawer Kits

Base Drawer		Width	Height	Depth
RDK1221M	12" Base Drawer	8 ^{9/16}	3 ^{3/8}	20 ^{7/8}
RDK1521M	15" Base Drawer	11 ^{9/16}	3 ^{3/8}	20 ^{7/8}
RDK1821M	18" Base Drawer	14 ^{9/16}	3 ^{3/8}	20 ^{7/8}
RDK2121M	21" Base Drawer	17 ^{9/16}	3 ^{3/8}	20 ^{7/8}
RDK2421M	24" Base Drawer	20 ^{9/16}	3 ^{3/8}	20 ^{7/8}
RDK2721M	27" Base Drawer	23 ^{9/16}	3 ^{3/8}	20 ^{7/8}
RDK3021M	30" Base Drawer	26 ^{9/16}	3 ^{3/8}	20 ^{7/8}
RDK3321M	33" Base Drawer	29 ^{9/16}	3 ^{3/8}	20 ^{7/8}
RDK3621M	36" Base Drawer	32 ^{9/16}	3 ^{3/8}	20 ^{7/8}

Base Drawer Deep		Width	Height	Depth
RDK1221DM	12" Base Deep Drawer	8 ^{9/16}	6 ^{1/4}	20 ^{7/8}
RDK1521DM	15" Base Deep Drawer	11 ^{9/16}	6 ^{1/4}	20 ^{7/8}
RDK1821DM	18" Base Deep Drawer	14 ^{9/16}	6 ^{1/4}	20 ^{7/8}
RDK2121DM	21" Base Deep Drawer	17 ^{9/16}	6 ^{1/4}	20 ^{7/8}
RDK2421DM	24" Base Deep Drawer	20 ^{9/16}	6 ^{1/4}	20 ^{7/8}
RDK2721DM	27" Base Deep Drawer	23 ^{9/16}	6 ^{1/4}	20 ^{7/8}
RDK3021DM	30" Base Deep Drawer	26 ^{9/16}	6 ^{1/4}	20 ^{7/8}
RDK3321DM	33" Base Deep Drawer	29 ^{9/16}	6 ^{1/4}	20 ^{7/8}
RDK3621DM	36" Base Deep Drawer	32 ^{9/16}	6 ^{1/4}	20 ^{7/8}

Base Drawer Double Deep		Width	Height	Depth
RDK2421DDM	24" Base Double Deep Drawer	20 ^{9/16}	10 ^{5/8}	20 ^{7/8}
RDK2721DDM	27" Base Double Deep Drawer	23 ^{9/16}	10 ^{5/8}	20 ^{7/8}
RDK3021DDM	30" Base Double Deep Drawer	26 ^{9/16}	10 ^{5/8}	20 ^{7/8}
RDK3321DDM	33" Base Double Deep Drawer	29 ^{9/16}	10 ^{5/8}	20 ^{7/8}
RDK3621DDM	36" Base Double Deep Drawer	32 ^{9/16}	10 ^{5/8}	20 ^{7/8}

EURO Replacement Items: EuroTech Drawers

EuroTech Replacement Drawer Kits (Continued)

Vanity Drawer		Width	Height	Depth
RDK1218M	12" Vanity Drawer	8 ^{9/16}	3 ^{3/8}	18 ^{7/8}
RDK1518M	15" Vanity Drawer	11 ^{9/16}	3 ^{3/8}	18 ^{7/8}
RDK1818M	18" Vanity Drawer	14 ^{9/16}	3 ^{3/8}	18 ^{7/8}
RDK2118M	21" Vanity Drawer	17 ^{9/16}	3 ^{3/8}	18 ^{7/8}
RDK2418M	24" Vanity Drawer	20 ^{9/16}	3 ^{3/8}	18 ^{7/8}
RDK2718M	27" Vanity Drawer	23 ^{9/16}	3 ^{3/8}	18 ^{7/8}
RDK3018M	30" Vanity Drawer	26 ^{9/16}	3 ^{3/8}	18 ^{7/8}
RDK3618M	36" Vanity Drawer	32 ^{9/16}	3 ^{3/8}	18 ^{7/8}

Vanity Drawer Deep		Width	Height	Depth
RDK1218DM	12" Vanity Deep Drawer	8 ^{9/16}	6 ^{1/4}	18 ^{7/8}
RDK1518DM	15" Vanity Deep Drawer	11 ^{9/16}	6 ^{1/4}	18 ^{7/8}
RDK1818DM	18" Vanity Deep Drawer	14 ^{9/16}	6 ^{1/4}	18 ^{7/8}
RDK2118DM	21" Vanity Deep Drawer	17 ^{9/16}	6 ^{1/4}	18 ^{7/8}
RDK2418DM	24" Vanity Deep Drawer	20 ^{9/16}	6 ^{1/4}	18 ^{7/8}
RDK2718DM	27" Vanity Deep Drawer	23 ^{9/16}	6 ^{1/4}	18 ^{7/8}
RDK3018DM	30" Vanity Deep Drawer	26 ^{9/16}	6 ^{1/4}	18 ^{7/8}
RDK3318DM	33" Vanity Deep Drawer	29 ^{9/16}	6 ^{1/4}	18 ^{7/8}
RDK3618DM	36" Vanity Deep Drawer	32 ^{9/16}	6 ^{1/4}	18 ^{7/8}

Vanity Drawer Double Deep		Width	Height	Depth
RDK1518DDM	15" Base Double Deep Drawer	11 ^{9/16}	10 ^{5/8}	20 ^{7/8}
RDK1818DDM	18" Base Double Deep Drawer	14 ^{9/16}	10 ^{5/8}	20 ^{7/8}
RDK3018DDM	30" Base Double Deep Drawer	26 ^{9/16}	10 ^{5/8}	20 ^{7/8}
RDK3618DDM	36" Base Double Deep Drawer	32 ^{9/16}	10 ^{5/8}	20 ^{7/8}

Wall Drawer		Width	Height	Depth
RDK1509M	15" Wall Drawer	11 ^{9/16}	3 ^{3/8}	9
RDK1809M	18" Wall Drawer	14 ^{9/16}	3 ^{3/8}	9

Desk File Deep Drawer "DF" & "DDF"		Width	Height	Depth
RDK1518DDM	15" Desk File Deep Drawer	11 ^{9/16}	10 ^{5/8}	18 ^{7/8}
RDK1818DDM	18" Desk File Deep Drawer	14 ^{9/16}	10 ^{5/8}	18 ^{7/8}
RDK3018DDM	30" Desk File Deep Drawer	26 ^{9/16}	10 ^{5/8}	18 ^{7/8}
RDK3618DDM	36" Desk File Deep Drawer	32 ^{9/16}	10 ^{5/8}	18 ^{7/8}

EURO Replacement Items: Pullouts & Shelving

Pullouts & Shelving

Upper Pullouts - 21" Deep		Width	Height	Depth
RPK1221	12" Pullout	9 ^{3/8}	3 ^{5/16}	20 ^{13/16}
RPK1521	15" Pullout	12 ^{3/8}	3 ^{5/16}	20 ^{13/16}
RPK1821	18" Pullout	15 ^{3/8}	3 ^{5/16}	20 ^{13/16}
RPK2121	21" Pullout	18 ^{3/8}	3 ^{5/16}	20 ^{13/16}
RPK2421	24" Pullout	21 ^{3/8}	3 ^{5/16}	20 ^{13/16}
RPK2721	27" Pullout	24 ^{3/8}	3 ^{5/16}	20 ^{13/16}
RPK3021	30" Pullout	27 ^{3/8}	3 ^{5/16}	20 ^{13/16}
RPK3321	33" Pullout	30 ^{3/8}	3 ^{5/16}	20 ^{13/16}
RPK3621	36" Pullout	33 ^{3/8}	3 ^{5/16}	20 ^{13/16}

Upper Pullouts - 18" Deep		Width	Height	Depth
RPK1218	12" Pullout	9 ^{3/8}	3 ^{5/16}	17 ^{13/16}
RPK1518	15" Pullout	12 ^{3/8}	3 ^{5/16}	17 ^{13/16}
RPK1818	18" Pullout	15 ^{3/8}	3 ^{5/16}	17 ^{13/16}
RPK2118	21" Pullout	18 ^{3/8}	3 ^{5/16}	17 ^{13/16}
RPK2418	24" Pullout	21 ^{3/8}	3 ^{5/16}	17 ^{13/16}
RPK2718	27" Pullout	24 ^{3/8}	3 ^{5/16}	17 ^{13/16}
RPK3018	30" Pullout	27 ^{3/8}	3 ^{5/16}	17 ^{13/16}
RPK3318	33" Pullout	30 ^{3/8}	3 ^{5/16}	17 ^{13/16}
RPK3618	36" Pullout	33 ^{3/8}	3 ^{5/16}	17 ^{13/16}

Bottom Pullouts - 21" Deep		Width	Height	Depth
RPK1221B	12" Pullout	9 ^{3/8}	2	20 ^{13/16}
RPK1521B	15" Pullout	12 ^{3/8}	2	20 ^{13/16}
RPK1821B	18" Pullout	15 ^{3/8}	2	20 ^{13/16}
RPK2121B	21" Pullout	18 ^{3/8}	2	20 ^{13/16}
RPK2421B	24" Pullout	21 ^{3/8}	2	20 ^{13/16}
RPK2721B	27" Pullout	24 ^{3/8}	2	20 ^{13/16}
RPK3021B	30" Pullout	27 ^{3/8}	2	20 ^{13/16}
RPK3321B	33" Pullout	30 ^{3/8}	2	20 ^{13/16}
RPK3621B	36" Pullout	33 ^{3/8}	2	20 ^{13/16}

Bottom Pullouts - 18" Deep		Width	Height	Depth
RPK1218B	12" Pullout	9 ^{3/8}	2	17 ^{13/16}
RPK1518B	15" Pullout	12 ^{3/8}	2	17 ^{13/16}
RPK1818B	18" Pullout	15 ^{3/8}	2	17 ^{13/16}
RPK2118B	21" Pullout	18 ^{3/8}	2	17 ^{13/16}
RPK2418B	24" Pullout	21 ^{3/8}	2	17 ^{13/16}
RPK2718B	27" Pullout	24 ^{3/8}	2	17 ^{13/16}
RPK3018B	30" Pullout	27 ^{3/8}	2	17 ^{13/16}
RPK3318B	33" Pullout	30 ^{3/8}	2	17 ^{13/16}
RPK3618B	36" Pullout	33 ^{3/8}	2	17 ^{13/16}

Spice Pullouts		Width	Height	Depth
SPICE-RACK06	6" Spice-Rack	3 ^{1/5}	22 ^{1/8}	23 ^{1/2}
SPICE-RACK09	9" Spice-Rack	6 ^{7/16}	22 ^{1/8}	23 ^{1/2}
SPICE-RACK12	12" Spice-Rack	8 ^{3/16}	22 ^{1/8}	23 ^{1/2}
SPICE-RACK15	15" Spice-Rack	12 ^{7/16}	22 ^{1/8}	23 ^{1/2}
SPICE-RACK18	18" Spice-Rack	15 ^{7/16}	22 ^{1/8}	23 ^{1/2}

Trash Can Pullouts		Width	Height	Depth
POTC1522*	15" Trash Pullout	12 ^{15/16}	15	21
POTC1822*	18" Trash Pullout	15 ^{15/16}	8 ^{1/2}	21
POTC2122*	21" Trash Pullout	18 ^{15/16}	8 ^{1/2}	21
TRASH-CAN35	35qt Trash Can	10 ^{1/2}	17 ^{3/4}	14
TRASH-CAN50	50qt Trash Can	10 ^{1/2}	21 ^{3/4}	14

*Note: Trash Cans Sold Separately

Shelves 12" Deep		Width	Depth
SH09	9" Shelf	7 ^{9/16}	11 ^{1/16}
SH12	12" Shelf	10 ^{9/16}	11 ^{1/16}
SH15	15" Shelf	13 ^{9/16}	11 ^{1/16}
SH18	18" Shelf	16 ^{9/16}	11 ^{1/16}
SH21	21" Shelf	19 ^{9/16}	11 ^{1/16}
SH24	24" Shelf	22 ^{9/16}	11 ^{1/16}
SH27	27" Shelf	25 ^{9/16}	11 ^{1/16}
SH30	30" Shelf	28 ^{9/16}	11 ^{1/16}
SH33	33" Shelf	31 ^{9/16}	11 ^{1/16}
SH36	36" Shelf	34 ^{9/16}	11 ^{1/16}

Pantry Shelf Kits (12" Deep Utility)		Width	Depth
PSK15	15" Pantry Shelf Kit-4pk	13 ^{9/16}	11 ^{1/16}
PSK18	18" Pantry Shelf Kit-4pk	16 ^{9/16}	11 ^{1/16}
PSK24	24" Pantry Shelf Kit-4pk	22 ^{9/16}	11 ^{1/16}
PSK30	30" Pantry Shelf Kit-4pk	28 ^{9/16}	11 ^{1/16}

Shelves 15" Deep		Width	Depth
SH3615	36" Shelf	34 ^{9/16}	14 ^{1/16}

Full Depth Shelf Kits (24" Deep Utility)		Width	Depth
FDSK15	15" Full Depth Shelf Kit-4pk	13 ^{9/16}	23 ^{1/8}
FDSK18	18" Full Depth Shelf Kit-4pk	16 ^{9/16}	23 ^{1/8}
FDSK24	24" Full Depth Shelf Kit-4pk	22 ^{9/16}	23 ^{1/8}
FDSK30	30" Full Depth Shelf Kit-4pk	28 ^{9/16}	23 ^{1/8}

Shelves 21" Deep		Width	Depth
SH1821	18" Shelf	16 ^{9/16}	20 ^{1/8}

Pullout Tray Kits-Tall Cabinets		Width	Depth	Height
POT15	15" Pullout Tray Kit	12 ^{3/8}	3 ^{5/16}	20 ^{13/16}
POT18	18" Pullout Tray Kit	15 ^{3/8}	3 ^{5/16}	20 ^{13/16}
POT24	24" Pullout Tray Kit	21 ^{3/8}	3 ^{5/16}	20 ^{13/16}
POT30	30" Pullout Tray Kit	27 ^{3/8}	3 ^{5/16}	20 ^{13/16}

Shelves 24" Deep		Width	Depth
SH1524	15" Shelf	13 ^{9/16}	23 ^{1/8}
SH1824	18" Shelf	16 ^{9/16}	23 ^{1/8}
SH2424	24" Shelf	22 ^{9/16}	23 ^{1/8}
SH3024	30" Shelf	28 ^{9/16}	23 ^{1/8}
SH3324	33" Shelf	31 ^{9/16}	23 ^{1/8}

Wall Corner Shelves		Width	Depth
WCSH24	24" Wall Corner Shelf	22 ^{5/8}	22 ^{5/8}
WPCSH24	24" Wall Pie Cut Shelf	22 ^{5/8}	22 ^{5/8}

EURO Replacement Items: Trim Kits

Trim Kits

	Width	Height	Depth
Base Microwave Trim Kit			
OTKF2721	26 ⁷ / ₈	23 ³ / ₄	3/4
OTKF3021	29 ⁷ / ₈	23 ³ / ₄	3/4

Oven Trim Kit Full

OTKF3030	29 ⁷ / ₈	32 ³ / ₁₆	3/4
OTKF3330	32 ⁷ / ₈	32 ³ / ₁₆	3/4
OTKF3054	29 ⁷ / ₈	55 ¹⁵ / ₁₆	3/4
OTKF3354	32 ⁷ / ₈	55 ¹⁵ / ₁₆	3/4

Note: When cutting OTKF, you must leave at least 35mm "Frame" on all sides

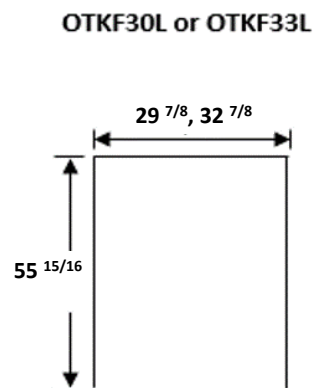
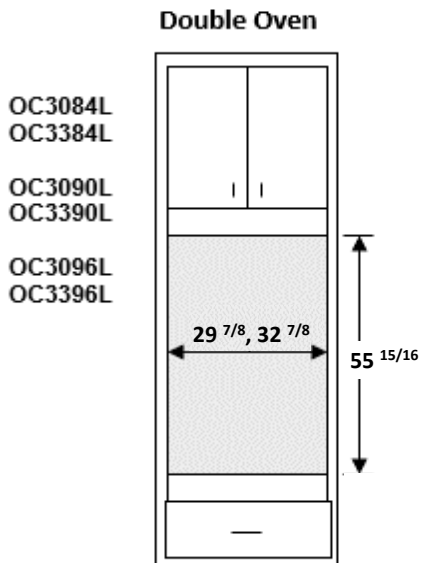
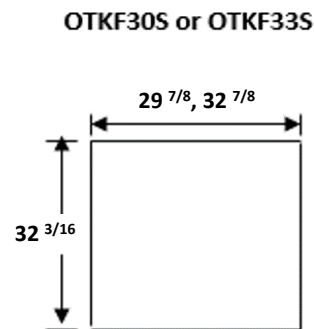
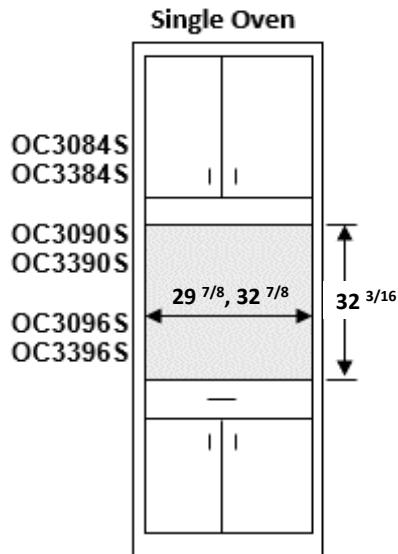

TAB: Appliance Panels

Appliance Panels

- *Index*
- *Pricing*
- *Panel Specifications*

Appliance Panels

Free-standing 36"W x 72"H	2 PANEL
	3 PANEL
Built-ins 36"W x 84"H	2 PANEL
	3 PANEL
	Add for a Grille Panel
Built-ins 42"W x 84"H	2 PANEL
	3 PANEL
	Add for a Grille Panel
Built-ins 48"W x 84"H	2 PANEL
	3 PANEL
	Add for a Grille Panel
Dishwasher Panels	
Warming Drawer Panels	
Trash Compactor Panels	
Wine Refrigerator Panels	
Under Counter Refrigerator Panels	

****Please note that Grille Panels are raised**

****Not available in Value or Gatehouse Series**

Item Codes
PANEL-APPL1
PANEL-APPL2
PANEL-APPL3
PANEL-APPL4
PANEL-APPL5
PANEL-APPL6
PANEL-APPL7
PANEL-APPL8
PANEL-APPL9

Dishwasher "Framed" (1/4")

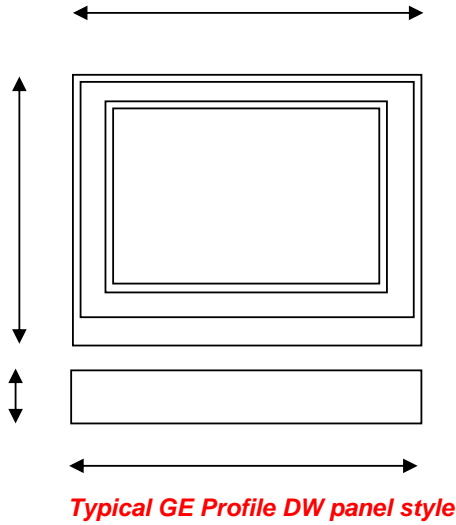

Typical "Framed" Dishwasher panel. This is a 3/4" thick door with 1/4" thick trim around all sides. There is a 2 1/2" reveal at the bottom and 1/2" on all other sides.

The bottom access panel is always 1/4" flat material.

NOTE: This panel is sometimes a different width than the top panel.

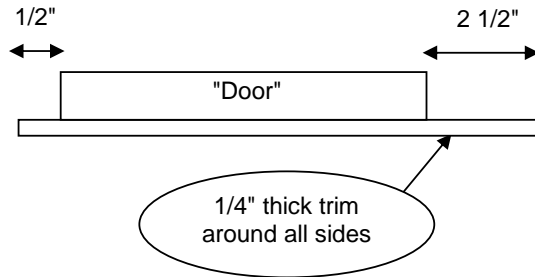

Dishwasher
"Overlay NO Routing" (3/4")

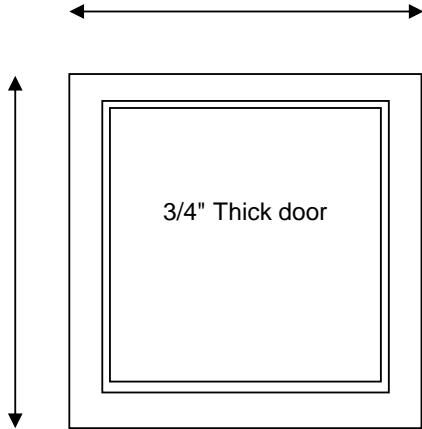

Typical "Overlay" Dishwasher panel. This is a 3/4" thick door

Typical GE Monogram DW panel style

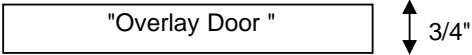

Appliance Panels: Panel Specifications

Dishwasher - Double Drawer "Overlay NO Routing" (3/4")

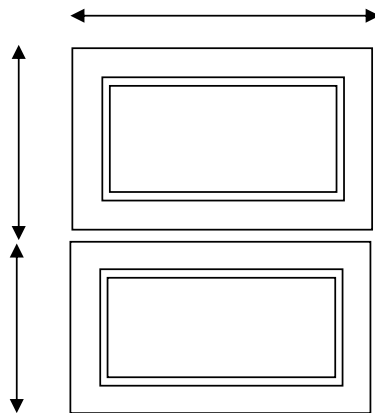

Typical Double Drawer appliance. Available for Single or Double drawer DW's, Refrigerators/Freezers etc. These are always Overlay Doors however the routing detail (if any) will depend on the specs

Typical Double Drawer DW, Ref or Freezer etc.

Most Manufacturers supply the exact panel sizes needed

3/4" Overlay Panel Dimensions (in inches)	
	A (Width) B (Height)
1/4" Backer	23-3/16" 14-11/16"
0.10" Spacer	22-1/2" 14-8/16"
3/4" Overlay	23-5/8" 15-1/16"

*Maintain a 1/4" min. gap between top and bottom drawer panels.

Assemble overlay panels with glue and screws.

- Center spacer panel on the backer panel, left to right and top to bottom. Secure the panels with glue.
- Center the spacer/backer panel on the overlay panel. Secure with glue and screws. Countersink all screws into the backer panel.

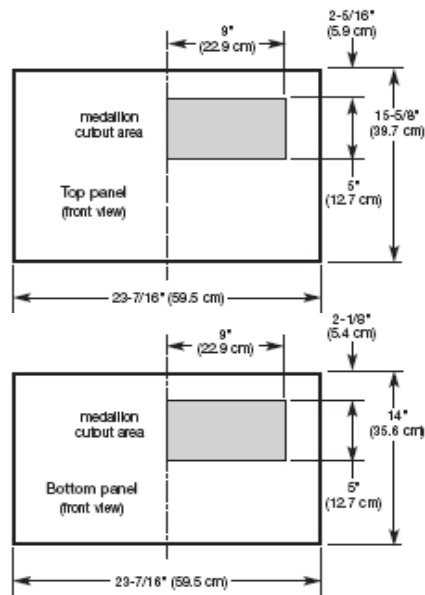
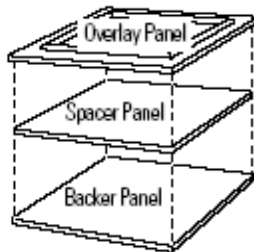

GE Monogram Double Drawer Refrigerator

This would be an example of "Overlay Special Routing"

Kitchen Aid typical Double Drawer Dishwasher

This would be an example of "Overlay No Routing"

Take note of dimensional difference between overlay size and backer size:
3/8" difference for **HEIGHT**
7/16" difference for **WIDTH**

Always be sure to inform your customers that we can not cut out for "medallion" area on any panel

Appliance Panels: Panel Specifications

Dishwasher - Double Drawer "Overlay NO Routing" (3/4")

Typical Fisher & Paykel Double Drawer Dishwasher

The Door and Toe Kick Panels of the DishDrawer® can be made to match your kitchen cabinetry. This diagram, with the addition of your own measurements will help you calculate the required panel sizes.

CABINERY ALIGNMENT

The following calculations assume:

The top of the Upper Panel is to be aligned with the top of the adjacent cabinetry. The final panel/cabinetry alignment is achieved by adjusting the DishDrawer's feet

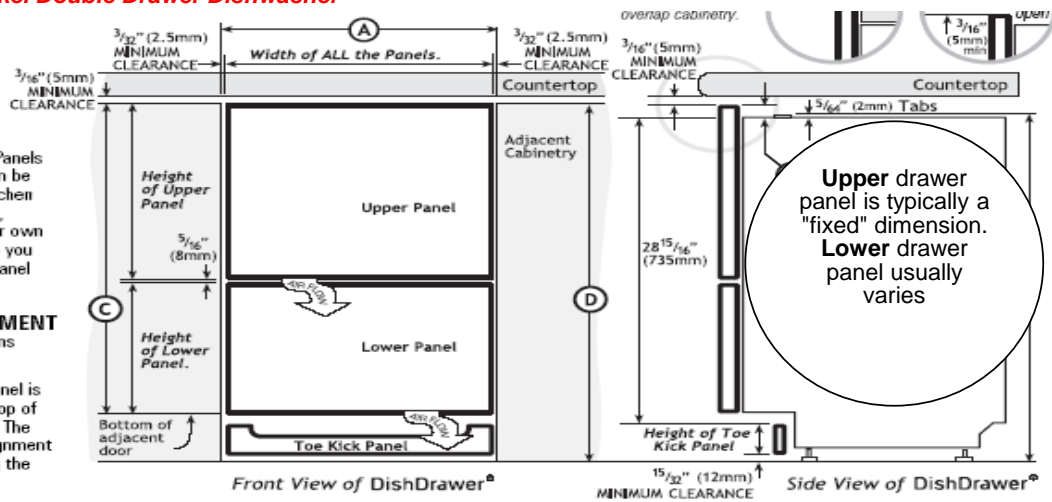

WIDTH OF ALL PANELS

Measure (A) the width between adjacent door/drawer fronts and write it in the first box below, then complete the equation. For example:

$$\textcircled{A} 24\frac{1}{4} (616\text{mm}) - 2 \times \frac{3}{32} (2.5\text{mm}) = 24\frac{1}{16} (611\text{mm})$$

door clearance width of all panels

$$\textcircled{A} 24 - 2 \times \frac{1}{8} = 23\frac{3}{4}$$

door clearance width of all panels
(3/32" (2.5mm) MIN) (23 7/16" (595mm) MIN)

HEIGHT OF UPPER PANEL

For example: $15\frac{5}{8} (398\text{mm}) + \textcircled{B} 0\text{mm} = 15\frac{5}{8} (398\text{mm})$

standard height door extension height of upper panel

$$\textcircled{A} 15\frac{5}{8} (398\text{mm}) + \textcircled{B} 0 = 15\frac{5}{8}$$

standard height door extension (0" recommended) height of upper panel

HEIGHT OF LOWER PANEL

Measure (C) door/drawer height (or equivalent) and write it in the first box below, then complete the equation. For example:

$$\textcircled{C} 30" (762\text{mm}) - 15\frac{5}{8}" (398\text{mm}) - \frac{5}{16}" (8\text{mm}) = 14\frac{1}{16}" (356\text{mm})$$

height of upper panel air gap height of lower panel

$$\textcircled{C} 29\frac{13}{32} - 15\frac{5}{8} - \frac{5}{16} = 13\frac{15}{32}$$

MIN 28 1/4" (717.5mm) + (B) height of upper panel gap between panels height of lower panel
(12 17/64" (311.5mm) MIN)

CARRIAGE HOUSE

Use same calculation for top drawer in CHS doors. However use different formula for the lower drawer.

Dishwasher - Double Drawer "Overlay NO Routing" (3/4")

Typical Fisher & Paykel Single Drawer Dishwasher

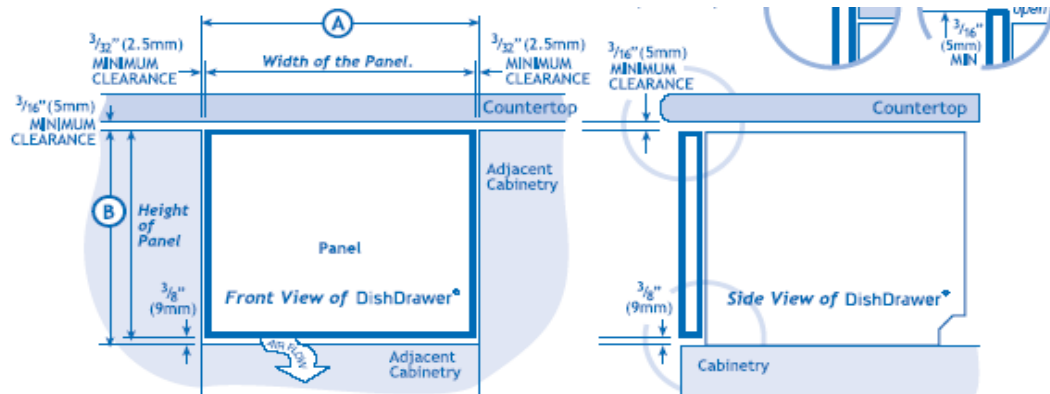

⚠ WARNING
Be sure the Product is not plugged in.

The Door of the DishDrawer* can be made to match your kitchen cabinetry. This diagram, with the addition of your own measurements will help you calculate the required panel sizes.

Installer must leave 3/8" (9mm) gap for correct ventilation.

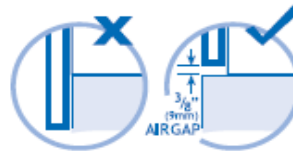

WIDTH OF THE PANEL

Measure **A** the width between adjacent door/drawer fronts and write it in the first box below, then complete the equation.

For example: A $24\frac{1}{4}$ (616mm) $- 2 \times \frac{3}{32}$ (2.5mm) = $24\frac{1}{16}$ (611mm) panel width

$$A \quad 24 \quad - \quad 2x \quad \frac{1}{8} \quad = \quad 23 \frac{3}{4}$$

door clearance (3/32" (2.5mm) MIN)
panel width (23 7/16" (595mm) MIN)

HEIGHT OF THE PANEL

Measure **B** door/drawer height (or equivalent) and write it in the first box below, then complete the equation.

For example: B 16 (407mm) $- \frac{3}{8}$ (9mm) = $15\frac{5}{8}$ (398mm) panel height

$$B \quad 16 \quad - \quad \frac{3}{8} \quad = \quad 15 \frac{5}{8}$$

air gap (9mm)
gap between panels (15 5/8" (398mm) MIN)

Note: When the top of the DishDrawer* has to be lower than the adjacent cabinetry, the Panel can be increased in height.

⚠ WARNING!

The air vent between the Panel and the adjacent cabinetry must not be covered. An air gap of 3/8" (9mm) MUST be provided.

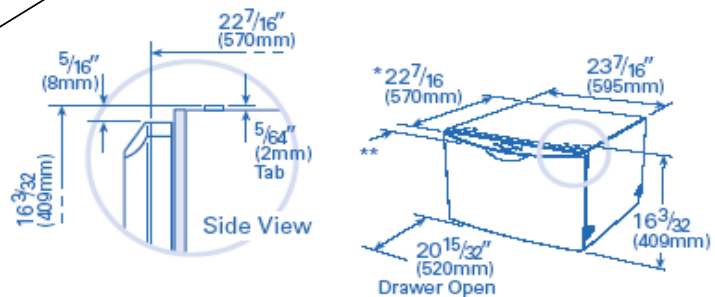

Use same calculation for the panel width as the double drawer panel.
Suggest to use the same height drawer as the standard height of the double drawer above. This can be used for **CHS** product.

Refrigerator - Side by Side "Framed" (1/4")

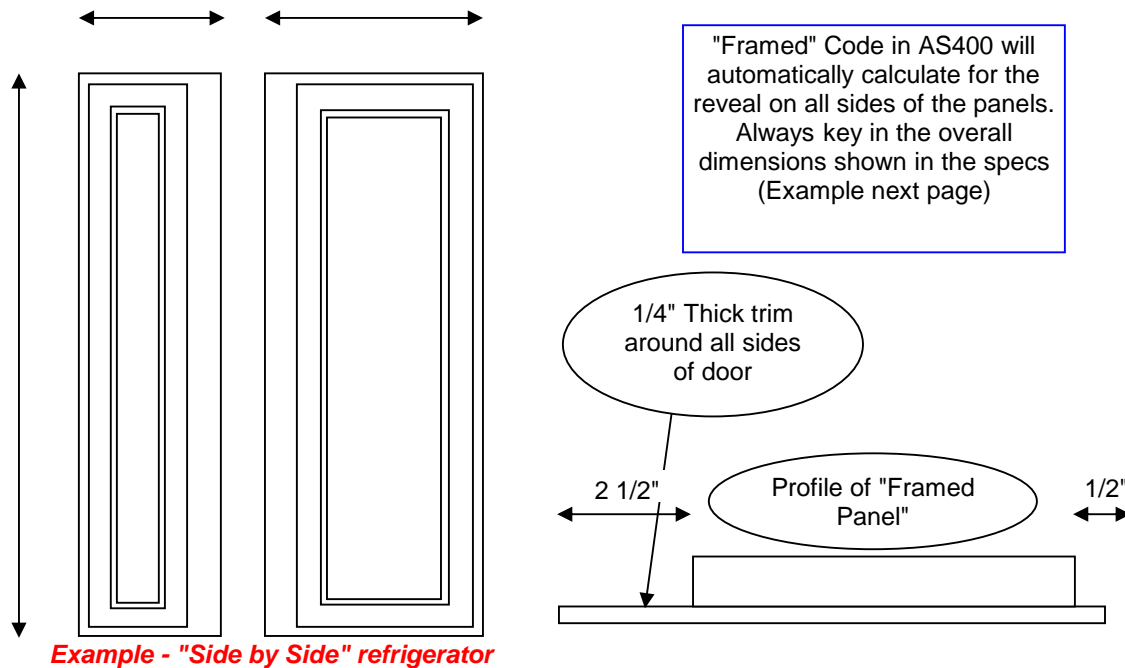
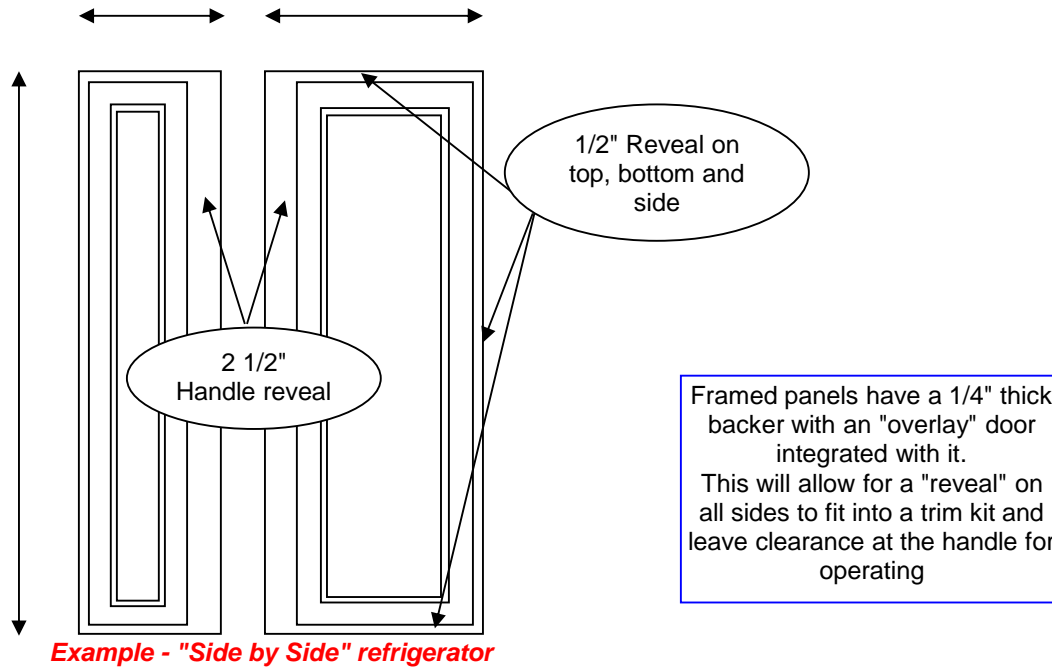

Refrigerator - Side by Side "Framed" (1/4")

Example of typical GE Profile Side by Side spec

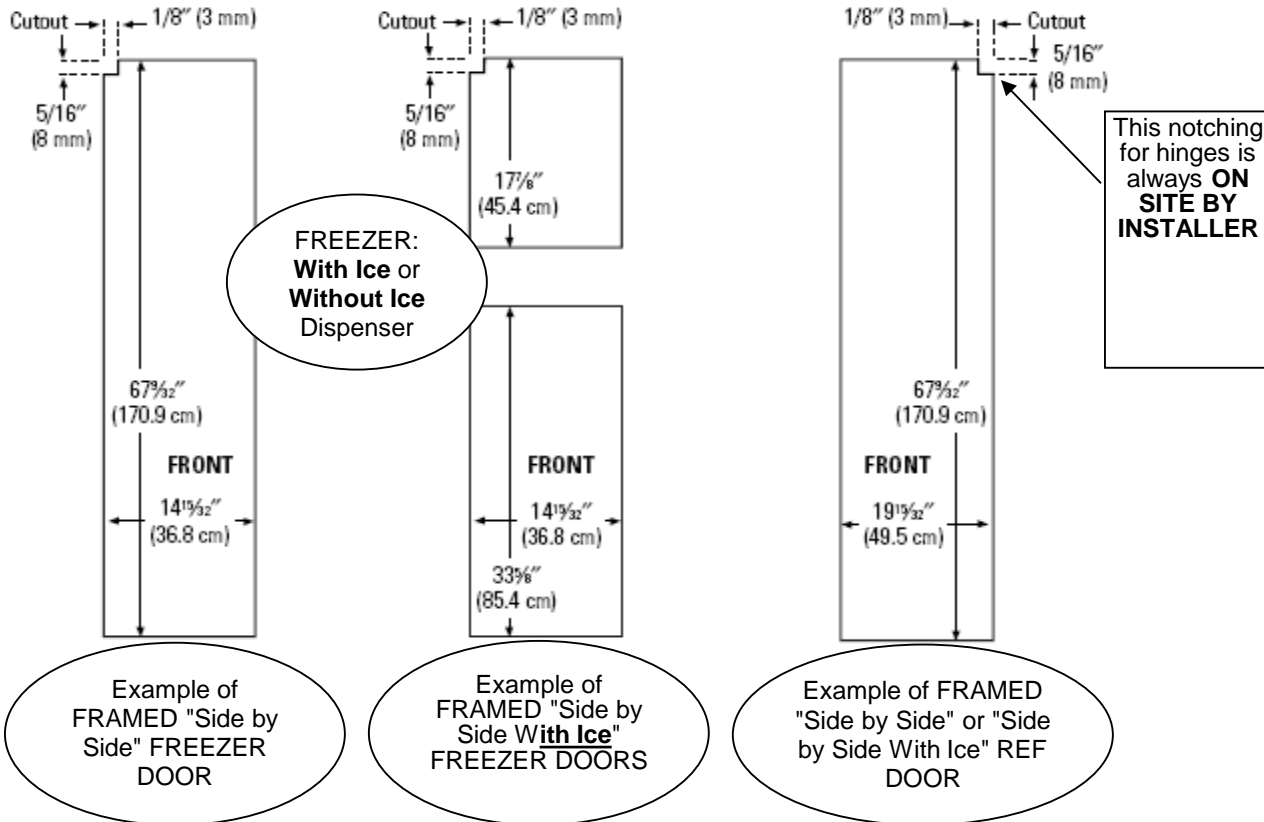

NOTE:

Always be sure to clarify with your customer if they are getting a dispenser or not.

Panels 1/4" thick or less

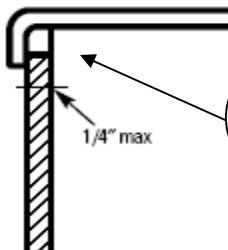

This is the typical information you will find in the spec pages. It is saying that the maximum thickness is 1/4". This is what a FRAMED appliance panel will have on all sides to fit into the trim kit.

Refrigerator - Refrigerator over Freezer "Overlay NO Routing" (3/4")

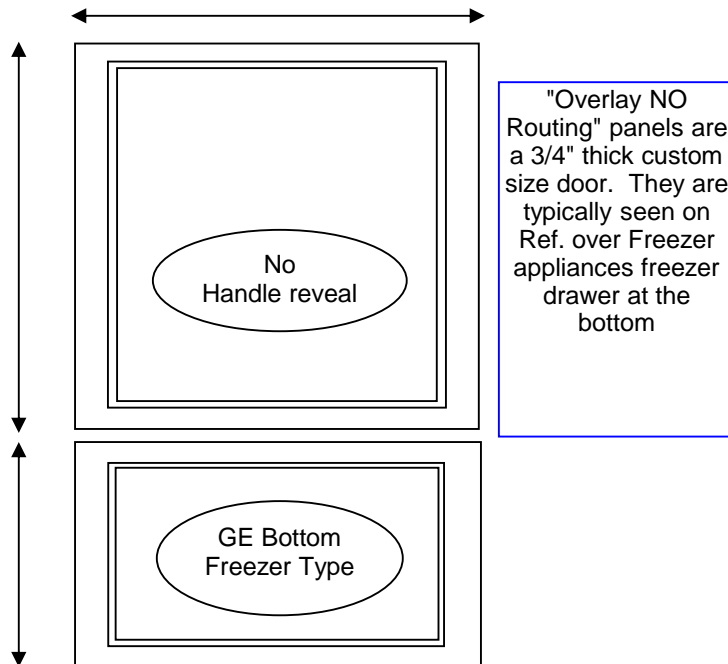

Example - "Refrigerator over Freezer"

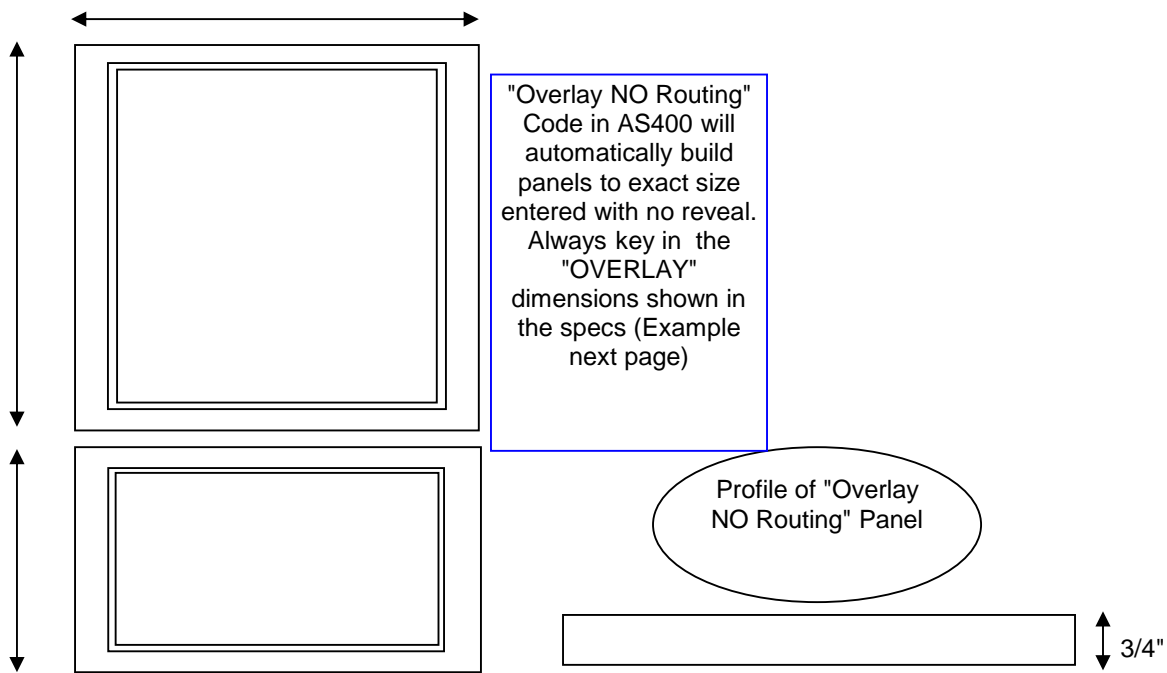

Example - "Refrigerator over Freezer"

Refrigerator - Refrigerator over Freezer "Overlay NO Routing" (3/4")

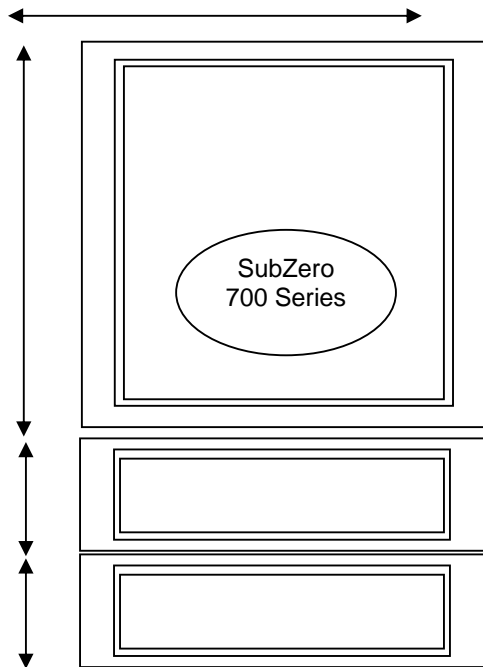

"Overlay NO Routing" panels are a 3/4" thick custom size door. They are typically seen on Ref. over Freezer appliances like the SubZero 700 series with the freezer drawers at the bottom

Example - "Refrigerator over Freezer drawers"

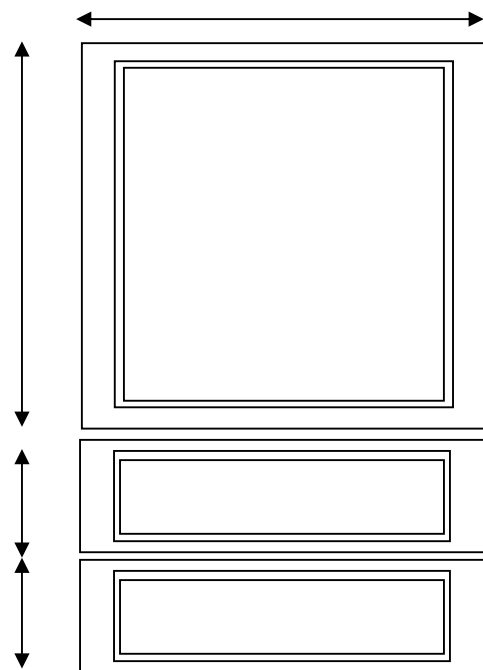

"Overlay NO Routing" Code in AS400 will automatically build panels to exact size entered with no reveal. Always key in the "OVERLAY" dimensions shown in the specs (Example next page)

Profile of "Overlay NO Routing" Panel

Example - "Refrigerator over Freezer drawers"

Refrigerator - Refrigerator over Freezer "Overlay NO Routing" (3/4")

Example of typical GE Refrigerator

Custom Door Panel Dimensions
Using Trim Kits ZKTC36L or ZKTC36R
3/4" thick panel with kit supplied handle

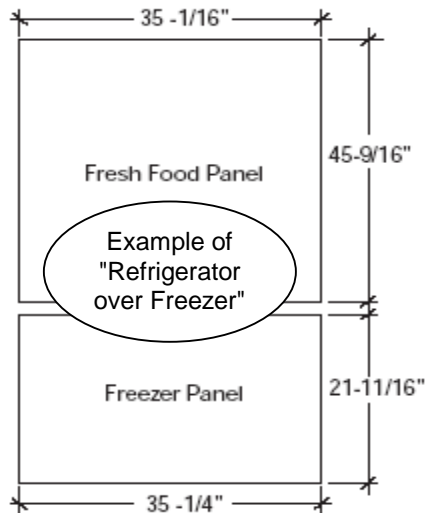

ZIS36N Bottom Mount Refrigerator

- The ZKTC36L (or ZKTC36R) trim kit provides for the installation of 3/4" thick custom door and grille panels, using the supplied handle. Cut panels to size and install.

Always be careful to clarify which handles are being supplied because it could affect the panel sizes

Refrigerator - Refrigerator over Freezer "Overlay NO Routing" (3/4")

Example of typical SubZero 700 Series Refrigerator (shown available in 27" or 36" width appliance)

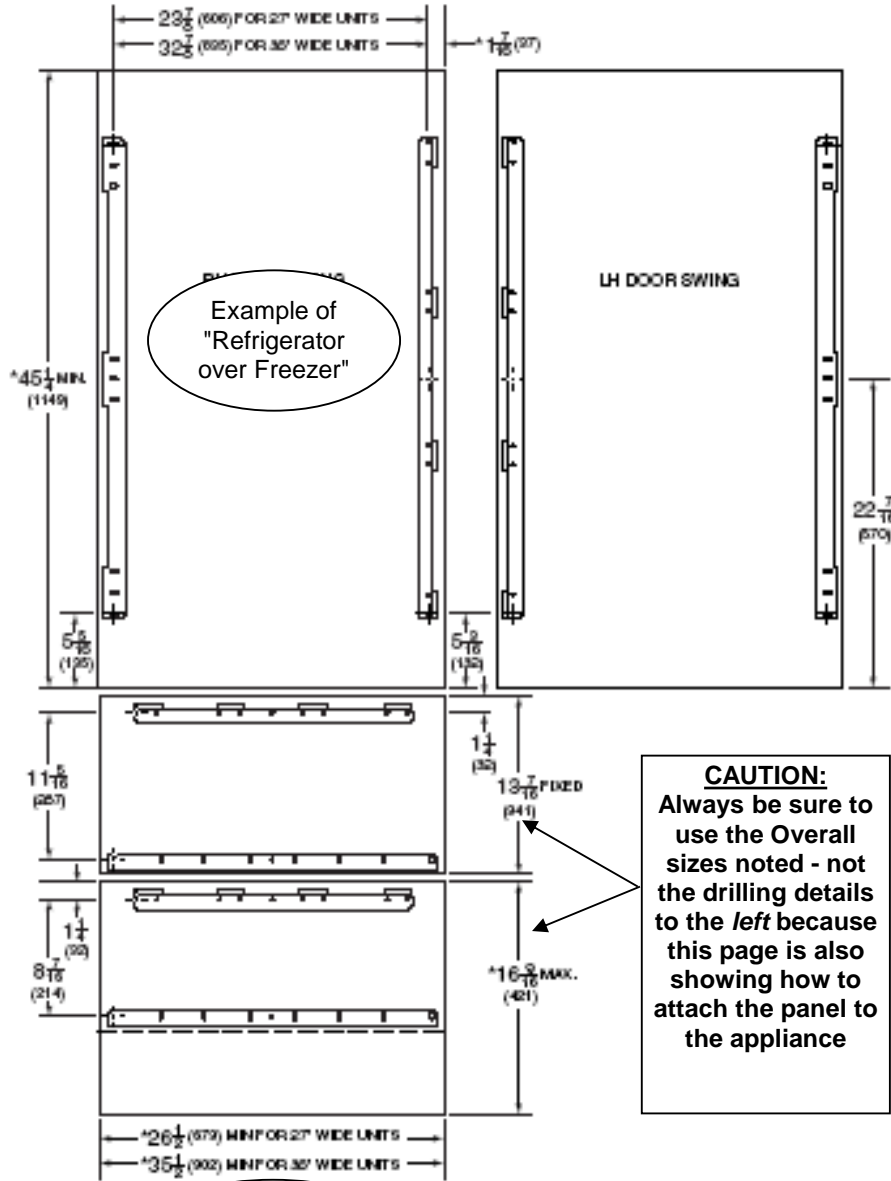

CAUTION:
Always be sure to use the Overall sizes noted - not the drilling details to the left because this page is also showing how to attach the panel to the appliance

For drawer only undercounter units use the dimensions shown for just the 2 drawers

Refrigerator - Side by Side "Overlay WITH Routing" (3/4")

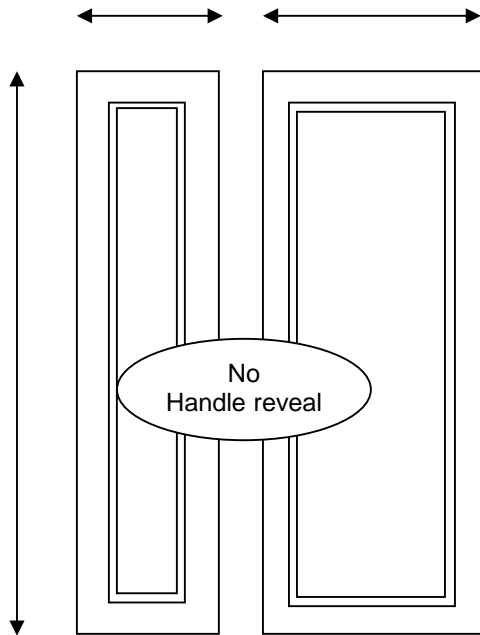

Example - "Side by Side" refrigerator

"Overlay With Routing" panels are a 3/4" thick custom size door with a routing detail around all sides of the door to act as the "spacer" and "backer" panels

Example of typical Overlay WITH Routing Refrigerator

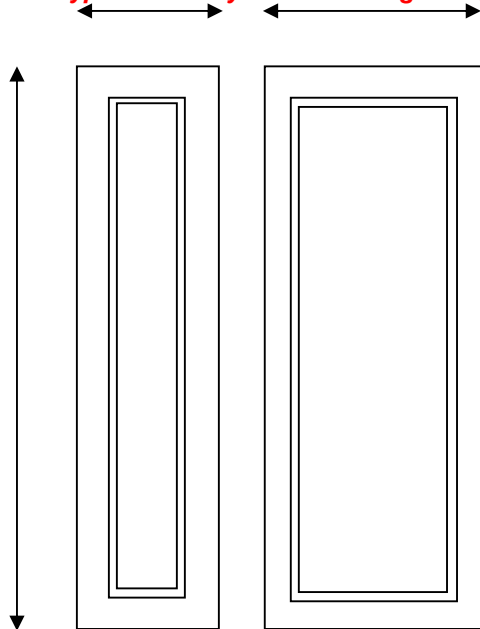

Example - "Side by Side" refrigerator

"Overlay WITH Routing" Code in AS400 will build the panels to exact size entered with no reveal. Always key in the "OVERLAY" dimensions shown in the specs (Example next page). HOWEVER details regarding the routing dimensions may need to be submitted to ensure proper fit.

Profile of "Overlay WITH Routing" Panel

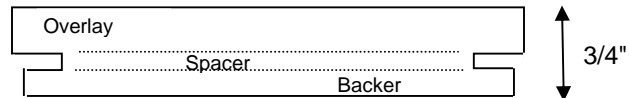

See Illustration 12 & 13 next page

Refrigerator - Side by Side "Overlay WITH Routing" (3/4")

Example of typical Overlay WITH Routing Refrigerator

Model 642

Refrigerator Overlay Panel	24 ⁵ / ₁₆ " (618)	68" (1727)
Refrigerator Spacer Panel	23 ³ / ₈ " (594)	67 ¹ / ₁₆ " (1703)
Refrigerator Backer Panel	24" (610)	67 ¹¹ / ₁₆ " (1719)
Freezer Overlay Panel	15 ¹⁵ / ₁₆ " (405)	68" (1727)
Freezer Spacer Panel	15" (381)	67 ¹ / ₁₆ " (1703)
Freezer Backer Panel	15 ⁵ / ₈ " (397)	67 ¹¹ / ₁₆ " (1719)

Models 642 and 685	W
Overlay Panel Width	40 ⁷ / ₁₆ " (1027)
Spacer Panel Width	39 ¹ / ₂ " (1003)
Backer Panel Width	40 ¹ / ₈ " (1019)
11" (279) Grille (standard)	H
Overlay Panel Height	10 ¹ / ₄ " (260)
Spacer Panel Height	9 ⁵ / ₁₆ " (237)
Backer Panel Height	9 ¹⁵ / ₁₆ " (252)

Key In Overlay dimensions on your order

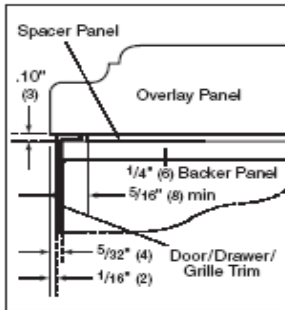

Illus. 12

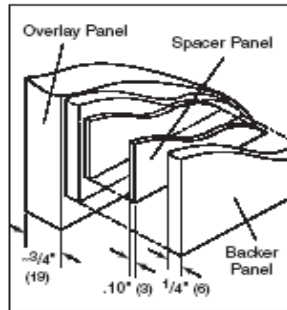

Illus. 13

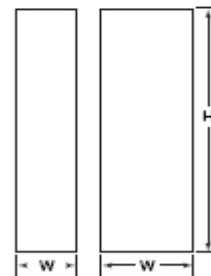

Models 661, 642 and 632

Panel specifications are for Built-in overlay (O) models.

For grille panel size, use width dimensions listed for your model and height dimensions for grille option. **11" (279) grille is standard.**

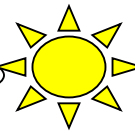

Panel grille is available for all overlay units except Models 601R, 601RG and 601F.

See note on next page to

Whenever you see 3/4" Thick panels indicated in your panel specs, that is the clue that you need to either use Overlay WITH or NO Routing. Most SubZero's work with our "WITH Routing" code but some MFG's require special details. See "[Special Routing Details](#)" pages for more info.

Refrigerator - French Doors "Overlay WITH Routing" for *French Doors Style (3/4")*

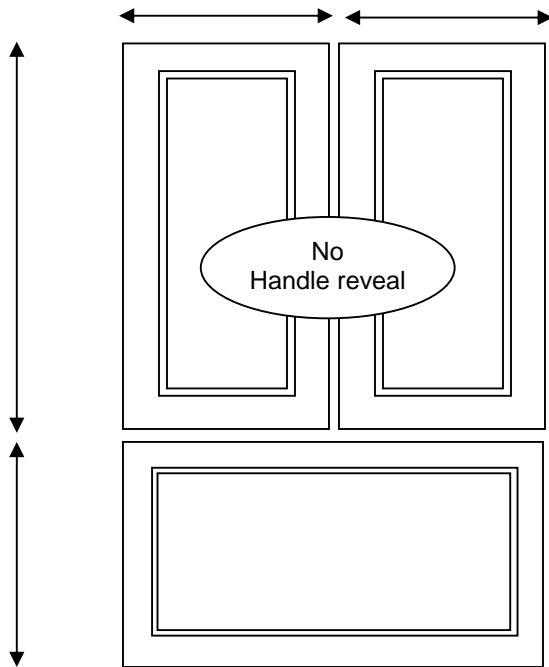

Example - "French Door style Refrigerator"

"Overlay WITH Routing" for French Door style Refrigerators are a 3/4" thick custom size door with **special routing placement**. The *Refrigerator* gets routed on the Top, Bottom and NON-hinge sides. The *Freezer* gets routed on all 4 sides

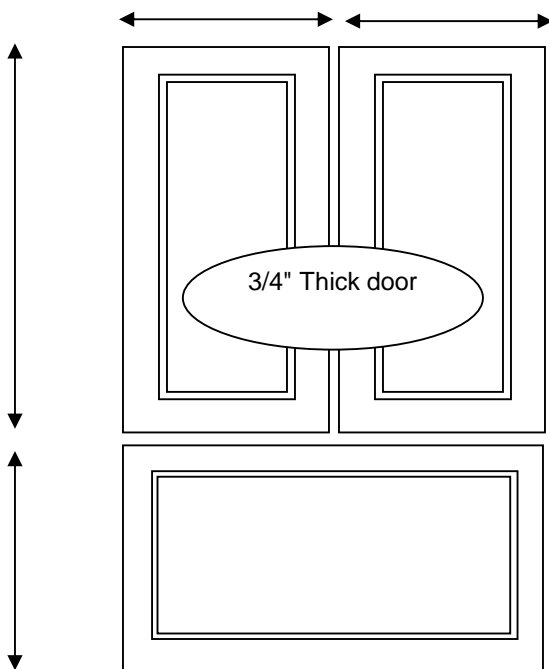

"Overlay NO Routing" Code in AS400 will automatically build panels to exact size entered with no reveal. Always key in the "OVERLAY" dimensions shown in the specs (Example next page)

Profile of "Overlay WITH Routing" Panel for French Door Ref.

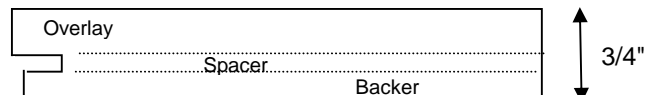

Refrigerator - French Doors "Overlay WITH Routing" for *French Doors Style (3/4")*

NOTE: Although routing detail will show thru on the Handle side, the bottom of the trim kit covers the routed detail that would be seen from the handle side

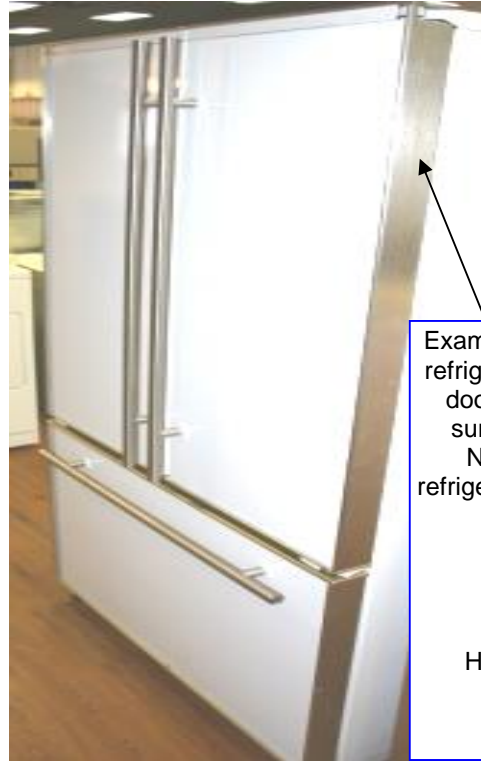

Example of Viking French Door refrigerator to accept appliance door panels. Metal Trim kit surrounds top, bottom and NON-handle side of the refrigerator doors and all 4 sides of the Freezer door.

Photo courtesy of
Ron Barkman Sr.
at
Home Appliance Center
Malvern, PA

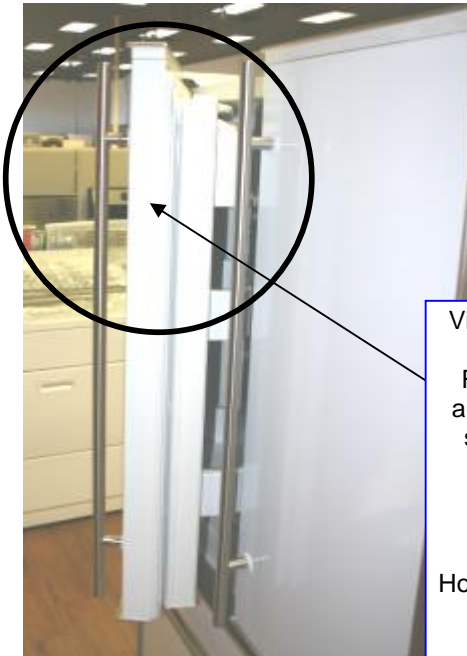

View of handle side of refrigerator door. Routing detail is not applied on the handle sides of the panels.

Photo courtesy of
Ron Barkman Sr.
at
Home Appliance Center
Malvern, PA

Refrigerator - Side by Side *with Dispenser Cutout* "Overlay WITH Special Backer (3/4" + 3/8")

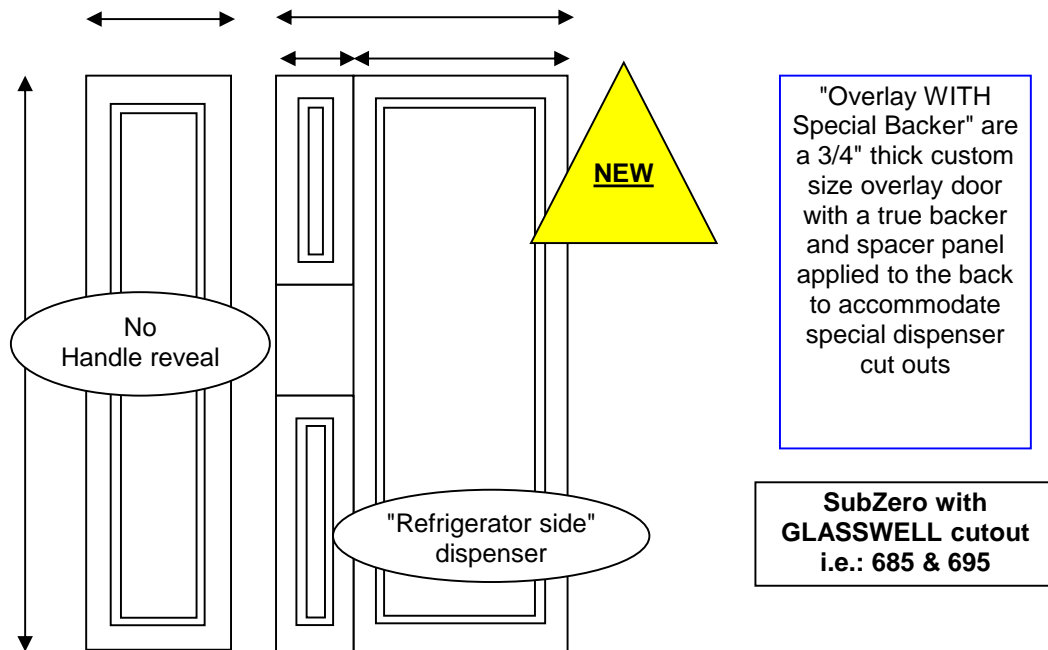

Example - "Side by Side" with dispenser cut out on Refrigerator Door

Example of typical Overlay WITH Special Backer for Refrigerator with Dispenser cut out

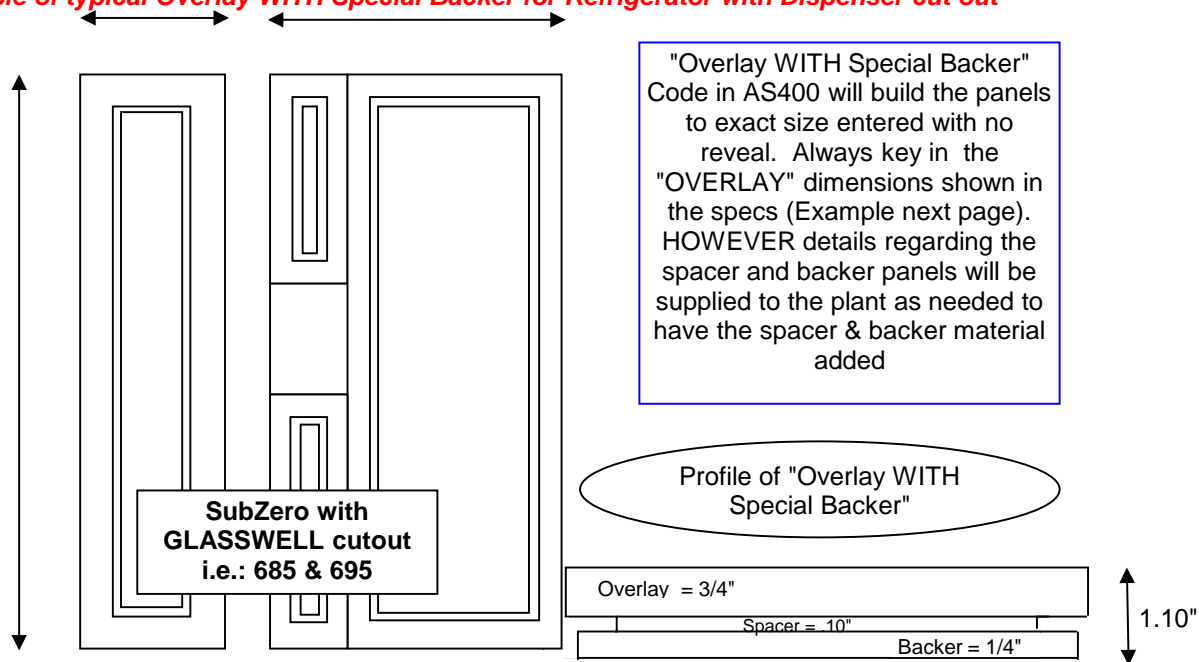

Example - "Side by Side" with dispenser cut out on Refrigerator Door

See Illustration 12 & 13 next page

Refrigerator - Side by Side *with Dispenser Cutout* "Overlay WITH Special Backer (3/4" + 3/8")"

Example of typical Overlay WITH Special Backer for Refrigerator with Dispenser cut out

<p>Model 695</p> <p>Refrigerator Overlay Panel</p> <p>Refrigerator Spacer Panel</p> <p>Refrigerator Backer Panel</p> <p>Freezer Overlay Panel</p> <p>Freezer Spacer Panel</p> <p>Freezer Backer Panel</p> <p>Glasswell Cut-out Dimensions</p> <p>Glasswell Location (Overlay)</p> <p>Glasswell Location (Spacer)</p> <p>Glasswell Location (Backer)</p>	<p>W</p> <p>28" (711)</p> <p>27¹/₁₆" (687)</p> <p>27¹¹/₁₆" (703)</p> <p>18¹/₄" (464)</p> <p>17⁵/₁₆" (440)</p> <p>17¹⁵/₁₆" (456)</p> <p>5⁷/₈" (150)</p> <p>E) 1¹¹/₁₆" (43)</p> <p>E) 1¹/₄" (31)</p> <p>E) 1⁹/₁₆" (29)</p>	<p>H</p> <p>68" (1727)</p> <p>67¹/₁₆" (1703)</p> <p>67¹¹/₁₆" (1719)</p> <p>68" (1727)</p> <p>67¹/₁₆" (1703)</p> <p>67¹¹/₁₆" (1719)</p> <p>12⁷/₁₆" (315)</p> <p>F) 28³/₄" (730)</p> <p>F) 28¹/₄" (718)</p> <p>F) 28⁹/₁₆" (726)</p>	<p>Models 632 and 695</p> <p>Overlay Panel Width</p> <p>Spacer Panel Width</p> <p>Backer Panel Width</p> <p>11" (279) Grille (standard)</p> <p>H</p> <p>Overlay Panel Height</p> <p>Spacer Panel Height</p> <p>Backer Panel Height</p>	<p>W</p> <p>46⁷/₁₆" (1180)</p> <p>45¹/₂" (1156)</p> <p>46¹/₈" (1172)</p> <p>10¹/₄" (260)</p> <p>9⁵/₁₆" (237)</p> <p>9¹⁵/₁₆" (252)</p>
--	---	--	---	--

Glasswell cutouts will require that you order a 3/4" thick SLAB piece for installer to cut dispenser opening. This piece will be assembled with the other custom panels for the Refrigerator door.

Refer to these dimensions to calculate exact panel sizes

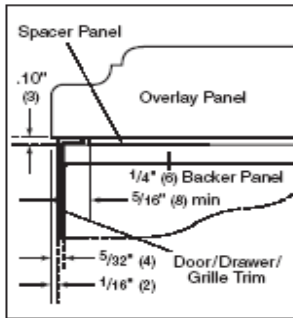

illus. 12

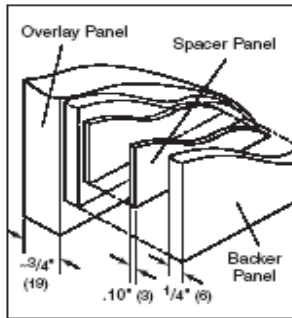

illus. 13

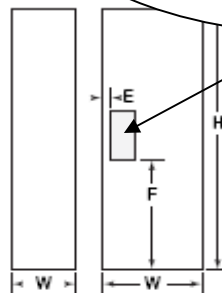

Models 685 and 695

See next page to calculate SLAB piece size as well as doors above, below and next to Glasswell

For grille panel size, use width dimensions listed for your model and height dimensions for grille option. **11" (279) grille is standard.**

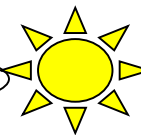

Panel grille is available for all overlay units except Models 601R, 601RG and 601F.

See note on next page to enter **Grill Panel**

Refrigerator - Side by Side *with Dispenser Cutout* "Overlay WITH Special Backer (3/4" + 3/8")

Calculating Glasswell SLAB panel size

Glasswell Cut-out Dimensions	5 7/8" (150)	12 7/16" (315)
Glasswell Location (Overlay)	E) 1 11/16" (43)	F) 28 3/4" (730)
Glasswell Location (Spacer)	E) 1 1/4" (31)	F) 28 1/4" (718)
Glasswell Location (Backer)	E) 1 9/16" (39)	F) 28 9/16" (726)

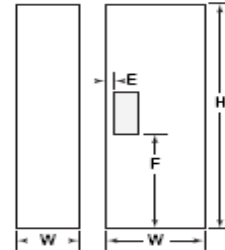

To calculate SLAB width take the "E" overlay dimension x 2

$$1 \frac{11}{16} \times 2 = \underline{3 \frac{3}{8}}$$

Plus the Cut out dimension width of 5 7/8

$$3 \frac{3}{8} + 5 \frac{7}{8} = \underline{9 \frac{1}{4}}$$

9 1/4" is the width of the 3/4" SLAB

"E" Dimension represents the space between the cut out and the edge of the panel. Doubling it allows for a border that matches on the left & right

To calculate SLAB height take the overlay Cut-Out dimension Plus "E" dimension x 2

$$12 \frac{7}{16} + 3 \frac{3}{8} = \underline{15 \frac{13}{16}}$$

15 13/16" is the height of the 3/4" SLAB

Cut-Out Dimension of 12 7/16" represents the height of the glasswell cut out. By adding the "E" dimension 2x's to the height, the top & bottom border will match the left & right

Add item to panel order

Use Panel-Appl__ program to add this SLAB piece

Panel Group: **Side by Side**
 Panel Reveal: **3/4" Finished Slab**
 Appliance MFG: **SubZero**
 Appliance Type: **Glasswell**
 Model Number: **695**

Mark with "SUB" MFG code to tag as Subcomponent so plant will look for this piece to assemble with REF and FREEZER pieces

Width	Height	Panel Type	Price	Need Drawing Y/N	MFG
9 1/4	15 13/16	Leave Blank	320.00	Y	SUB

Make sure to indicate "Y" when it is an ASSEMBLY piece

Refrigerator - Side by Side *with Dispenser Cutout* "Overlay WITH Special Backer (3/4" + 3/8")

Calculating Doors panels above, below and next to Glasswell SLAB

Model 695	W	H
Refrigerator Overlay Panel	28" (711)	68" (1727)
Refrigerator Spacer Panel	27 ¹ / ₁₆ " (687)	67 ¹ / ₁₆ " (1703)
Refrigerator Backer Panel	27 ¹¹ / ₁₆ " (703)	67 ¹¹ / ₁₆ " (1719)
Freezer Overlay Panel	18 ¹ / ₄ " (464)	68" (1727)
Freezer Spacer Panel	17 ⁵ / ₁₆ " (440)	67 ¹ / ₁₆ " (1703)
Freezer Backer Panel	17 ¹⁵ / ₁₆ " (456)	67 ¹¹ / ₁₆ " (1719)
Glasswell Cut-out Dimensions	5 ⁷ / ₈ " (150)	12 ⁷ / ₁₆ " (315)
Glasswell Location (Overlay)	E) 1 ¹¹ / ₁₆ " (43)	F) 28 ³ / ₄ " (730)
Glasswell Location (Spacer)	E) 1 ¹ / ₄ " (31)	F) 28 ¹ / ₄ " (718)
Glasswell Location (Backer)	E) 1 ⁹ / ₁₆ " (39)	F) 28 ⁹ / ₁₆ " (726)

To calculate the lower *Glasswell* door panel (marked 2)

- W The width will match the SLAB of 9 1/4"
- H Take the total height of "F" 28 3/4" less 1 11/16" = 27 1/16"
Bottom REF panel is 9 1/4" x 27 1/16"

To calculate the upper *Glasswell* door panel (marked 1)

- W The width will match the SLAB of 9 1/4"
- H Take the total height of the REF door 68" less the SLAB 15 13/16"
less the lower door 27 1/16"
Upper REF panel is 9 1/4" x 25 1/8"

To calculate the Full Length Door to the right of the Glasswell (marked 3)

- W The overall width of the panel is 28" less the 9 1/4" door above
the glasswell = 18 3/4"
- H The height is exactly the same as the standard spec detail = 68"
Full Length REF door is 18 3/4" x 68"

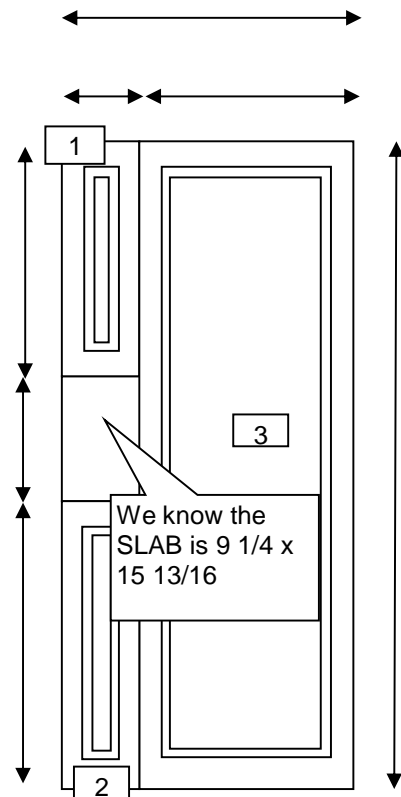

FREEZER & GRILL panels are entered exactly as shown above using OVERLAY dimensions

Refrigerator - Side by Side with Dispenser Cutout
"Overlay WITH Special Backer (3/4" + 3/8")"

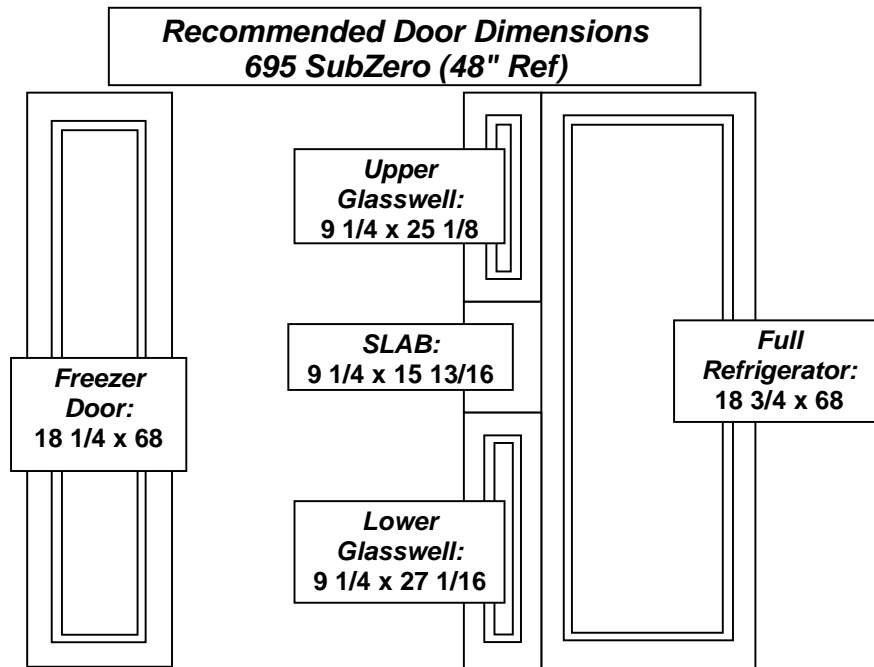

Example - SubZero 695 "Side by Side" with dispenser cut out on Refrigerator Door

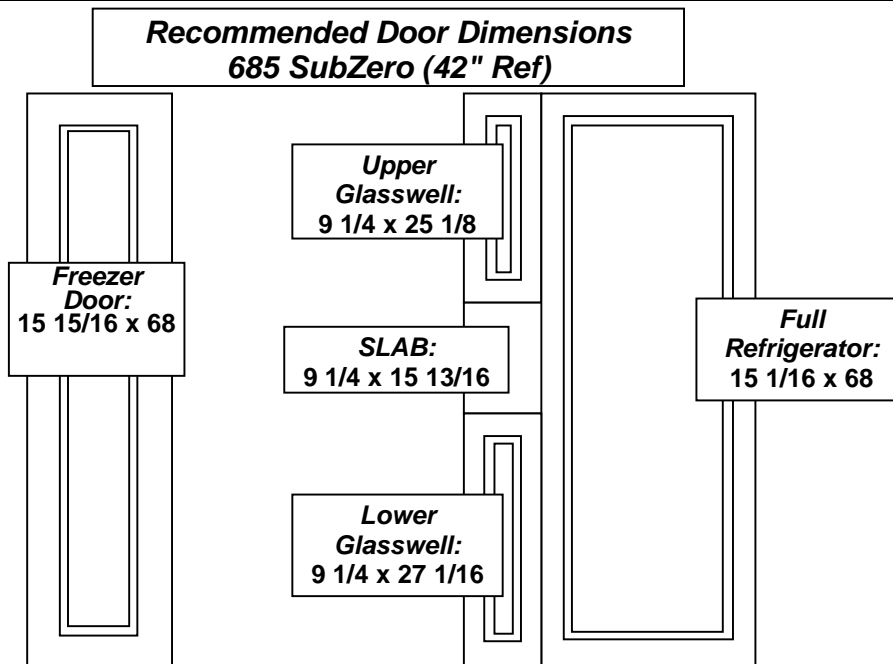

Example - SubZero 685 "Side by Side" with dispenser cut out on Refrigerator Door

Refrigerator - Side by Side *with Dispenser Cutout* "Overlay WITH Special Backer (3/4" + 3/8")

Example of typical Overlay WITH Special Backer for Freezer with Dispenser cut out

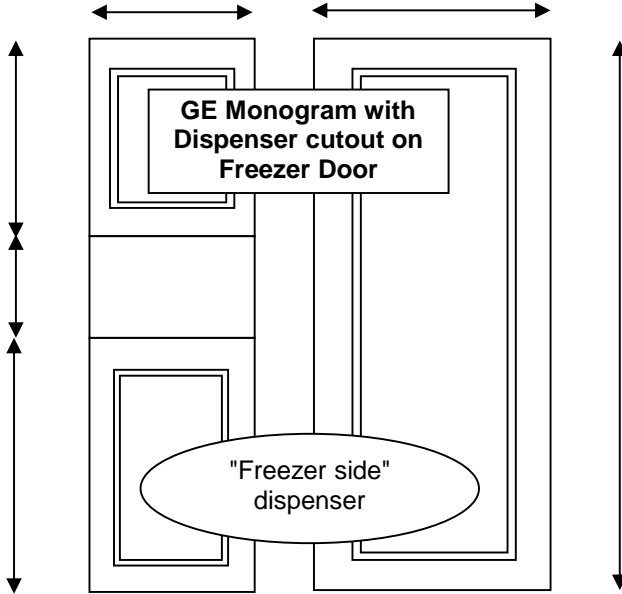

Use same technique as Refrigerator dispenser cut out to calculate dimensions of SLAB piece and door for above and below.

Always add approx. 2" to SLAB piece height to allow for about 1" reveal at the top and bottom of the cut out.
...Make sure to deduct from the doors above and below.

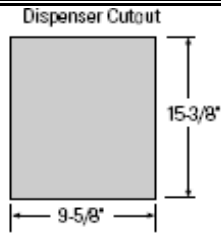
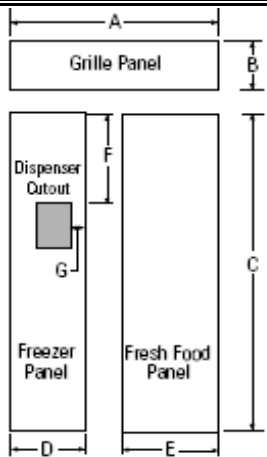

*Cut the dispenser opening after the backer, spacer and overlay panels have been assembled.

36 & 42" GE Monograms will always require a slab piece for the dispenser cut out on the freezer door.

36" Side-by-Side (in inches)

	A	B	C	D	E	F	G
1/4" Backer Panel	33-7/8	9	68-3/8	14-9/16	18-9/16		
.10" Spacer Panel	33	8-3/8	67	13-1/4	17-1/4		
3/4" Overlay Panel	34-1/8	9-1/4	68-5/8	14-13/16	18-13/16	17-15/16	3-1/4

42" Side-by-Side (in inches)

	A	B	C	D	E	F	G
1/4" Backer Panel	39-7/8	9-1/2	68-3/8	14-9/16	24-9/16		
.10" Spacer Panel	39	8-5/8	67	13-1/4	23-1/4		
3/4" Overlay Panel	40-1/8	9-3/4	68-5/8	14-13/16	24-13/16	17-15/16	3-1/4

48" Side-by-Side (in inches)

	A	B	C	D	E	F	G
1/4" Backer Panel	45-7/8	9-1/2	68-3/8	18-9/16	26-9/16		
.10" Spacer Panel	45	8-5/8	67	17-1/4	25-1/4		
3/4" Overlay Panel	46-1/8	9-3/4	68-5/8	18-13/16	26-13/16	17-15/16	5-1/4

*Dispenser Cutout Position

Follow same AS400 directions as Refrigerator side cut out.

48" GE Monogram refrigerators do not require a slab for the dispenser location. Typically the cut out will fit on to the center panel of the door.

1/2" Reveal Panel "Framed" (1/4")

Generic Panel

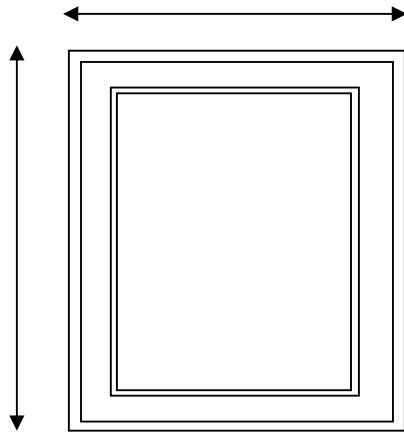

1/2" Reveal Panel

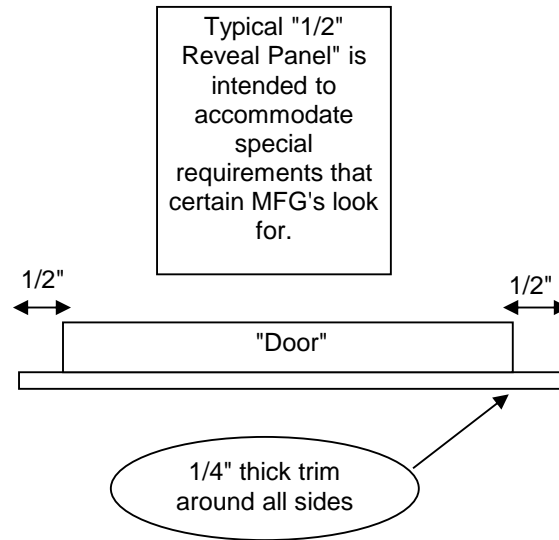

Example of U-Line 1/2" Reveal Panel spec



ÉCHELON

1/4" CUSTOM INSERT PANEL SIZES

2115/CLR2160	27 11/16" H x 14 1/32" W
2175	27 11/16" H x 23 1/32" W
2175DWRR/CO2175DWR	12 15/32" H x 23 1/32" W

- Zero clearance with a flush/flat door panel.
- Door will accept a raised panel. Allow proper clearance, on hinge side when installing a raised panel. Amount of clearance will depend on raised panel thickness.
- The maximum panel thickness when inserted into the door reveal (channel) is 1/4" thick.
- For raised panels the depth of the reveal is 1/4" on both sides and bottom and 1/4" on top.
- Panel not to exceed 20 pounds.

This tells you it is "Framed"

Century will always use a 1/2" reveal on all panels of this type which will work as well.

Appliance Panels: Panel Specifications

"Frame Only"

"Overlay NO Routing" or "Overlay Special Routing" (3/4")

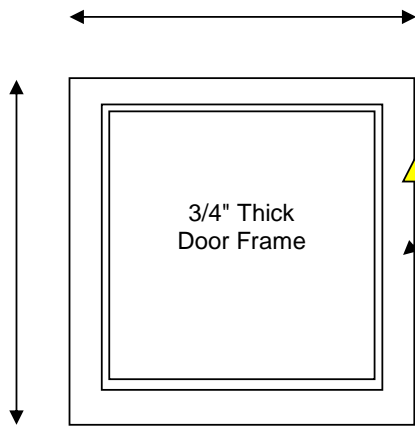

Typical SubZero Frame only

Typical "Frame Only". This is a 3/4" thick Frame made from *matching door rail* to use on glass front refrigerators, wine coolers, etc

We will no longer have to MFG these with a "generic" piece of slab material

Basically this piece looks similar to a glass door. However it is finished on front, outside and inside. The typical detail that holds the glass on a Century door is filled in to make it flat

See Exceptions on Page 3

Common Frame Only routing details

- ▲ There appears to be 3 different possible details that may be needed for the "Frame Only" panel frame. This varies by manufacturer.
- ▲ 1. Calls for the back and side of the frame to be flat without any detail on it. **OR**
- ▲ 2. For routing typical of the SubZero style routing (see overlay with routing REF pages for details) **OR**
- ▲ 3. For routing on the back of the frame instead of the sides to allow it to lay flat against the glass frame on the appliance.

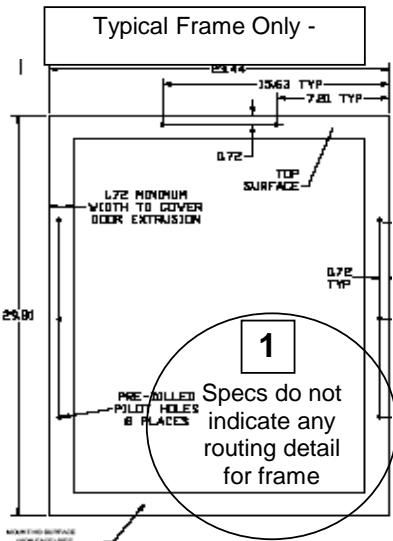

Typical Frame Only that does not require any routing detail

Use "Overlay No Routing" code on your order

Example From:

Marvel 24" Designer Door

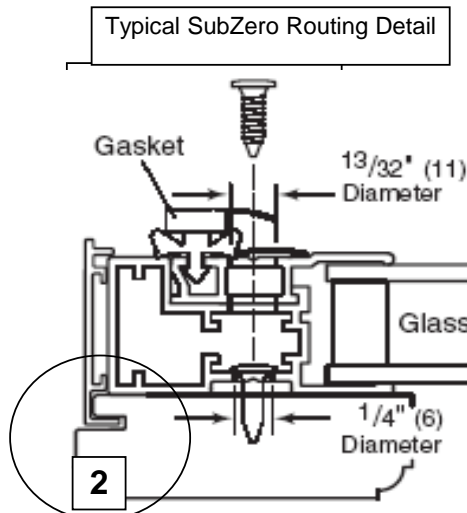

Typical Frame Only that requires routing detail on the sides of the frame

Use "Overlay Special Routing" code on your order

Example From:

SubZero 430

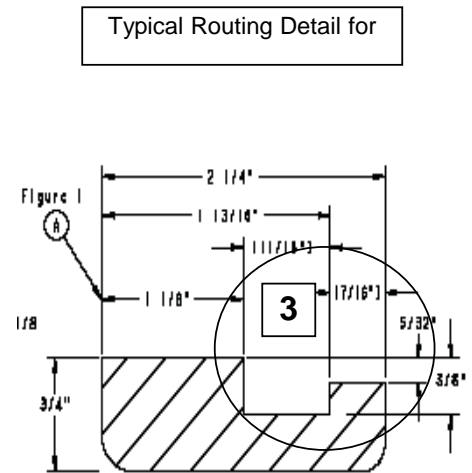

Typical Frame Only that requires routing detail only on the back of the frame

Use "Overlay Special Routing" code on your order

Example From:

U-Line 2175 & 2115

Appliance Panels: Panel Specifications

"Frame Only"

"Overlay NO Routing" or "Overlay Special Routing" (3/4")

"Frame Only"

"Overlay no Routing" or "Overlay Special Routing"

All "Frame Only" panels will be "filled" in as shown below, further routing detail "Overlay no Routing" or "Overlay Special Routing" will depend on the MFG specs that are provided. See details below.

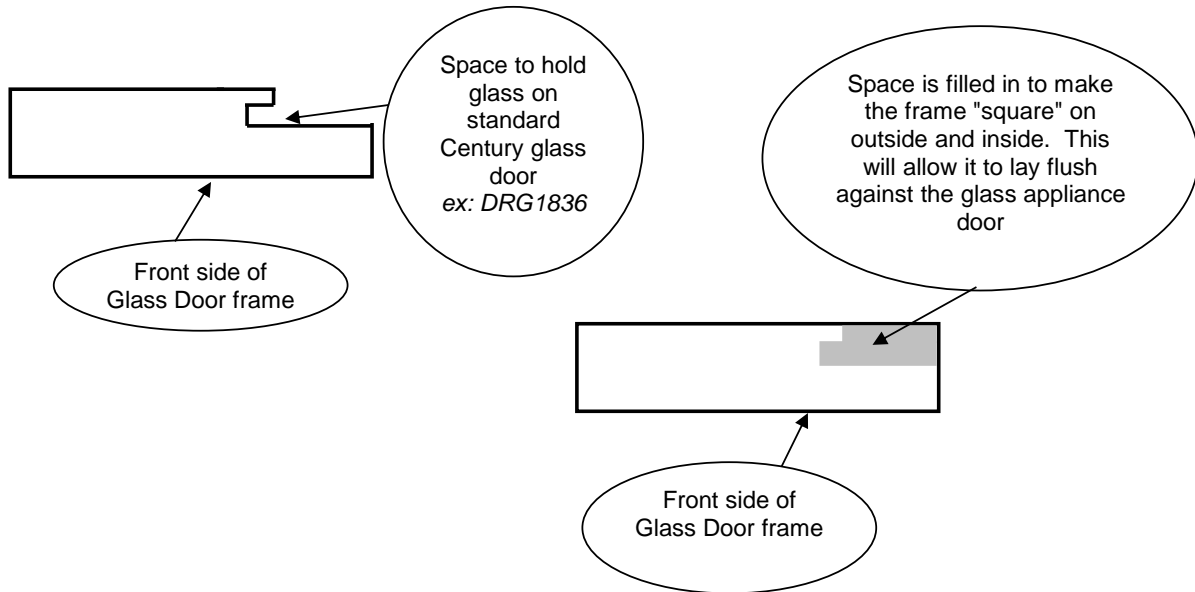

Known exceptions for MFG of frame only panels

Overlay Frame—Rear View

Create the custom overlay frame using the dimensions shown.

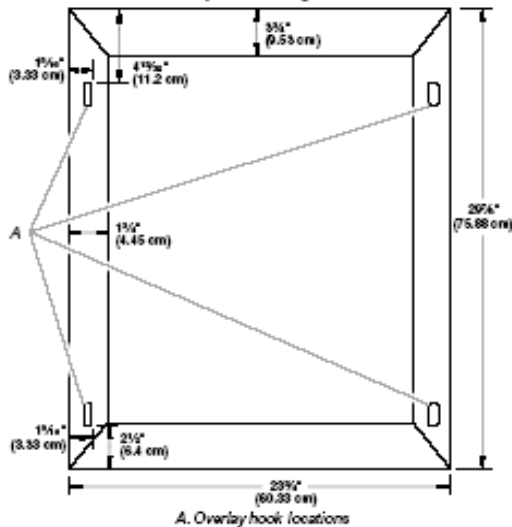

Several *Kitchen Aid* models require a wider Rail (3 3/4") than Stile (1 3/4"). Because you can't miter that frame correctly, Century will not be able to MFG frames with these requirements using a Door Rail. A Slab Filler piece will have to be used to make this type of frame

"Trash Compactor / Compact Fridge / Wine Cooler" "Framed" (1/4")

Trash Compactor

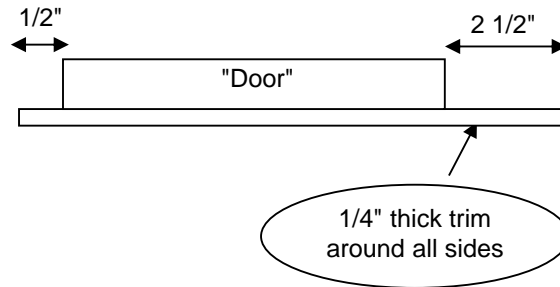
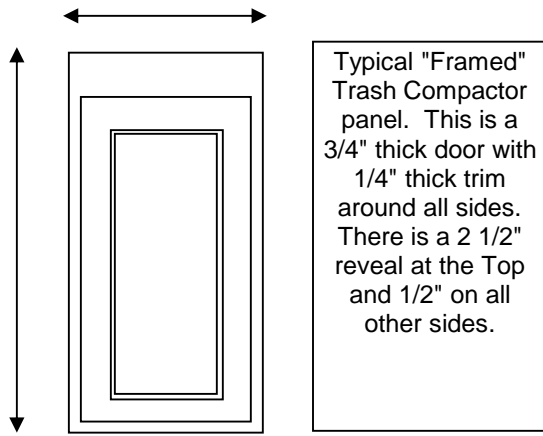

Typical GE Profile Trash Compactor panel

Compact Refrigerator Handle on Top

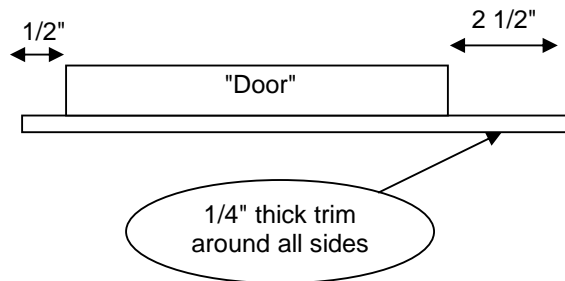
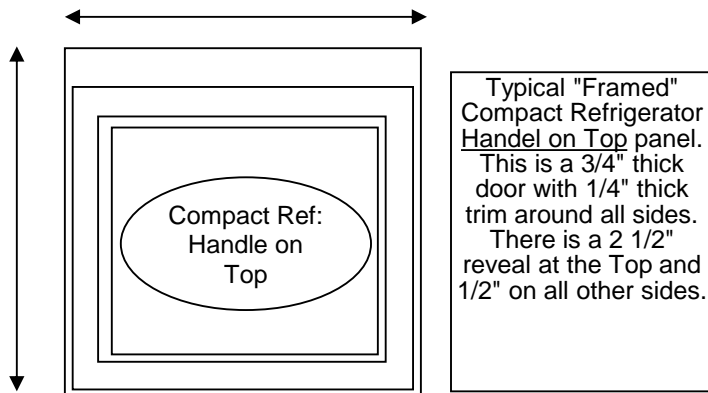

Typical Compact Refrigerator - Handle on Top

Compact Refrigerator Handle on Side

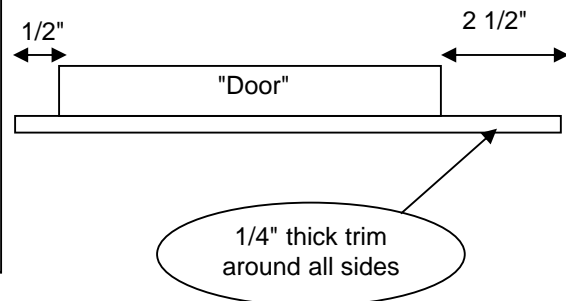
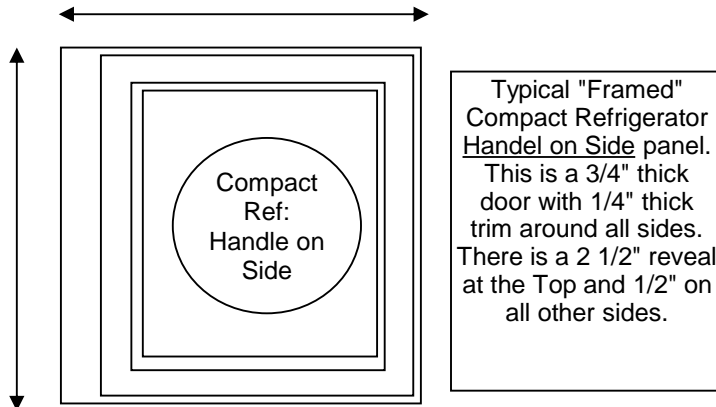

Typical Compact Refrigerator - Handle on Side

Appliance Panels: Panel Specifications

"Trash Compactor / Compact Fridge / Wine Cooler" "Framed" (1/4")

Entering "Trash Compactor" or "Compact Ref..." in AS400

Key in	QTY	MFG	STYLE	ITEM	DESCRIPTION
	1	CHS	HA	PANEL-APPL1	HAMPTON ANTIQUE

Panel Group: Trash Compactor
Panel Reveal: Frame
Appliance MFG: GE
Appliance Type: Profile
Model Number: 56985

Width	Height	Panel Type	Price	Need Drawing Y/N
15	30	<i>Leave Blank</i>	150.00	N

Follow same details for Compact Refrigerators,
however **ALWAYS CLARIFY WHERE THE
HANDLE LOCATION IS** so the reveal is located
in the correct place and it will operate properly