

- ***Index***
- ***Pricing***
- ***Panel Specifications***
- ***Notes***

# Appliance Panels : Pricing

Free-standing 36"W x 70"H	2 PANEL
	3 PANEL
Built-ins 36"W x 84"H	2 PANEL
	3 PANEL
	Add for a Grille Panel
Built-ins 42"W x 84"H	2 PANEL
	3 PANEL
	Add for a Grille Panel
Built-ins 48"W x 84"H	2 PANEL
	3 PANEL
	Add for a Grille Panel
Dishwasher Panels	
Warming Drawer Panels	
Trash Compactor Panels	
Wine Refrigerator Panels	
Under Counter Refrigerator Panels	

**\*\*Please note that Grille Panels are now raised instead of flat**

**\*\*Not available in Value or Gatehouse Series**

Item codes
PANEL-APPL1
PANEL-APPL2
PANEL-APPL3
PANEL-APPL4
PANEL-APPL5
PANEL-APPL6
PANEL-APPL7
PANEL-APPL8
PANEL-APPL9

---

---

**Dishwasher**  
**"Framed" (1/4")**

---

---

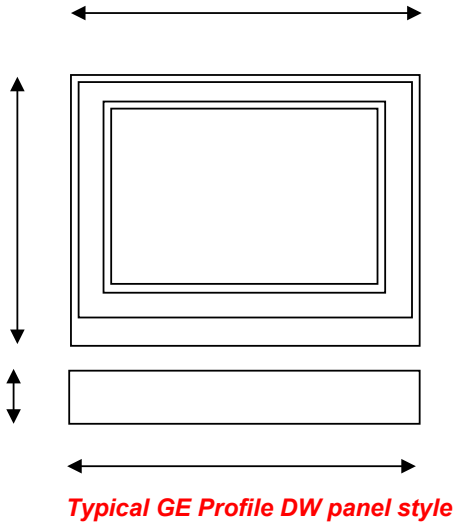

Typical "Framed" Dishwasher panel. This is a 3/4" thick door with 1/4" thick trim around all sides. There is a 2 1/2" reveal at the bottom and 1/2" on all other sides.

The bottom access panel is always 1/4" flat material.

NOTE: This panel is sometimes a different width than the top panel.

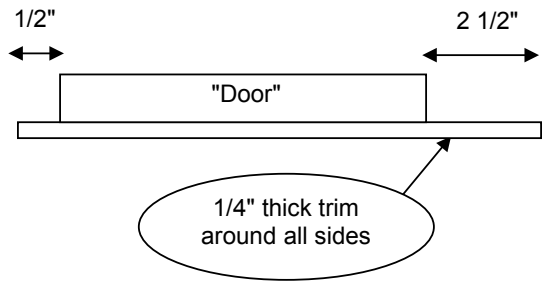

---

---

**Dishwasher**  
**"Overlay NO Routing" (3/4")**

---

---

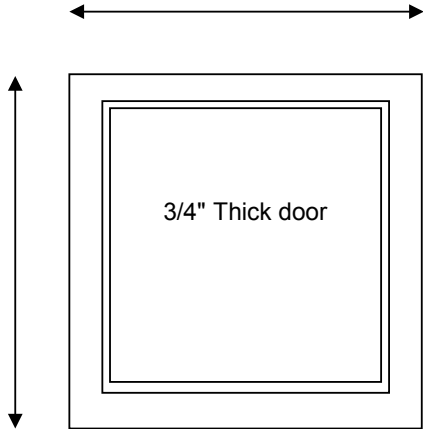

Typical "Overlay" Dishwasher panel. This is a 3/4" thick door

*Typical GE Monogram DW panel style*

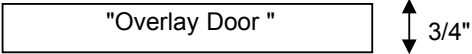

## Dishwasher - Double Drawer "Overlay NO Routing" (3/4")

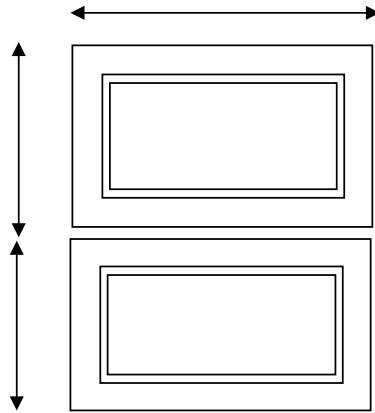

Typical Double Drawer appliance. Available for Single or Double drawer DW's, Refrigerators/Freezers etc. These are always Overlay Doors however the routing detail (if any) will depend on the specs

Typical Double Drawer DW, Ref or Freezer etc.

Most Manufacturers supply the exact panel sizes needed

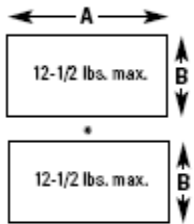

3/4" Overlay Panel Dimensions (in inches)		
	A (Width)	B (Height)
1/4" Backer	23-3/16"	14-11/16"
0.10" Spacer	22-1/2"	14-3/16"
3/4" Overlay	23-5/8"	15-1/16"

\*Maintain a 1/4" min. gap between top and bottom drawer panels.

Assemble overlay panels with glue and screws.

- Center spacer panel on the backer panel, left to right and top to bottom. Secure the panels with glue.
- Center the spacer/backer panel on the overlay panel. Secure with glue and screws. Countersink all screws into the backer panel.

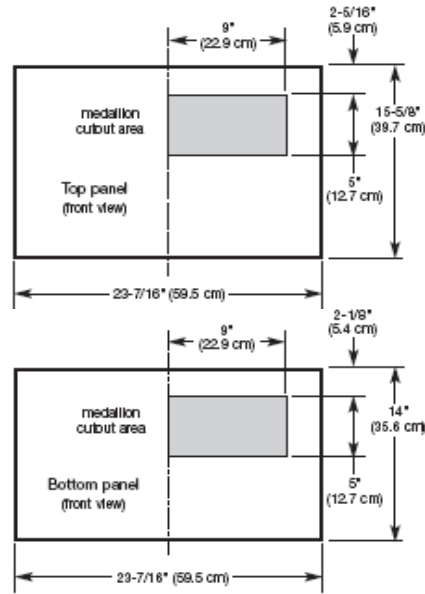
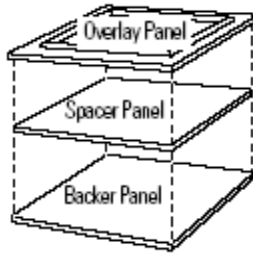

GE Monogram Double Drawer Refrigerator

This would be an example of "Overlay Special Routing"

Kitchen Aid typical Double Drawer Dishwasher

This would be an example of "Overlay No Routing"

Take note of dimensional difference between overlay size and backer size:  
3/8" difference for HEIGHT  
7/16" difference for WIDTH

Always be sure to inform your customers that we can not cut out for "medallion" area on any panel

## Dishwasher - Double Drawer "Overlay NO Routing" (3/4")

Typical Fisher & Paykel Double Drawer Dishwasher

The Door and Toe Kick Panels of the DishDrawer® can be made to match your kitchen cabinetry. This diagram, with the addition of your own measurements will help you calculate the required panel sizes.

### CABINERY ALIGNMENT

The following calculations assume:

The top of the Upper Panel is to be aligned with the top of the adjacent cabinetry. The final panel/cabinetry alignment is achieved by adjusting the DishDrawer®'s feet

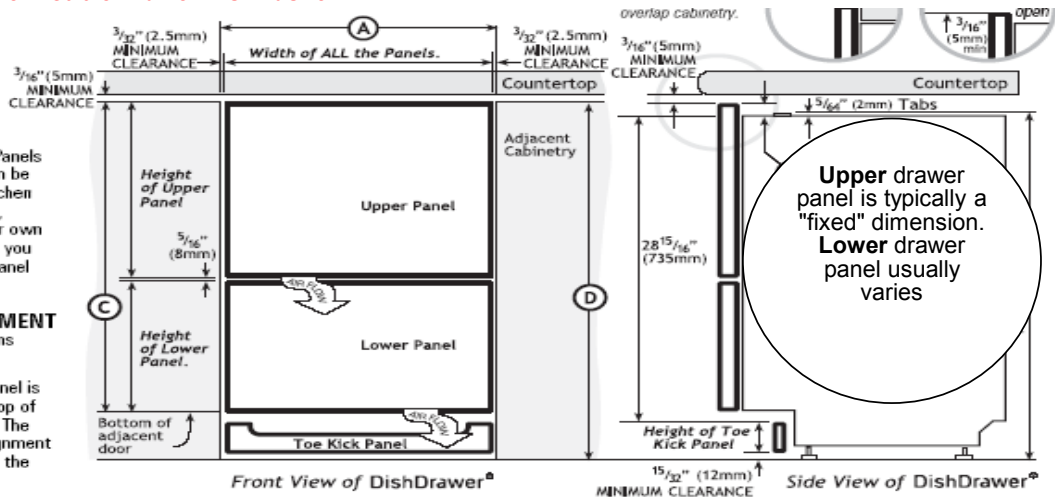

### WIDTH OF ALL PANELS

Measure (A) the width between adjacent door/drawer fronts and write it in the first box below, then complete the equation. For example:

$$\textcircled{A} 24 \frac{1}{4} (616\text{mm}) - 2 \times \frac{3}{32} (2.5\text{mm}) \text{ door clearance} = 24 \frac{1}{16} (611\text{mm}) \text{ width of all panels}$$

$$\textcircled{A} 24 - 2 \times \frac{1}{8} \text{ door clearance } (\frac{3}{32} (2.5\text{mm}) \text{ MIN}) = 23 \frac{3}{4} \text{ width of all panels } (23 \frac{7}{16} (595\text{mm}) \text{ MIN})$$

### HEIGHT OF UPPER PANEL

For example:  $15 \frac{5}{8} (398\text{mm}) \text{ standard height} + \textcircled{B} 0\text{mm} \text{ door extension} = 15 \frac{5}{8} (398\text{mm}) \text{ height of upper panel}$

$$15 \frac{5}{8} (398\text{mm}) \text{ standard height} + \textcircled{B} 0 \text{ door extension } (0" \text{ recommended}) = 15 \frac{5}{8} \text{ height of upper panel}$$

### HEIGHT OF LOWER PANEL

Measure (C) door/drawer height (or equivalent) and write it in the first box below, then complete the equation. For example:

$$\textcircled{C} 30 (762\text{mm}) - 15 \frac{5}{8} (398\text{mm}) \text{ height of upper panel} - \frac{5}{16} (8\text{mm}) \text{ air gap} = 14 \frac{1}{16} (356\text{mm}) \text{ height of lower panel}$$

$$\textcircled{C} 29 \frac{13}{32} \text{ MIN } 28 \frac{1}{4} (717.5\text{mm}) + \textcircled{B} - 15 \frac{5}{8} \text{ height of upper panel} - \frac{5}{16} (8\text{mm}) \text{ gap between panels} = 13 \frac{15}{32} \text{ height of lower panel } (12 \frac{17}{64} (311.5\text{mm}) \text{ MIN})$$

CARRIAGE HOUSE

Use same calculation for top drawer in CHS doors. However use different formula for the lower drawer.

## Dishwasher - Double Drawer "Overlay NO Routing" (3/4")

*Typical Fisher & Paykel Single Drawer Dishwasher*

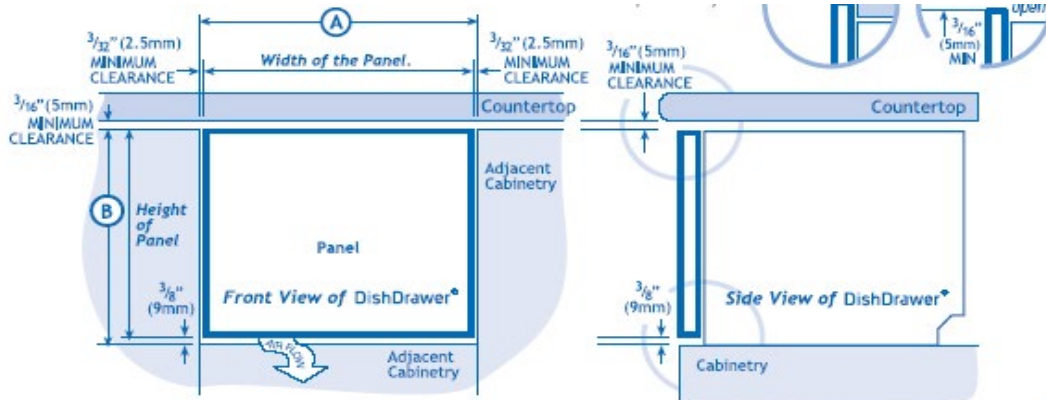

**⚠ WARNING**  
Be sure the Product is not plugged in.

The Door of the DishDrawer\* can be made to match your kitchen cabinetry. This diagram, with the addition of your own measurements will help you calculate the required panel sizes.

Installer must leave 3/8" (9mm) gap for correct ventilation.

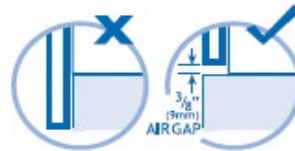

### WIDTH OF THE PANEL

Measure **(A)** the width between adjacent door/drawer fronts and write it in the first box below, then complete the equation.

For example:  $(A) 24\frac{1}{4}" (616\text{mm}) - 2 \times \frac{3}{32}" (2.5\text{mm}) = 24\frac{1}{8}" (611\text{mm})$   
door clearance                      panel width

**24** - 2x **1/8** = **23 3/4**  
door clearance (3/32" (2.5mm) MIN)                      panel width (23 7/16" (595mm) MIN)

### HEIGHT OF THE PANEL

Measure **(B)** door/drawer height (or equivalent) and write it in the first box below, then complete the equation.

For example:  $(B) 16" (407\text{mm}) - \frac{3}{8}" (9\text{mm}) = 15\frac{5}{8}" (398\text{mm})$   
air gap                      panel height

**16** - **3/8** = **15 5/8**  
gap between panels                      panel height (15 5/8" (398mm) MIN)

*Note: When the top of the DishDrawer\* has to be lower than the adjacent cabinetry, the Panel can be increased in height.*

**⚠ WARNING!**  
The air vent between the Panel and the adjacent cabinetry must not be covered. An air gap of 3/8" (9mm) MUST be provided.

Use same calculation for the panel width as the double drawer panel.  
Suggest to use the same height drawer as the standard height of the double drawer above. This can be used for **CHS** product.

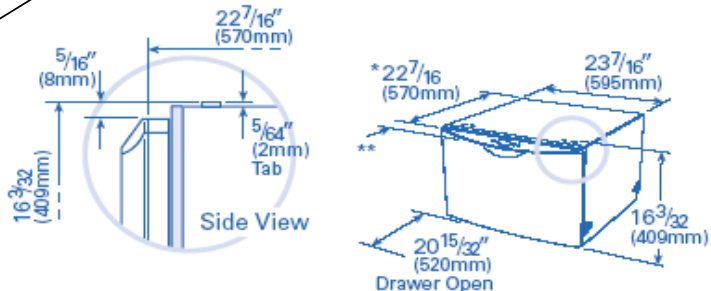

**Refrigerator - Side by Side  
"Framed" (1/4")**

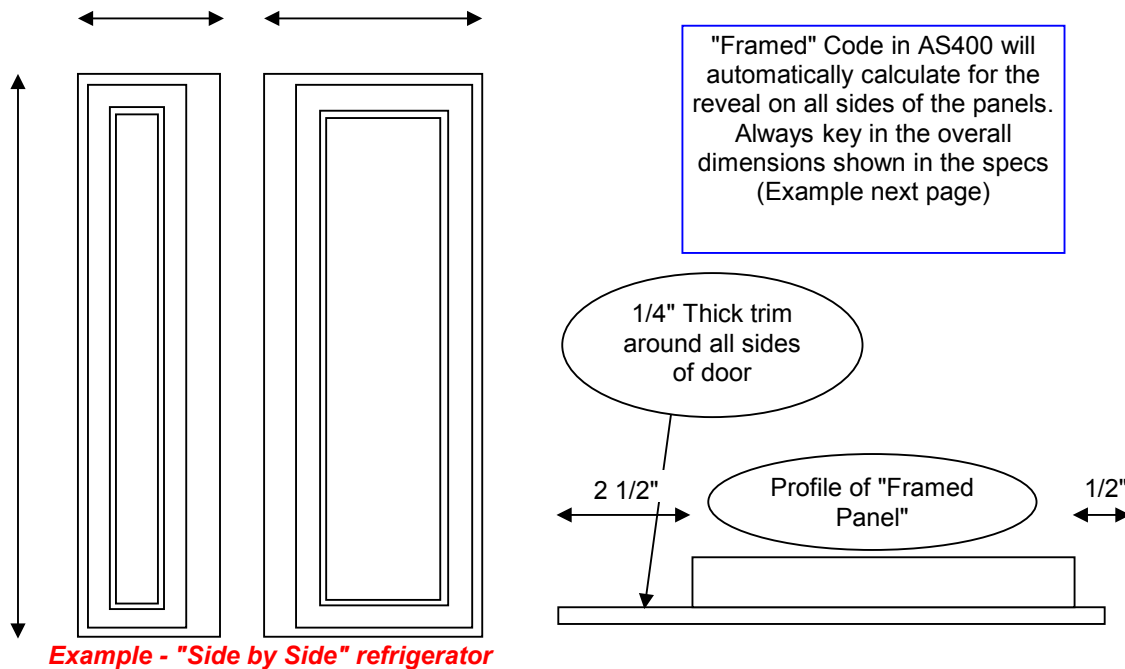
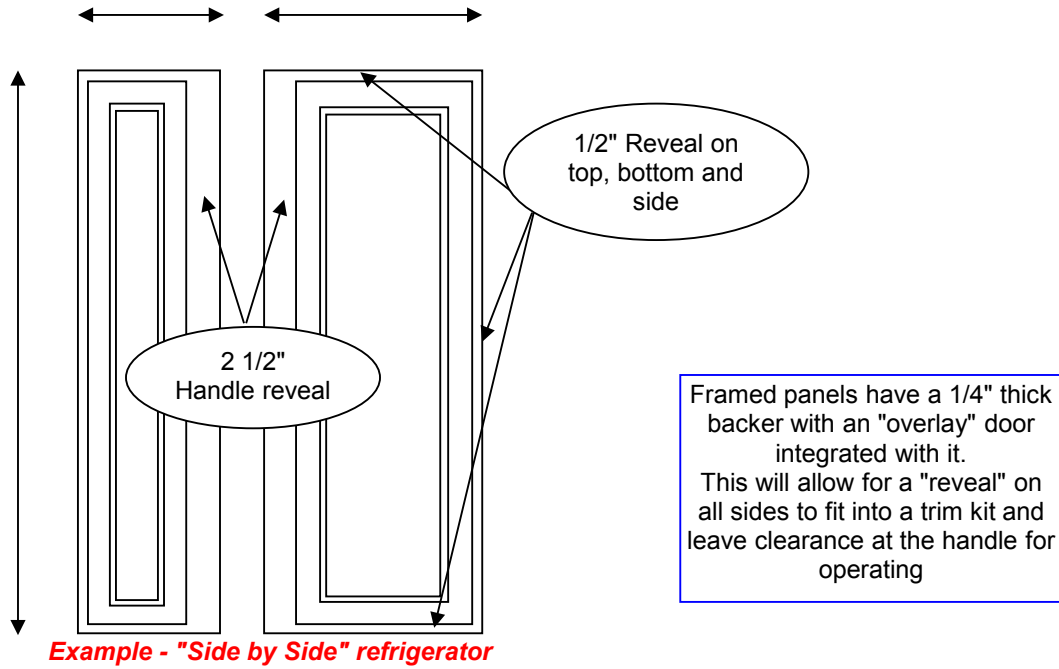



**Refrigerator - Side by Side  
"Framed" (1/4")**

*Example of typical GE Profile Side by Side spec*

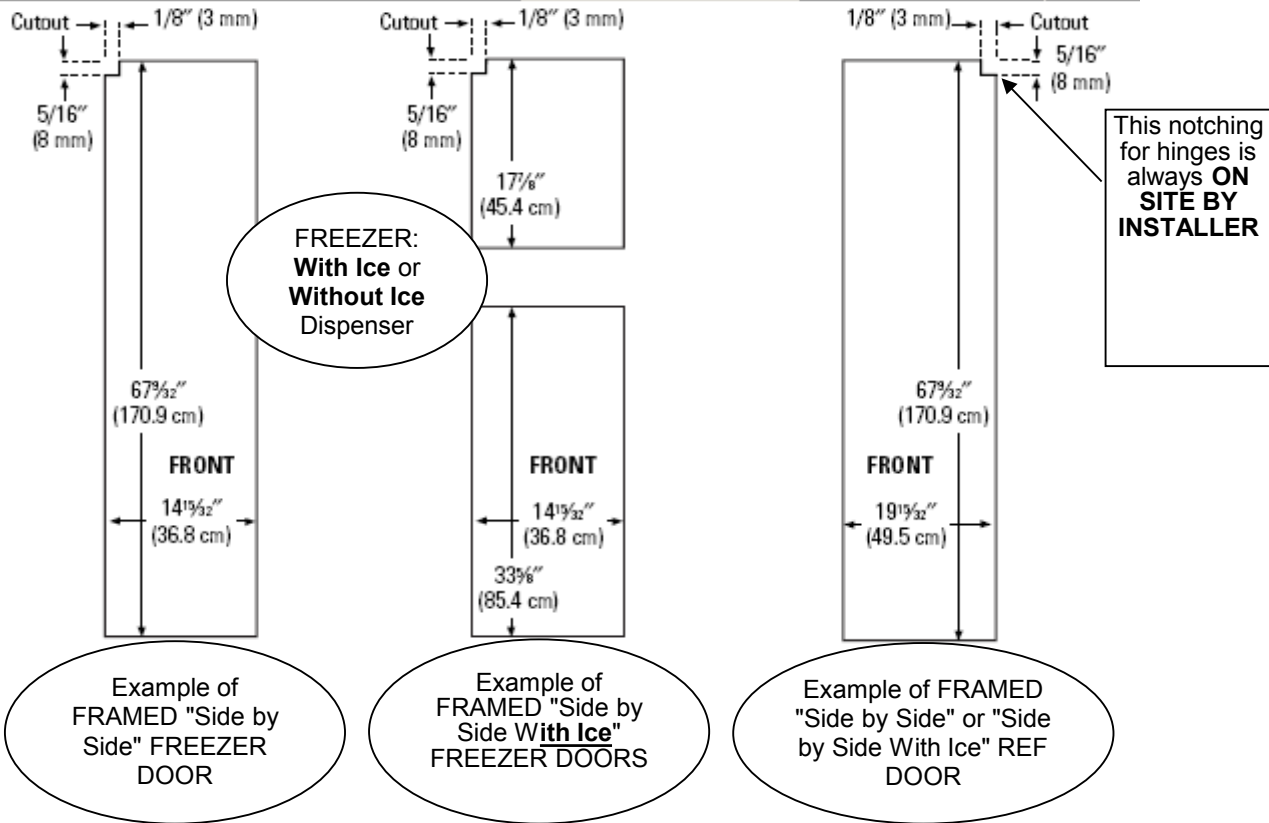

**NOTE:**

Always be sure to clarify with your customer if they are getting a dispenser or not.

Panels 1/4" thick or less

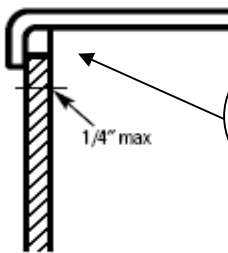

This is the typical information you will find in the spec pages. It is saying that the maximum thickness is 1/4". This is what a FRAMED appliance panel will have on all sides to fit into the trim kit.

---

---

**Refrigerator - Refrigerator over Freezer**  
**"Overlay NO Routing" (3/4")**

---

---

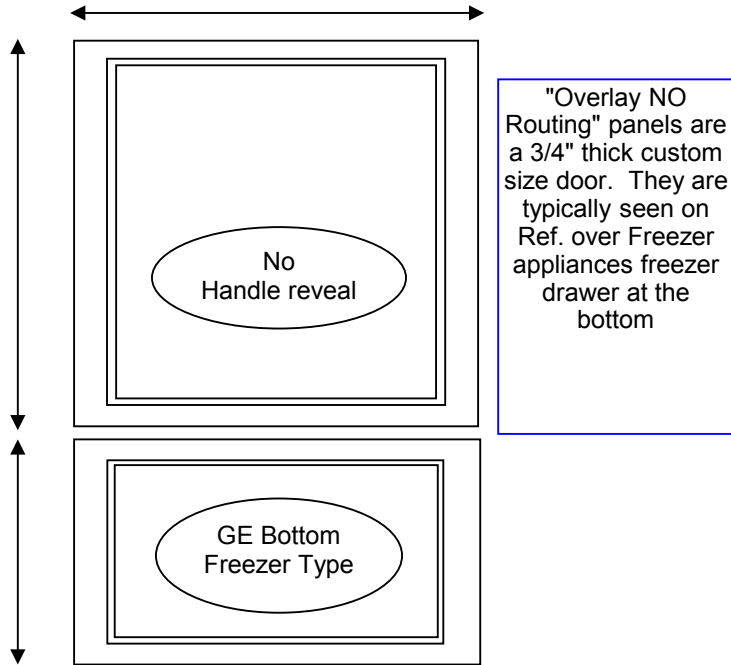

**Example - "Refrigerator over Freezer"**

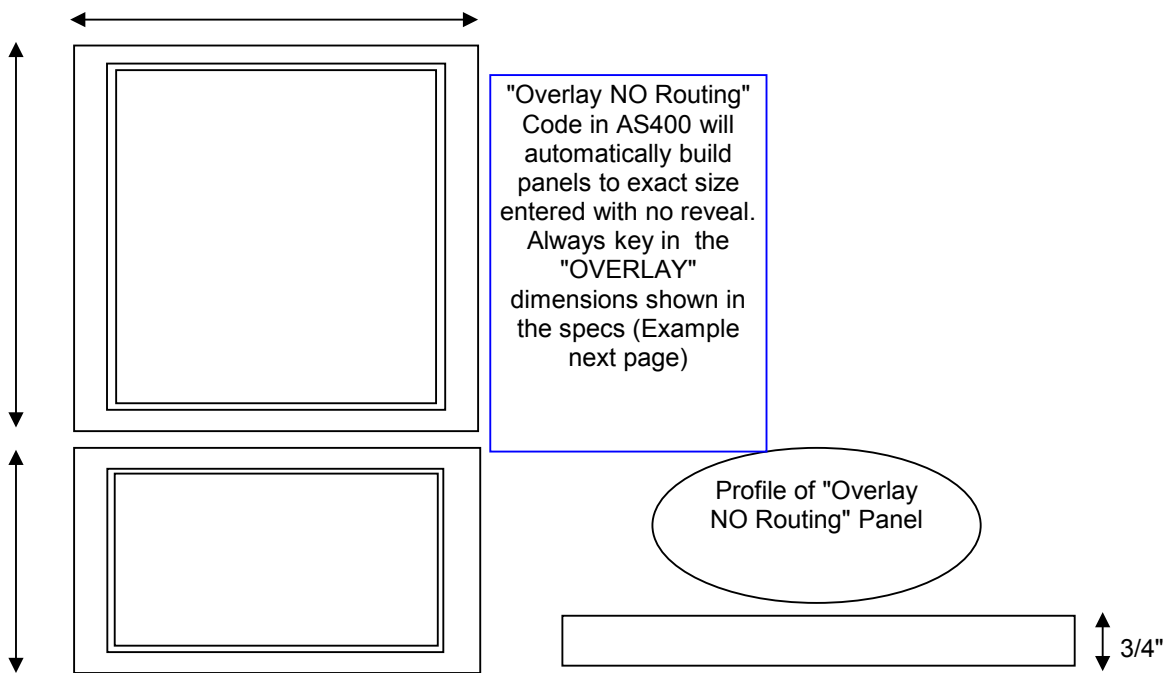

**Example - "Refrigerator over Freezer"**

---

---

**Refrigerator - Refrigerator over Freezer**  
**"Overlay NO Routing" (3/4")**

---

---

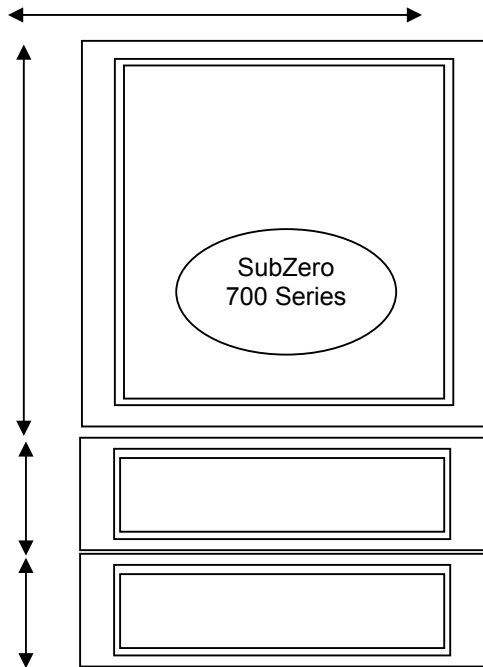

"Overlay NO Routing" panels are a 3/4" thick custom size door. They are typically seen on Ref. over Freezer appliances like the SubZero 700 series with the freezer drawers at the bottom

**Example - "Refrigerator over Freezer drawers"**

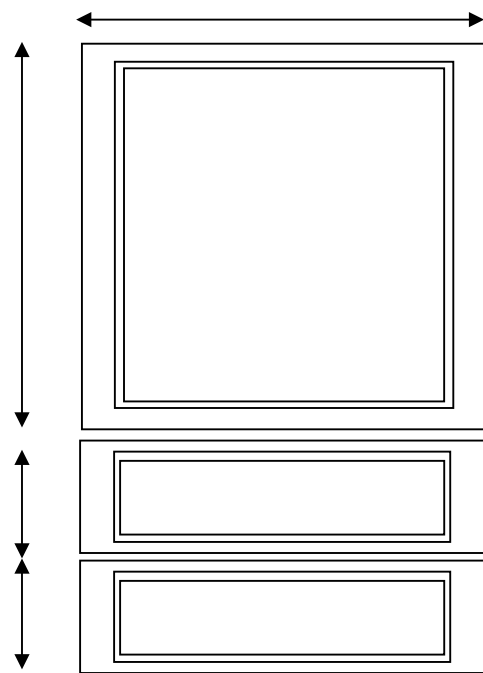

"Overlay NO Routing" Code in AS400 will automatically build panels to exact size entered with no reveal. Always key in the "OVERLAY" dimensions shown in the specs (Example next page)

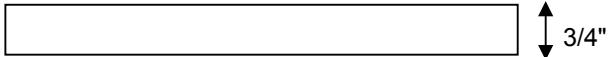
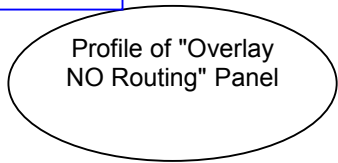

**Example - "Refrigerator over Freezer drawers"**

---

---

**Refrigerator - Refrigerator over Freezer**  
**"Overlay NO Routing" (3/4")**

---

---

*Example of typical GE Refrigerator*

Custom Door Panel Dimensions  
Using Trim Kits ZKTC36L or ZKTC36R  
3/4" thick panel with kit supplied handle

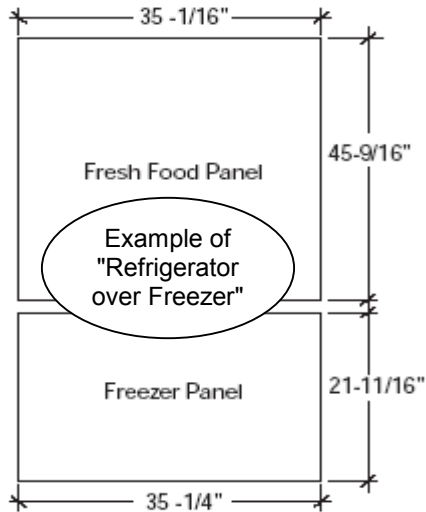

**ZIS36N Bottom Mount Refrigerator**

- The ZKTC36L (or ZKTC36R) trim kit provides for the installation of 3/4" thick custom door and grille panels, using the supplied handle. Cut panels to size and install.

Always be careful to clarify which handles are being supplied because it could affect the panel sizes

**Refrigerator - Refrigerator over Freezer**  
**"Overlay NO Routing" (3/4")**

*Example of typical SubZero 700 Series Refrigerator (shown available in 27" or 36" width appliance)*

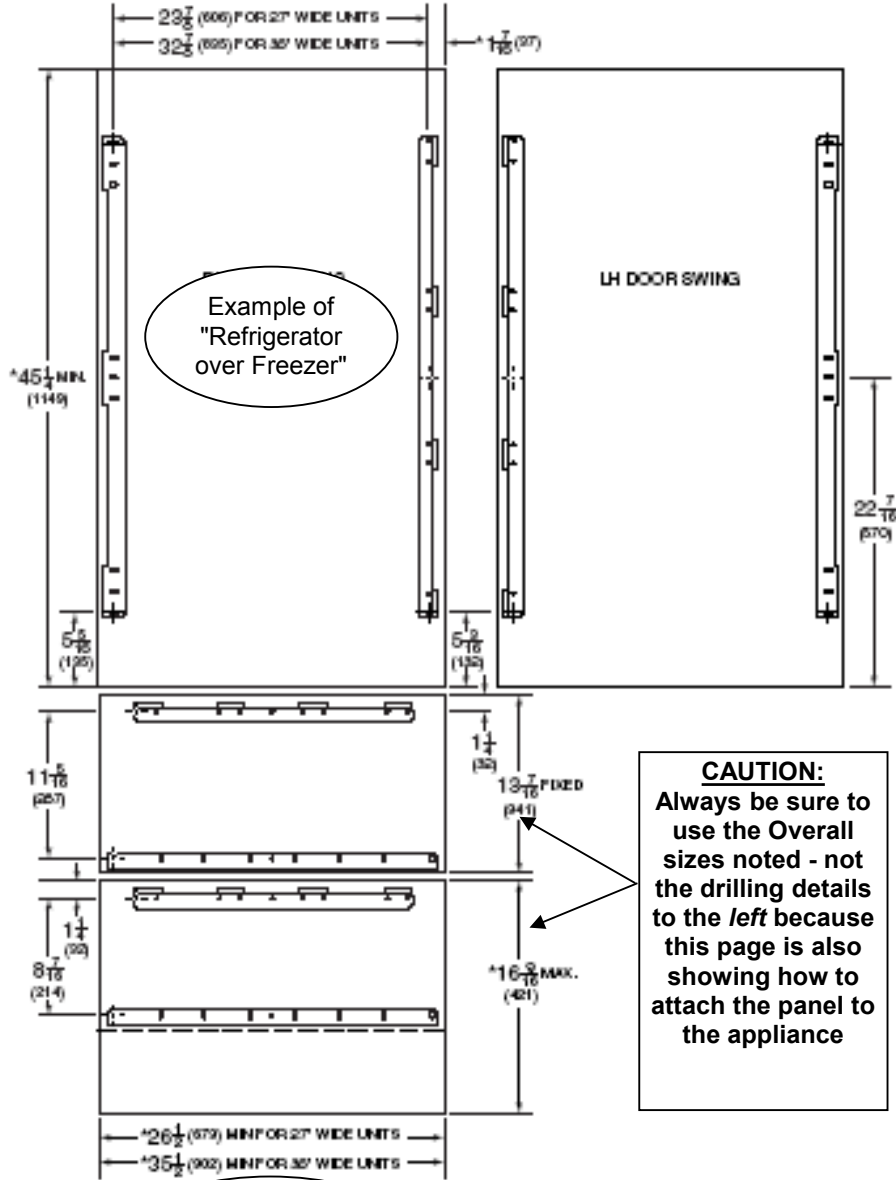

For *drawer only* undercounter units use the dimensions shown for just the 2 drawers

**Refrigerator - Side by Side  
"Overlay WITH Routing" (3/4")**

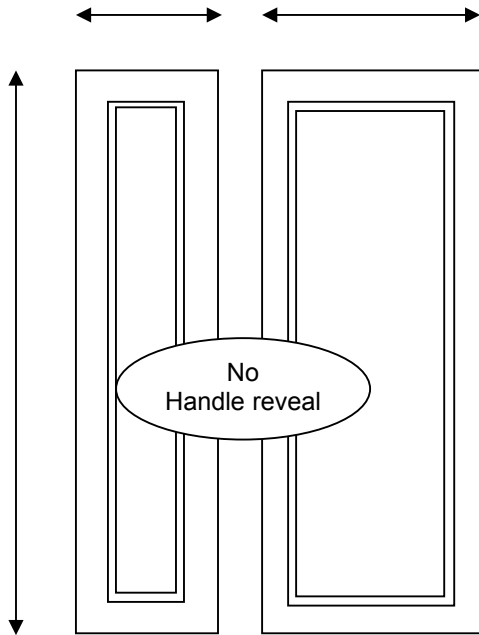

*Example - "Side by Side" refrigerator*

"Overlay With Routing" panels are a 3/4" thick custom size door with a routing detail around all sides of the door to act as the "spacer" and "backer" panels

**Example of typical Overlay WITH Routing Refrigerator**

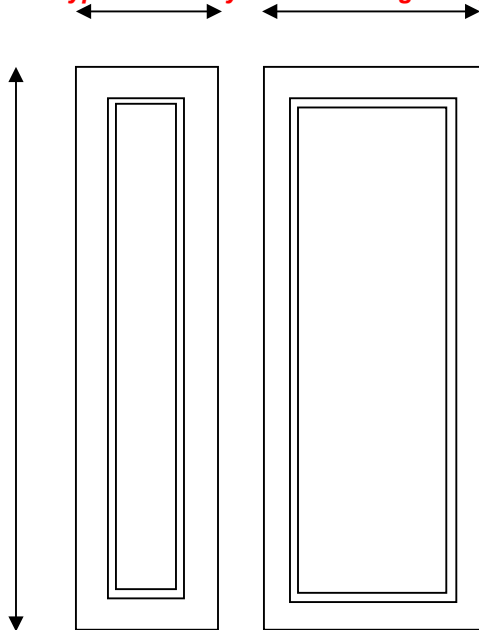

*Example - "Side by Side" refrigerator*

"Overlay WITH Routing" Code in AS400 will build the panels to exact size entered with no reveal. Always key in the "OVERLAY" dimensions shown in the specs (Example next page). HOWEVER details regarding the routing dimensions may need to be submitted to ensure proper fit.

Profile of "Overlay WITH Routing" Panel

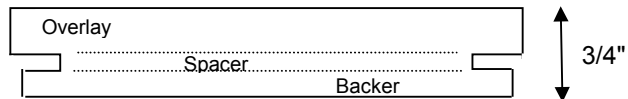

*See Illustration 12 & 13 next page*

## Refrigerator - Side by Side "Overlay WITH Routing" (3/4")

Example of typical Overlay WITH Routing Refrigerator

Model 642	W	H		
Refrigerator Overlay Panel	24 <sup>5</sup> / <sub>16</sub> " (618)	68" (1727)		
Refrigerator Spacer Panel	23 <sup>3</sup> / <sub>8</sub> " (594)	67 <sup>1</sup> / <sub>16</sub> " (1703)		
Refrigerator Backer Panel	24" (610)	67 <sup>11</sup> / <sub>16</sub> " (1719)		
Freezer Overlay Panel	15 <sup>15</sup> / <sub>16</sub> " (405)	68" (1727)		
Freezer Spacer Panel	15" (381)	67 <sup>1</sup> / <sub>16</sub> " (1703)		
Freezer Backer Panel	15 <sup>5</sup> / <sub>8</sub> " (397)	67 <sup>11</sup> / <sub>16</sub> " (1719)		
			<b>Models 642 and 685</b>	<b>W</b>
			Overlay Panel Width	40 <sup>7</sup> / <sub>16</sub> " (1027)
			Spacer Panel Width	39 <sup>1</sup> / <sub>2</sub> " (1003)
			Backer Panel Width	40 <sup>1</sup> / <sub>8</sub> " (1019)
			<b>11" (279) Grille (standard)</b>	<b>H</b>
			Overlay Panel Height	10 <sup>1</sup> / <sub>4</sub> " (260)
			Spacer Panel Height	9 <sup>5</sup> / <sub>16</sub> " (237)
			Backer Panel Height	9 <sup>15</sup> / <sub>16</sub> " (252)

Key In Overlay dimensions on your order

Panel specifications are for Built-In overlay (O) models.

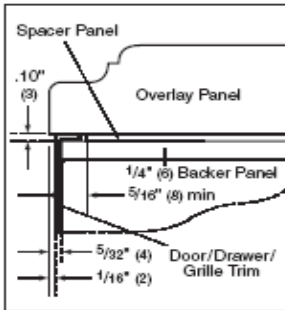

Illus. 12

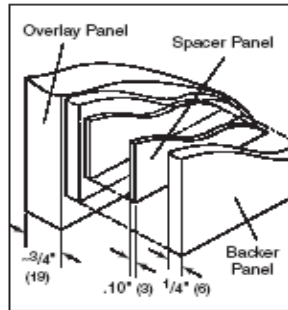

Illus. 13

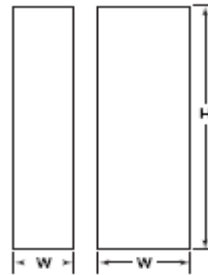

Models 661, 642 and 632

For grille panel size, use width dimensions listed for your model and height dimensions for grille option. 11" (279) grille is standard.

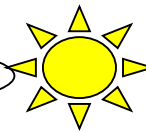

Panel grille is available for all overlay units except Models 601R, 601RG and 601F.

See note on next page to

Whenever you see 3/4" Thick panels indicated in your panel specs, that is the clue that you need to either use Overlay WITH or NO Routing. Most SubZero's work with our "WITH Routing" code but some MFG's require special details. See "Special Routing Details" pages for more info.

**Refrigerator - French Doors**  
**"Overlay WITH Routing" for French Doors Style (3/4")**

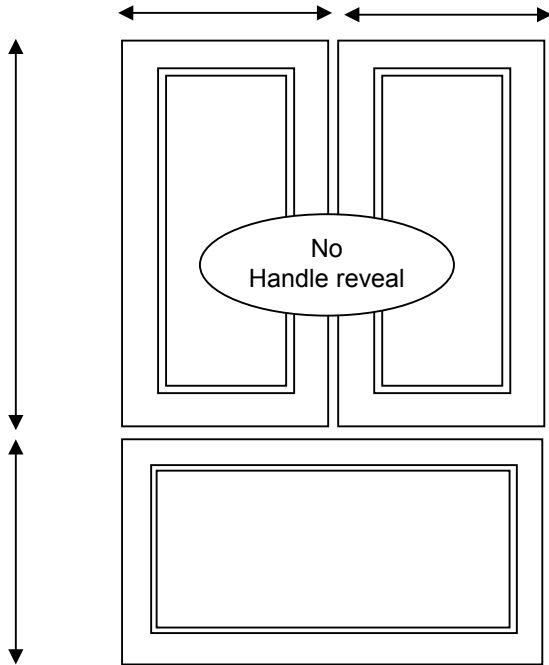

*Example - "French Door style Refrigerator"*

"Overlay WITH Routing" for French Door style Refrigerators are a 3/4" thick custom size door with **special routing placement**. The *Refrigerator* gets routed on the Top, Bottom and NON-hinge sides. The *Freezer* gets routed on all 4 sides

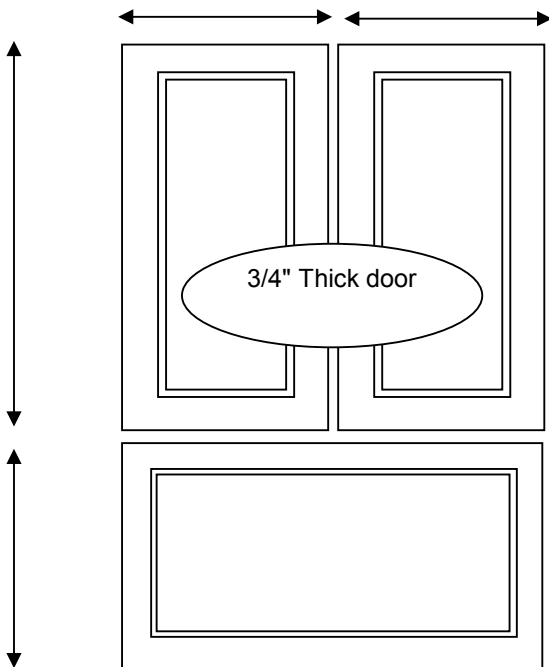

"Overlay NO Routing" Code in AS400 will automatically build panels to exact size entered with no reveal. Always key in the "OVERLAY" dimensions shown in the specs (Example next page)

Profile of "Overlay WITH Routing" Panel for French Door Ref.

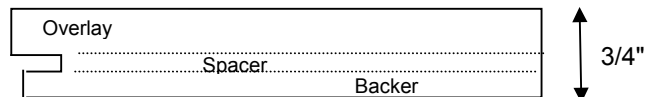



---

---

## Refrigerator - French Doors

### "Overlay WITH Routing" for *French Doors Style (3/4")*

---

---

NOTE: Although routing detail will show thru on the Handle side, the bottom of the trim kit covers the routed detail that would be seen from the handle side

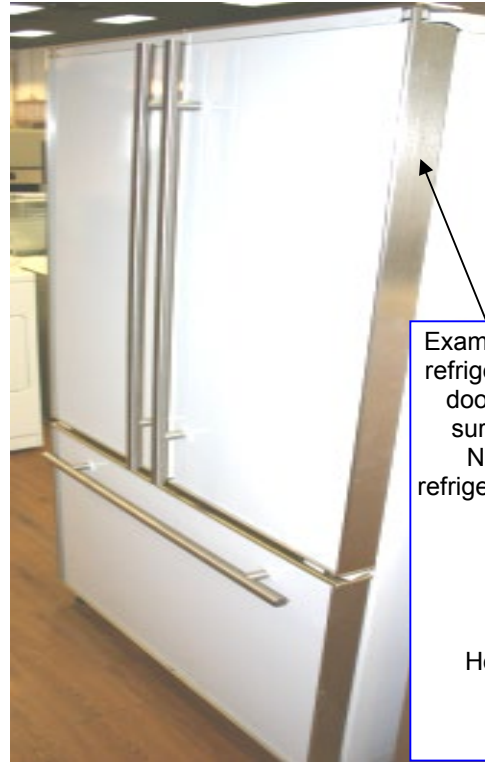

Example of Viking French Door refrigerator to accept appliance door panels. Metal Trim kit surrounds top, bottom and NON-handle side of the refrigerator doors and all 4 sides of the Freezer door.

Photo courtesy of  
Ron Barkman Sr.  
at  
Home Appliance Center  
Malvern, PA

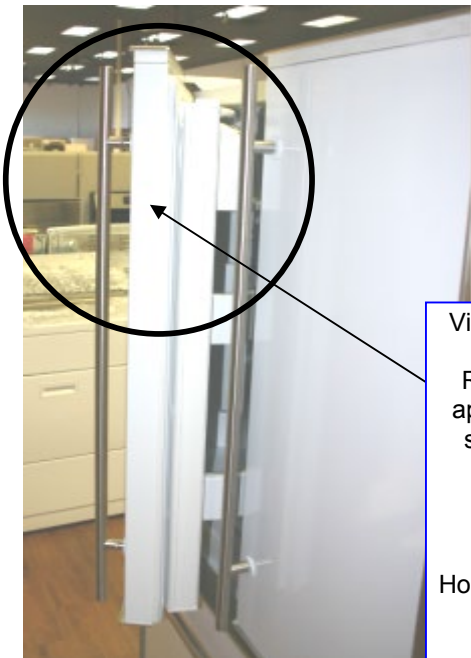

View of handle side of refrigerator door. Routing detail is not applied on the handle sides of the panels.

Photo courtesy of  
Ron Barkman Sr.  
at  
Home Appliance Center  
Malvern, PA

**Refrigerator - Side by Side with Dispenser Cutout**  
**"Overlay WITH Special Backer (3/4" + 3/8")"**

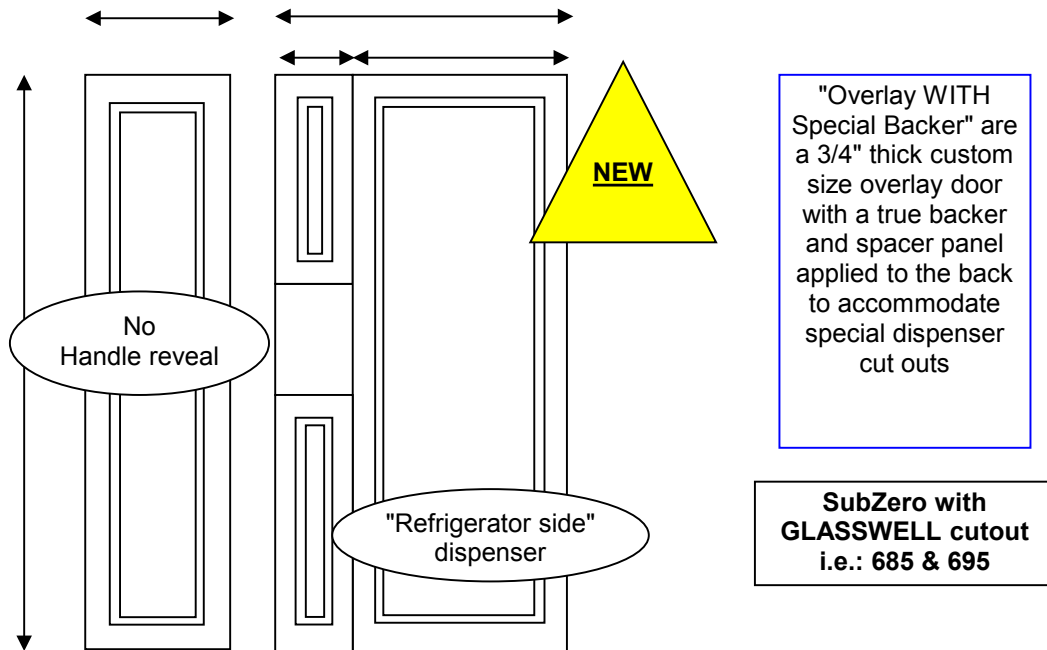

**SubZero with GLASSWELL cutout**  
 i.e.: 685 & 695

*Example - "Side by Side" with dispenser cut out on Refrigerator Door*

**Example of typical Overlay WITH Special Backer for Refrigerator with Dispenser cut out**

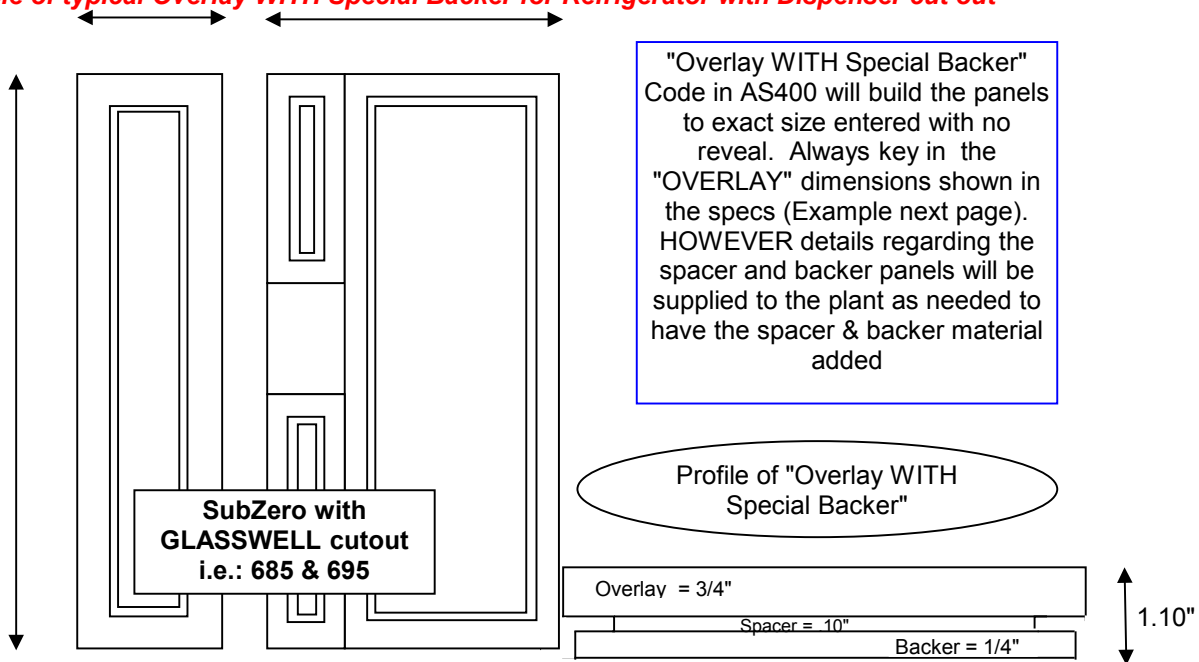

"Overlay WITH Special Backer" Code in AS400 will build the panels to exact size entered with no reveal. Always key in the "OVERLAY" dimensions shown in the specs (Example next page). HOWEVER details regarding the spacer and backer panels will be supplied to the plant as needed to have the spacer & backer material added

*Example - "Side by Side" with dispenser cut out on Refrigerator Door*

*See Illustration 12 & 13 next page*

## Refrigerator - Side by Side *with Dispenser Cutout* "Overlay WITH Special Backer (3/4" + 3/8")

Example of typical Overlay WITH Special Backer for Refrigerator with Dispenser cut out

**Model 695**

Refrigerator Overlay Panel	W 28" (711)	H 68" (1727)	Models 632 and 695	W
Refrigerator Spacer Panel	27 <sup>1</sup> / <sub>16</sub> " (687)	67 <sup>1</sup> / <sub>16</sub> " (1703)	Overlay Panel Width	46 <sup>7</sup> / <sub>16</sub> " (1180)
Refrigerator Backer Panel	27 <sup>11</sup> / <sub>16</sub> " (703)	67 <sup>11</sup> / <sub>16</sub> " (1719)	Spacer Panel Width	45 <sup>1</sup> / <sub>2</sub> " (1156)
Freezer Overlay Panel	18 <sup>1</sup> / <sub>4</sub> " (464)	68" (1727)	Backer Panel Width	46 <sup>1</sup> / <sub>8</sub> " (1172)
Freezer Spacer Panel	17 <sup>5</sup> / <sub>16</sub> " (440)	67 <sup>1</sup> / <sub>16</sub> " (1703)	<b>11" (279) Grille (standard)</b>	H
Freezer Backer Panel	17 <sup>15</sup> / <sub>16</sub> " (456)	67 <sup>11</sup> / <sub>16</sub> " (1719)	Overlay Panel Height	10 <sup>1</sup> / <sub>4</sub> " (260)
Glasswell Cut-out Dimensions	5 <sup>7</sup> / <sub>8</sub> " (150)	12 <sup>7</sup> / <sub>16</sub> " (315)	Spacer Panel Height	9 <sup>5</sup> / <sub>16</sub> " (237)
Glasswell Location (Overlay)	E) 1 <sup>11</sup> / <sub>16</sub> " (43)	F) 28 <sup>3</sup> / <sub>4</sub> " (730)	Backer Panel Height	9 <sup>15</sup> / <sub>16</sub> " (252)
Glasswell Location (Spacer)	E) 1 <sup>1</sup> / <sub>4</sub> " (31)	F) 28 <sup>1</sup> / <sub>4</sub> " (718)		
Glasswell Location (Backer)	E) 1 <sup>9</sup> / <sub>16</sub> " (29)	F) 28 <sup>9</sup> / <sub>16</sub> " (726)		

Glasswell cutouts will require that you order a 3/4" thick SLAB piece for installer to cut dispenser opening. This piece will be assembled with the other custom panels for the Refrigerator door.

Refer to these dimensions to calculate exact panel sizes

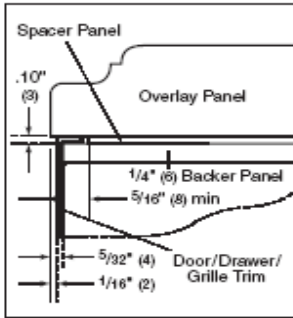

illus. 12

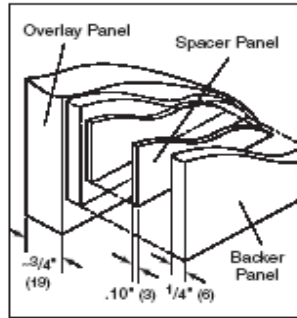

illus. 13

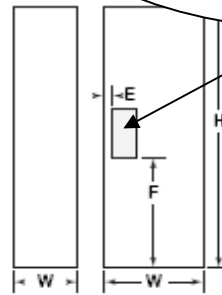

Models 685 and 695

See next page to calculate SLAB piece size as well as doors above, below and next to Glasswell

For grille panel size, use width dimensions listed for your model and height dimensions for grille option. **11" (279) grille is standard.**

Panel grille is available for all overlay units except Models 601R, 601RG and 601F.

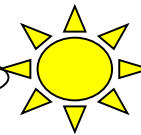

See note on next page to enter **Grill Panel**

## Refrigerator - Side by Side *with Dispenser Cutout* "Overlay WITH Special Backer (3/4" + 3/8")

**Calculating Glasswell SLAB panel size**

Glasswell Cut-out Dimensions	5 7/8" (150)	12 7/16" (315)
Glasswell Location (Overlay)	E) 1 11/16" (43)	F) 28 3/4" (730)
Glasswell Location (Spacer)	E) 1 1/4" (31)	F) 28 1/4" (718)
Glasswell Location (Backer)	E) 1 9/16" (39)	F) 28 9/16" (726)

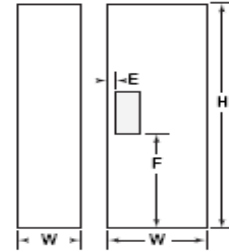

To calculate SLAB width take the "E" overlay dimension x 2

$$1 \frac{11}{16} \times 2 = \underline{3 \frac{3}{8}}$$

Plus the Cut out dimension width of 5 7/8

$$3 \frac{3}{8} + 5 \frac{7}{8} = \underline{9 \frac{1}{4}}$$

**9 1/4" is the width of the 3/4" SLAB**

"E" Dimension represents the space between the cut out and the edge of the panel. Doubling it allows for a border that matches on the left & right

To calculate SLAB height take the overlay Cut-Out dimension Plus "E" dimension x 2

$$12 \frac{7}{16} + 3 \frac{3}{8} = \underline{15 \frac{13}{16}}$$

**15 13/16" is the height of the 3/4" SLAB**

Cut-Out Dimension of 12 7/16" represents the height of the glasswell cut out. By adding the "E" dimension 2x's to the height, the top & bottom border will match the left & right

**Add item to panel order**

Use Panel-Appl\_\_ program to add this SLAB piece

Panel Group: **Side by Side**  
 Panel Reveal: **3/4" Finished Slab**  
 Appliance MFG: **SubZero**  
 Appliance Type: **Glasswell**  
 Model Number: **695**

Mark with "SUB" MFG code to tag as Subcomponent so plant will look for this piece to assemble with REF and FREEZER pieces

<b>Width</b>	<b>Height</b>	<b>Panel Type</b>	<b>Price</b>	<b>Need Drawing Y/N</b>	<b>MFG</b>
9 1/4	15 13/16	Leave Blank	320.00	Y	SUB

Make sure to indicate "Y" when it is an ASSEMBLY piece

## Refrigerator - Side by Side *with Dispenser Cutout* "Overlay WITH Special Backer (3/4" + 3/8")"

Calculating Doors panels above, below and next to Glasswell SLAB

Model 695	W	H
Refrigerator Overlay Panel	28" (711)	68" (1727)
Refrigerator Spacer Panel	27 <sup>1</sup> / <sub>16</sub> " (687)	67 <sup>1</sup> / <sub>16</sub> " (1703)
Refrigerator Backer Panel	27 <sup>11</sup> / <sub>16</sub> " (703)	67 <sup>11</sup> / <sub>16</sub> " (1719)
Freezer Overlay Panel	18 <sup>1</sup> / <sub>4</sub> " (464)	68" (1727)
Freezer Spacer Panel	17 <sup>5</sup> / <sub>16</sub> " (440)	67 <sup>1</sup> / <sub>16</sub> " (1703)
Freezer Backer Panel	17 <sup>15</sup> / <sub>16</sub> " (456)	67 <sup>11</sup> / <sub>16</sub> " (1719)
Glasswell Cut-out Dimensions	5 <sup>7</sup> / <sub>8</sub> " (150)	12 <sup>7</sup> / <sub>16</sub> " (315)
Glasswell Location (Overlay)	E) 1 <sup>11</sup> / <sub>16</sub> " (43)	F) 28 <sup>3</sup> / <sub>4</sub> " (730)
Glasswell Location (Spacer)	E) 1 <sup>1</sup> / <sub>4</sub> " (31)	F) 28 <sup>1</sup> / <sub>4</sub> " (718)
Glasswell Location (Backer)	E) 1 <sup>9</sup> / <sub>16</sub> " (39)	F) 28 <sup>9</sup> / <sub>16</sub> " (726)

To calculate the lower *Glasswell* door panel (marked 2)

- W The width will match the SLAB of 9 1/4"  
 H Take the total height of "F" 28 3/4" less 1 11/16" = 27 1/16"  
**Bottom REF panel is 9 1/4" x 27 1/16"**

To calculate the upper *Glasswell* door panel (marked 1)

- W The width will match the SLAB of 9 1/4"  
 H Take the total height of the REF door 68" less the SLAB 15 13/16"  
 less the lower door 27 1/16"  
**Upper REF panel is 9 1/4" x 25 1/8"**

To calculate the Full Length Door to the right of the Glasswell (marked 3)

- W The overall width of the panel is 28" less the 9 1/4" door above  
 the glasswell = 18 3/4"  
 H The height is exactly the same as the standard spec detail = 68"  
**Full Length REF door is 18 3/4" x 68"**

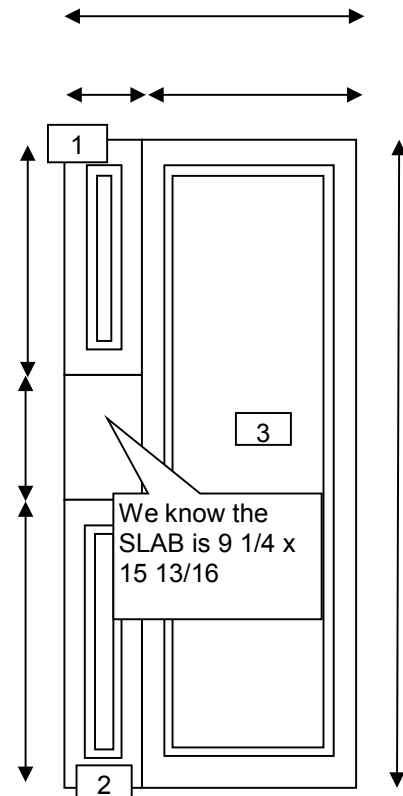

**FREEZER & GRILL panels are entered exactly as shown above using OVERLAY dimensions**

"Component" will

**Refrigerator - Side by Side with Dispenser Cutout**  
**"Overlay WITH Special Backer (3/4" + 3/8")"**

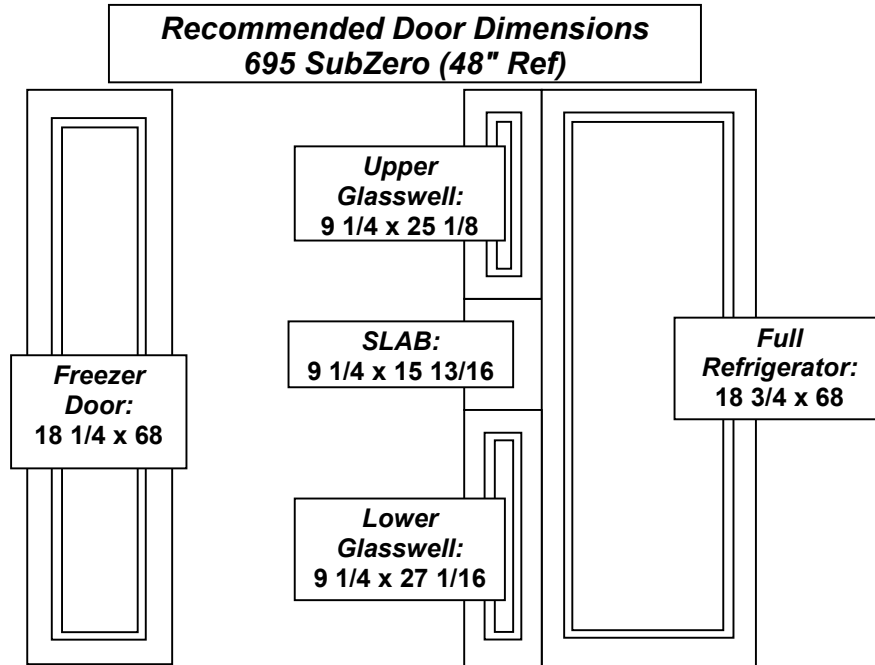

*Example - SubZero 695 "Side by Side" with dispenser cut out on Refrigerator Door*

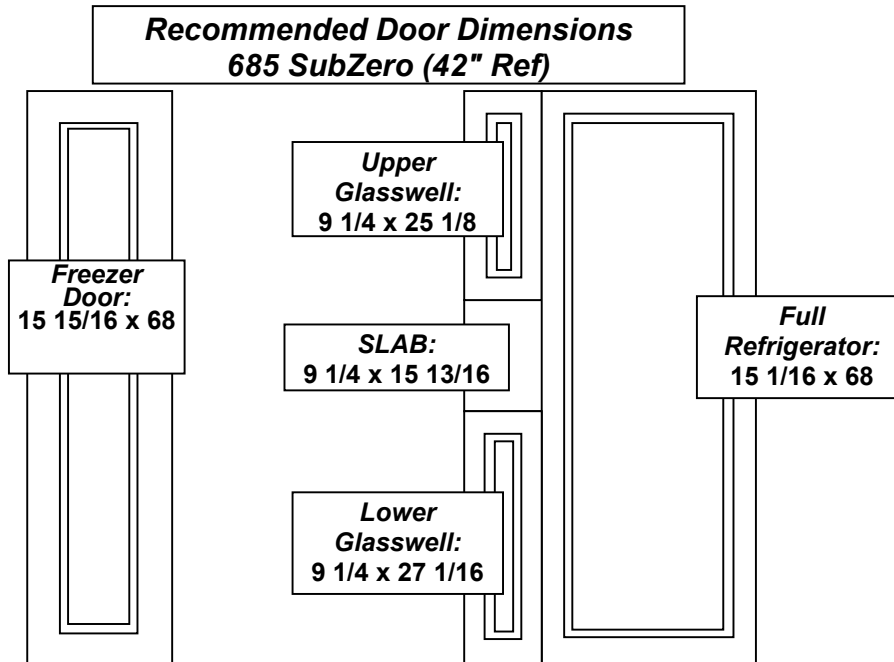

*Example - SubZero 685 "Side by Side" with dispenser cut out on Refrigerator Door*

## Refrigerator - Side by Side *with Dispenser Cutout* "Overlay WITH Special Backer (3/4" + 3/8")

Example of typical Overlay WITH Special Backer for Freezer with Dispenser cut out

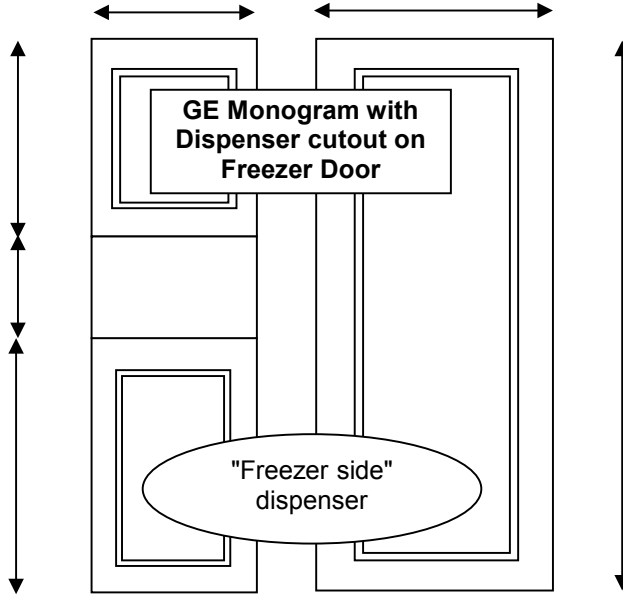

Use same technique as Refrigerator dispenser cut out to calculate dimensions of SLAB piece and door for above and below.

Always add approx. 2" to SLAB piece height to allow for about 1" reveal at the top and bottom of the cut out.  
...Make sure to deduct from the doors above and below.

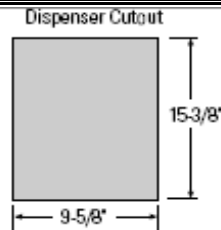
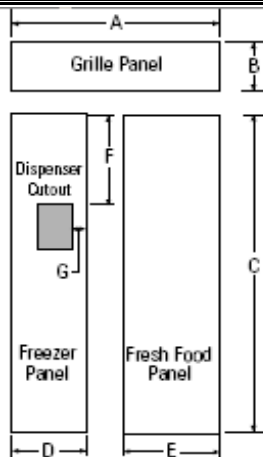

\*Cut the dispenser opening after the backer, spacer and overlay panels have been assembled.

36 & 42" GE Monograms will always require a slab piece for the dispenser cut out on the freezer door.

**36" Side-by-Side (in inches)**

	A	B	C	D	E	F	G
1/4" Backer Panel	33-7/8	9	68-3/8	14-9/16	18-9/16		
.10" Spacer Panel	33	8-3/8	67	13-1/4	17-1/4		
3/4" Overlay Panel	34-1/8	9-1/4	68-5/8	14-13/16	18-13/16	17-15/16	3-1/4

**42" Side-by-Side (in inches)**

	A	B	C	D	E	F	G
1/4" Backer Panel	39-7/8	9-1/2	68-3/8	14-9/16	24-9/16		
.10" Spacer Panel	39	8-5/8	67	13-1/4	23-1/4		
3/4" Overlay Panel	40-1/8	9-3/4	68-5/8	14-13/16	24-13/16	17-15/16	3-1/4

**48" Side-by-Side (in inches)**

	A	B	C	D	E	F	G
1/4" Backer Panel	45-7/8	9-1/2	68-3/8	18-9/16	26-9/16		
.10" Spacer Panel	45	8-5/8	67	17-1/4	25-1/4		
3/4" Overlay Panel	46-1/8	9-3/4	68-5/8	18-13/16	26-13/16	17-15/16	5-1/4

\*Dispenser Cutout Position

Follow same AS400 directions as Refrigerator side cut out.

48" GE Monogram refrigerators do not require a slab for the dispenser location. Typically the cut out will fit on to the center panel of the door.

**1/2" Reveal Panel  
"Framed" (1/4")**

**Generic Panel**

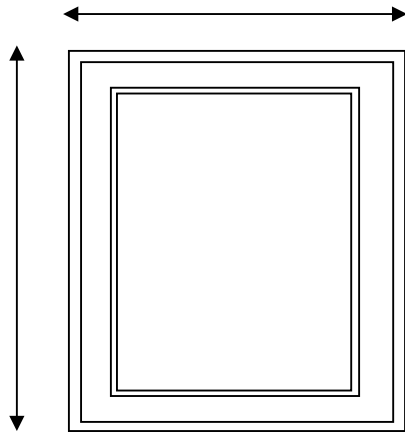

**1/2" Reveal Panel**

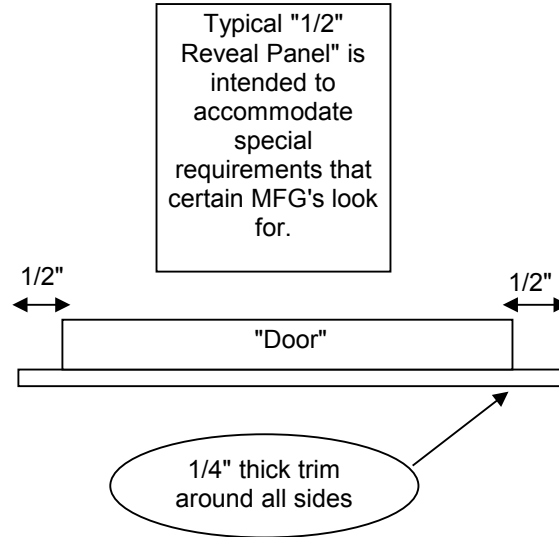

**Example of U-Line 1/2" Reveal Panel spec**



**ÉCHELON  
1/4" CUSTOM INSERT PANEL SIZES**

2115/CLR2160	27 11/16" H x 14 1/32" W
2175	27 11/16" H x 23 1/32" W
2175DWRR/CO2175DWR	12 15/32" H x 23 1/32" W

- Zero clearance with a flush/flat door panel.
- Door will accept a raised panel. Allow proper clearance, on hinge side when installing a raised panel. Amount of clearance will depend on raised panel thickness.
- The maximum panel thickness when inserted into the door reveal (channel) is 1/4" thick.
- For raised panels the depth of the reveal is 1/4" on both sides and bottom and 1/4" on top.
- Panel not to exceed 20 pounds.

This tells you it is "Framed"

Century will always use a 1/2" reveal on all panels of this type which will work as well.



## "Frame Only"

### "Overlay NO Routing" or "Overlay Special Routing" (3/4")

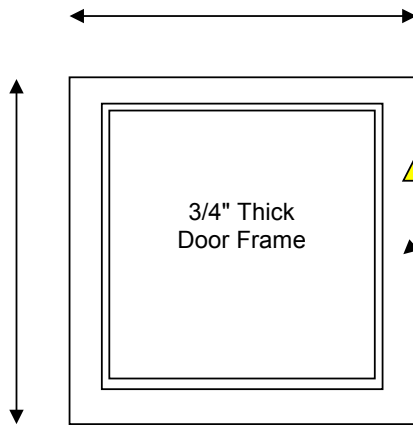

Typical SubZero Frame only

Typical "Frame Only". This is a 3/4" thick Frame made from *matching door rail* to use on glass front refrigerators, wine coolers, etc

We will no longer have to MFG these with a "generic" piece of slab material

Basically this piece looks similar to a glass door. However it is finished on front, outside and inside. The typical detail that holds the glass on a Century door is filled in to make it flat

See Exceptions on Page 3

### Common Frame Only routing details

- ▲ There appears to be 3 different possible details that may be needed for the "Frame Only" panel frame. This varies by manufacturer.
- ▲ 1. Calls for the back and side of the frame to be flat without any detail on it. **OR**
- ▲ 2. For routing typical of the SubZero style routing (see overlay with routing REF pages for details) **OR**
- ▲ 3. For routing on the back of the frame instead of the sides to allow it to lay flat against the glass frame on the appliance

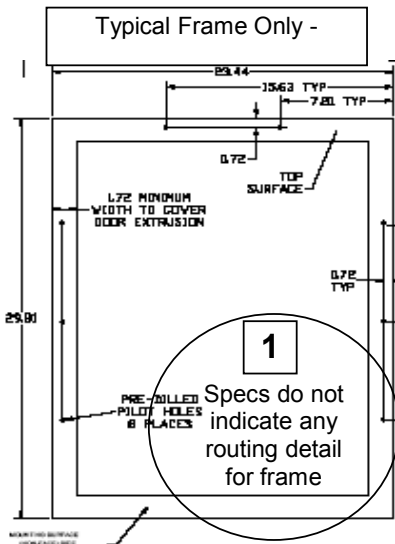

Typical Frame Only that does not require any routing detail

Use "Overlay No Routing" code on your order

Example From:

Marvel 24" Designer Door

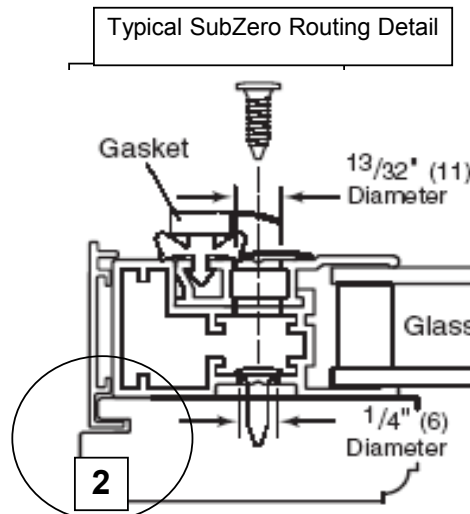

Typical Frame Only that requires routing detail on the sides of the frame

Use "Overlay Special Routing" code on your order

Example From:

SubZero 430

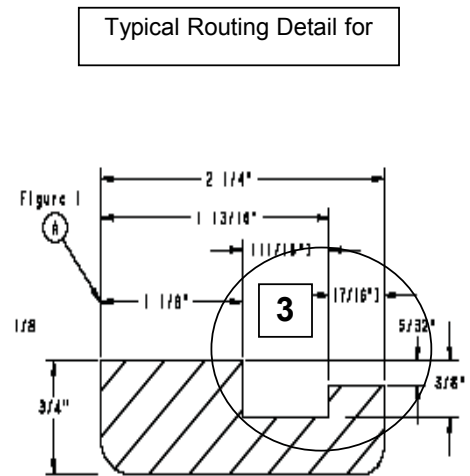

Typical Frame Only that requires routing detail only on the back of the frame

Use "Overlay Special Routing" code on your order

Example From:

U-Line 2175 & 2115

**"Frame Only"**

**"Overlay NO Routing" or "Overlay Special Routing" (3/4")**

"Frame Only"

"Overlay no Routing" or "Overlay Special Routing"

All "Frame Only" panels will be "filled" in as shown below, further routing detail "Overlay no Routing" or "Overlay Special Routing" will depend on the MFG specs that are provided. See details below.

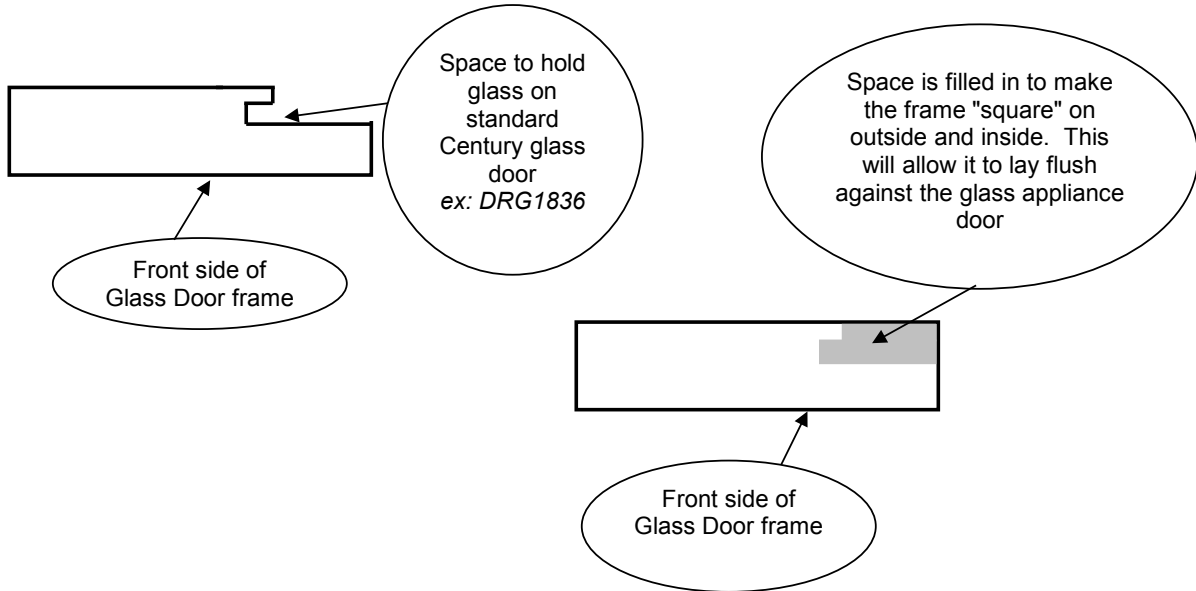

**Known exceptions for MFG of frame only panels**

Overlay Frame—Rear View

Create the custom overlay frame using the dimensions shown.

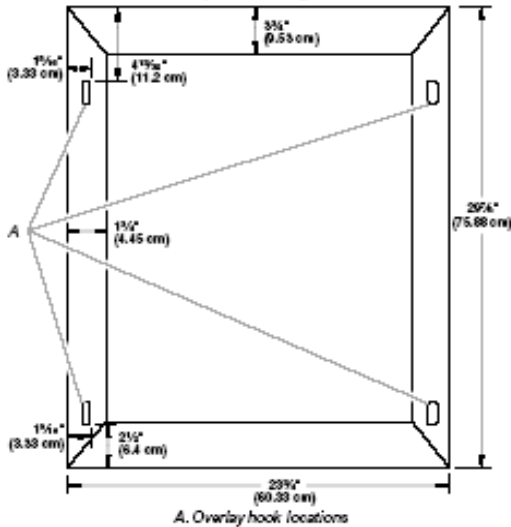

Several *Kitchen Aid* models require a wider Rail (3 3/4") than Stile (1 3/4"). Because you can't miter that frame correctly, Century will not be able to MFG frames with these requirements using a Door Rail. A Slab Filler piece will have to be used to make this type of frame

**"Trash Compactor / Compact Fridge / Wine Cooler"  
"Framed" (1/4")**

**Trash Compactor**

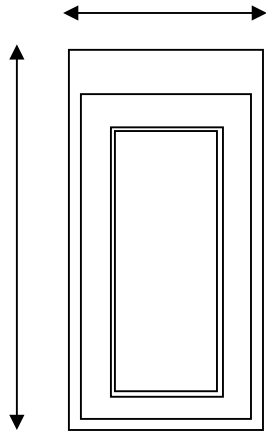

Typical "Framed" Trash Compactor panel. This is a 3/4" thick door with 1/4" thick trim around all sides. There is a 2 1/2" reveal at the Top and 1/2" on all other sides.

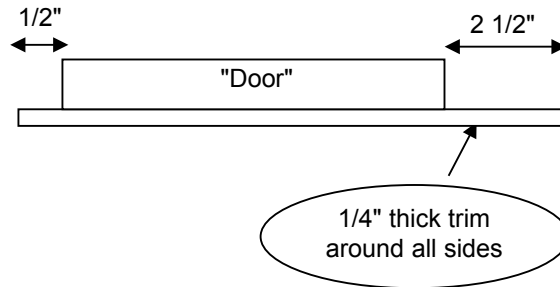

**Typical GE Profile Trash Compactor panel**

**Compact Refrigerator Handle on Top**

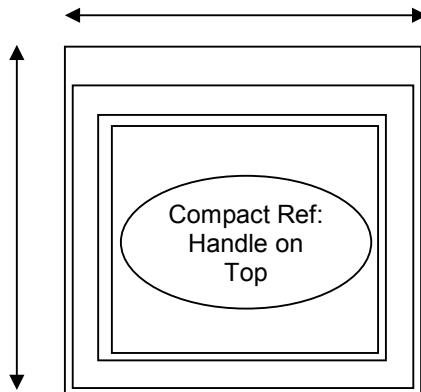

Typical "Framed" Compact Refrigerator Handle on Top panel. This is a 3/4" thick door with 1/4" thick trim around all sides. There is a 2 1/2" reveal at the Top and 1/2" on all other sides.

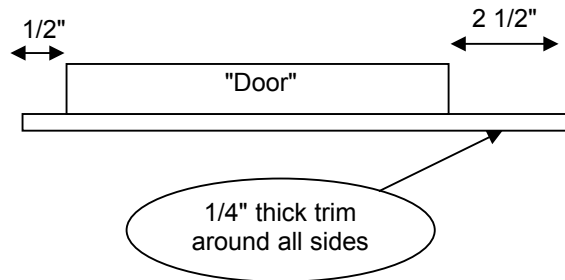

**Typical Compact Refrigerator - Handle on Top**

**Compact Refrigerator Handle on Side**

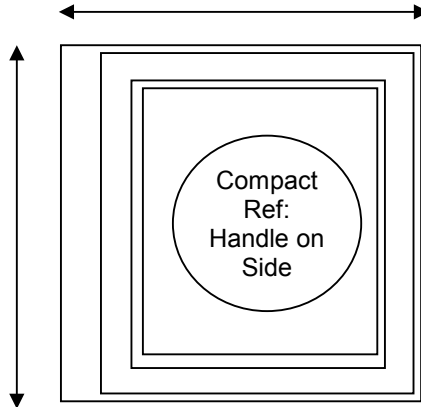

Typical "Framed" Compact Refrigerator Handle on Side panel. This is a 3/4" thick door with 1/4" thick trim around all sides. There is a 2 1/2" reveal at the Top and 1/2" on all other sides.

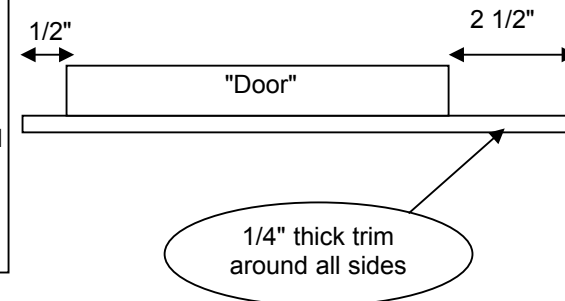

**Typical Compact Refrigerator - Handle on Side**

**"Trash Compactor / Compact Fridge / Wine Cooler"  
"Framed" (1/4")**

**Entering "Trash Compactor" or "Compact Ref..." in AS400**

Key in	QTY	MFG	STYLE	ITEM	DESCRIPTION
	1	CHS	HA	PANEL-APPL1	HAMPTON ANTIQUE

**Panel Group:** Trash Compactor  
**Panel Reveal:** Frame  
**Appliance MFG:** GE  
**Appliance Type:** Profile  
**Model Number:** 56985

Width	Height	Panel Type	Price	Need Drawing Y/N
15	30	<i>Leave Blank</i>	150.00	N

Follow same details for Compact Refrigerators,  
 however **ALWAYS CLARIFY WHERE THE  
 HANDLE LOCATION IS** so the reveal is located  
 in the correct place and it will operate properly

