

- ***Index***
- ***Moldings***
- ***Legs, Posts, & Plate Covers***
- ***Corbels & Brackets***
- ***Arched Valances & Mantels***
- ***Fireplace Mantels, Toekick, & Feet***
- ***Notes***

Moldings & Decorative Accessories

Page Location	Item Type	Nomenclature
191	Arched Radius Decorative Valance	ARDV
191	Arched Valance	AV
191	Arched Valance "Shaker"	AVS
188	Bottom Casement Molding	BCM8
187	Beaded Top/Bottom Molding	BTBM8
192	Base Tapered Foot	BTF
192	Bunn Foot	BUNN
190	Corbel "Grape", "Shaker", " or "Scroll"	CBL-G / CS / CR
192	Corner Foot	CFT
187	Crown Molding	CM8
187	Crown Molding "Angled"	CMA10
187	Crown Molding "Coved"	CMC10
187	Crown Molding "Egg and Dart"	CML10
187	Crown Molding "Small"	CMS8
187	Crown Molding "Large"	CMT10
187	Custom Shelf Kit	CSK
188	Furniture Toekick	FTK8
192	Foot "Tulip"	FTT
188	Inside Corner Molding	ICM8
190	L Bracket "Shaker" or "Transitional"	LBS / LBT
188	Light Valance Molding	LVM8
188	Light Valance Shaker Molding	LVSH8
191	Mantel	MANTEL
192	Fireplace Mantel	MANTEL-FP
191	Mantel "Shaker"	MS
188	Mirror Trim	MT8
188	Outside Corner Molding	OCM8
189	Farm Legs	PFL
188	Floating Shelves	FLSH
189	Pilaster Legs	PIL
190	Plates - Outlet Covers	PLATE
189	Pilaster Shaker Legs	PLS
189	Pilaster Transitional Legs	PLT
190	Roundell (3" or 6")	ROUNDELL
189	Reeded Post	RP6X6
192	Single Foot	SFT
188	Shoe Molding	SHOE8
187	Scribe	SS8
189	Tapered Leg	P43-5
191	Staright Valance	SV
189	Hour Glass Leg	P82-5
188	Top Casement Molding	TCM8
188	Toekick Cover	TKC8
192	Toekick Cover - Arched	TKCA
192	Toekick Cover - Ornamental	TKCO
188	Toekick End	TKE
188	Valance	V4M

Moldings

Crown Molding Angled

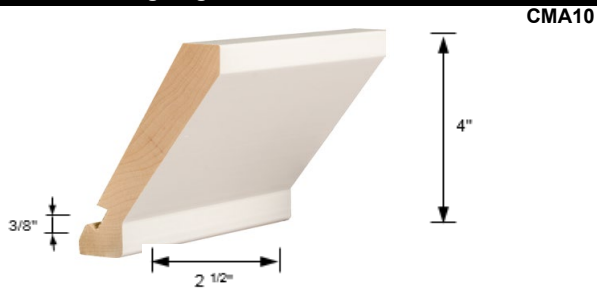

Sold in 10 Foot Lengths (4) Dovetail Installation

Crown Molding Coved

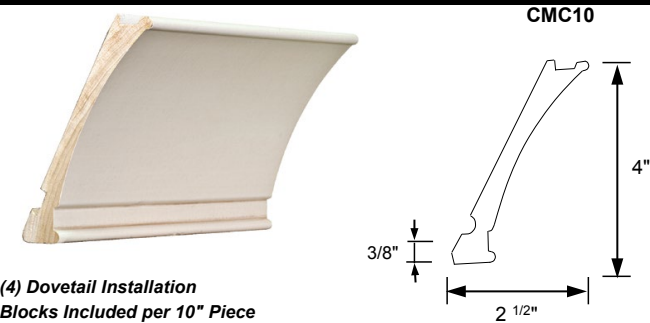

(4) Dovetail Installation
Blocks Included per 10" Piece
Sold in 10 Foot Lengths

Crown Molding Large

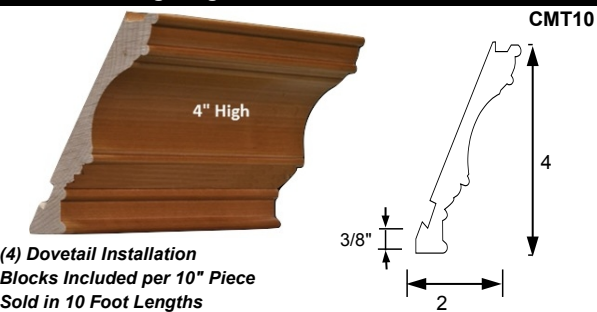

(4) Dovetail Installation
Blocks Included per 10" Piece
Sold in 10 Foot Lengths

Crown Molding Large-Egg & Dart

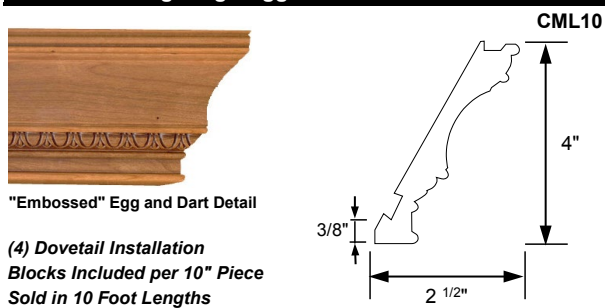

"Embossed" Egg and Dart Detail
(4) Dovetail Installation
Blocks Included per 10" Piece
Sold in 10 Foot Lengths

Crown Molding

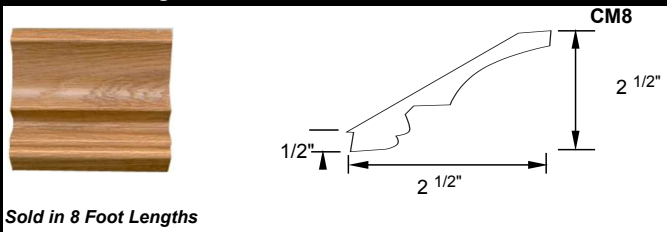

Sold in 8 Foot Lengths

Crown Molding "Small"

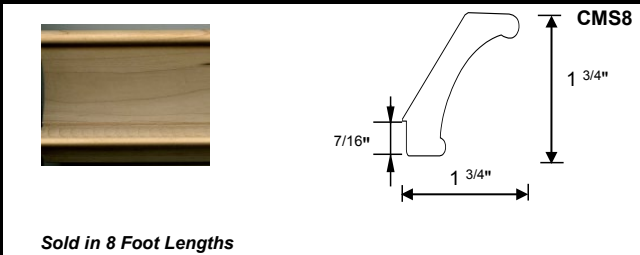

Sold in 8 Foot Lengths

Available with GHS series in the following finishes ONLY:

Chestnut Maple	Espresso Maple	Eggshell	White
Auburn Maple	Sand Maple	Gray	Willow

Scribe Molding

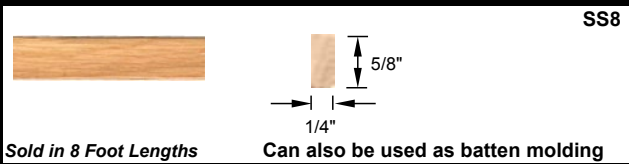

Sold in 8 Foot Lengths

Can also be used as batten molding



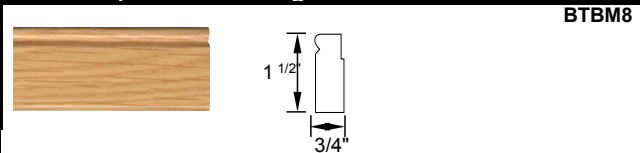

Beaded Top Bottom Molding

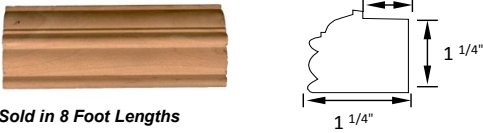
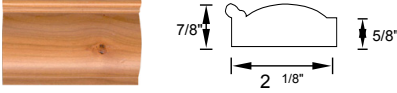

Sold in 8 Foot Lengths

Moldings & Decorative Accessories : Moldings

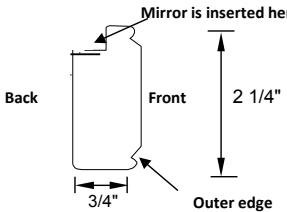
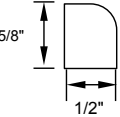
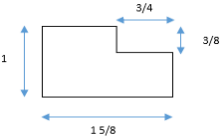
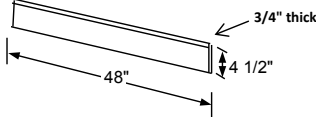
Moldings

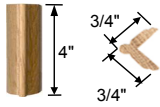
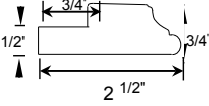
<p>Top Casement Molding</p>  <p><i>Sold in 8 Foot Lengths</i></p> <p>Used with Wainscoting</p> <p>TCM8</p>	<p>Bottom Casement Molding</p>  <p><i>Sold in 8 Foot Lengths</i></p> <p>Used with Wainscoting</p> <p>BCM8</p>								
<p>Inside Corner Molding</p>  <p><i>Sold in 8 Foot Lengths</i></p> <p>ICM8</p>	<p>Outside Corner Molding</p>  <p><i>Sold in 8 Foot Lengths</i></p> <p>OCM8</p>								
<p>Mirror Trim Molding</p>  <p><i>Sold in 8 Foot Lengths</i></p> <p>*Available in all Cherry, Maple, and Painted finishes.</p> <p>MT8</p>	<p>Shoe Molding</p>  <p><i>Sold in 8 Foot Lengths</i></p> <p>Available with GHS series in the following finishes ONLY:</p> <table border="1" data-bbox="816 877 1463 919"> <tbody> <tr> <td>Chestnut Maple</td> <td>Espresso Maple</td> <td>Eggshell</td> <td>White</td> </tr> <tr> <td>Auburn Maple</td> <td>Sand Maple</td> <td>Gray</td> <td>Willow</td> </tr> </tbody> </table> <p>SHOE8</p>	Chestnut Maple	Espresso Maple	Eggshell	White	Auburn Maple	Sand Maple	Gray	Willow
Chestnut Maple	Espresso Maple	Eggshell	White						
Auburn Maple	Sand Maple	Gray	Willow						
<p>Light Valance Shaker Molding</p>  <p><i>Sold in 8 Foot Lengths</i></p> <p>LVSH8</p>	<p>Valance</p>  <p>V4M</p>								
<p>Toe Kick Covers</p>  <p><i>Sold in 8 Foot Lengths</i></p> <p>TKC8</p>	<p>Furniture Toe Kick</p>  <p><i>Sold in 8 Foot Lengths</i></p> <p>FTK8</p>								
<p>Toe Kick End</p>  <p>TKE</p>	<p>Light Valance Molding</p>  <p><i>Sold in 8 Foot Lengths</i></p> <p>LVM8</p>								
<p>Custom Shelf Kit</p> <p>CSK96</p>	<p>Wood Veneer</p> <p>96" Long Wood Veneer Shelf</p>	<p>Length x Width x Thickness</p> <p>96 x 13 x 3/4</p>							

Moldings & Decorative Accessories : Legs, Posts & Plate Covers

Decorative Accessories- Legs/Posts

Pilaster Farm Leg

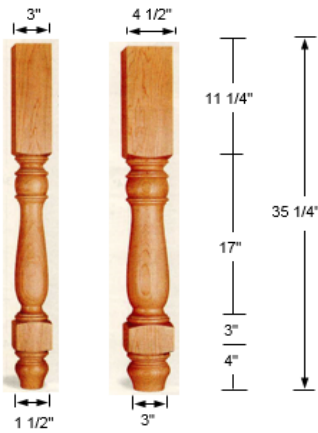

PFL030335
PFL040435

****Trimmable**

Reeded Post

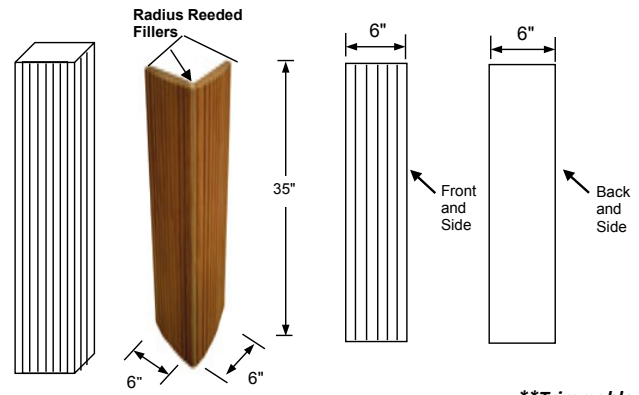

RP6X6

****Trimmable**

Pilaster Leg "Shaker"

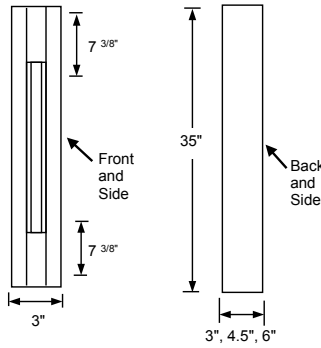

(3") PLS030335
(6") PLS060635
(4.5") PLS04504535

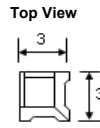

All Sides Finished

****Trimmable**

Pilaster Leg "Transitional"

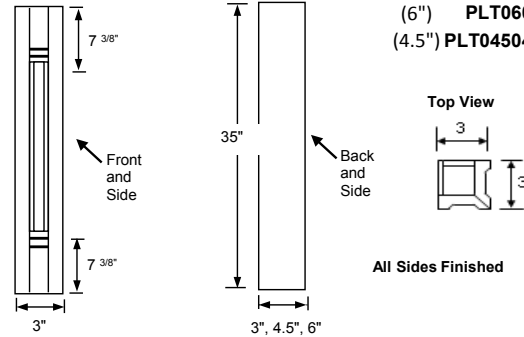

(3") PLT030335
(6") PLT060635
(4.5") PLT04504535

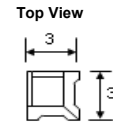

All Sides Finished

****Trimmable**

Tapered Leg



P43-5

****Trimmable**

Hour Glass Leg



P82-5

****Trimmable**

Pilasters

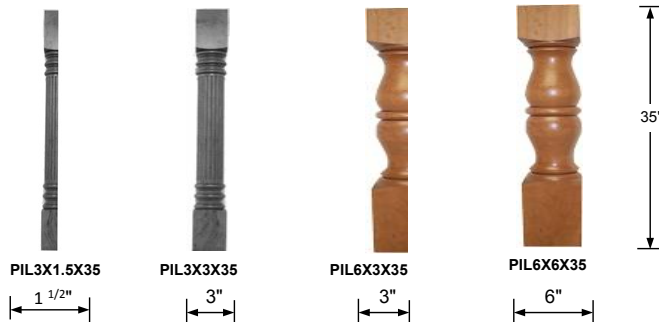

PIL3X1.5X35
PIL3X3X35
PIL6X3X35
PIL6X6X35

****Trimmable**

Moldings & Decorative Accessories : Appliques, Corbels & Brackets

Decorative Accessories- Miscellaneous

Plate Covers

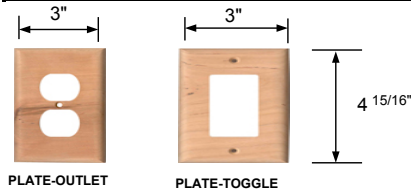

PLATE-OUTLET
PLATE-TOGGLE

Decorative Accessories- Corbels, and Brackets

Roundell



Roundell

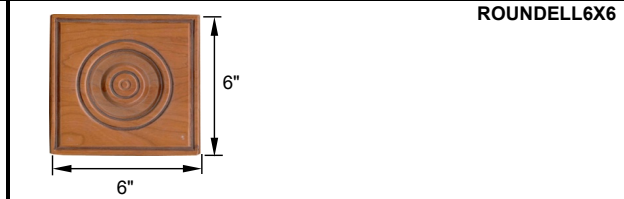

Corbel-Shaker

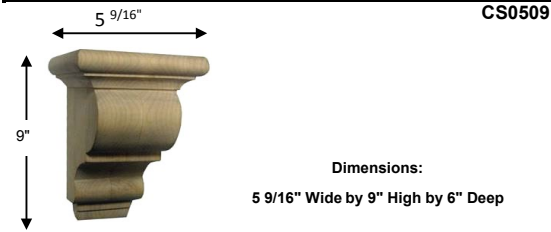

Corbel-Scroll

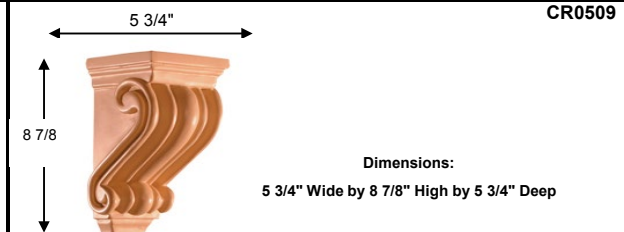

"L" Bracket - "Shaker"

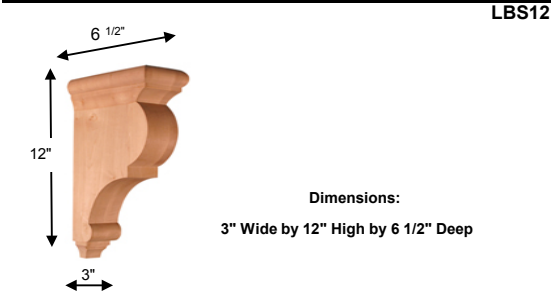

"L" Bracket - "Shaker"

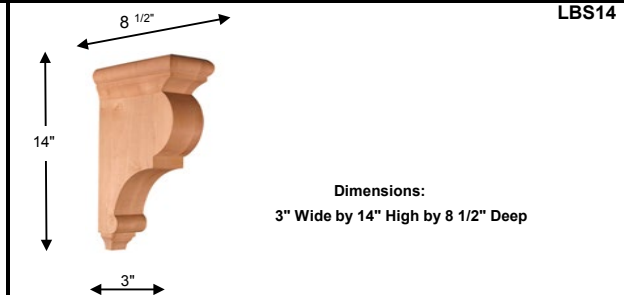

"L" Bracket- "Transitional"

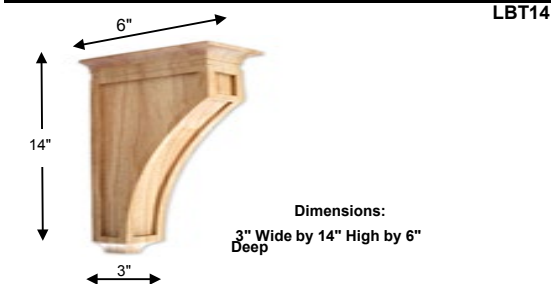

Corbel-Grape

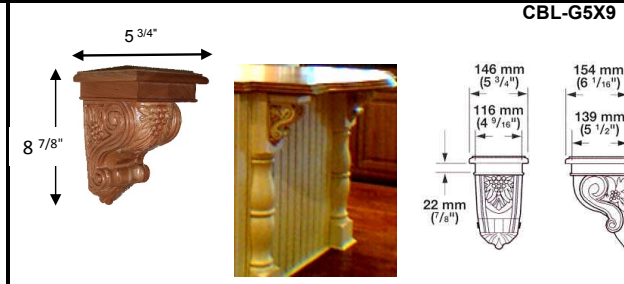

Decorative Accessories - Arched Valances and Mantels

Arched Valance

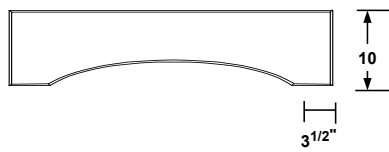

***Valance Cannot Be Trimmed

Center Height	
AV3010	7"
AV3610 - AV7210	5"

AV3010
AV3610
AV4210
AV4810
AV5410
AV6010
AV6610
AV7210

Arched Valance- "Shaker" 8" TALL



***Valance is Trimmable

Center Height	
AVS4808 - AVS6608	7"

AVS4808
AVS5408
AVS6008
AVS6608

* Note: This valance to be used with PCCS034818 L/R and PCCS034824 L/R

Arched Valance- "Shaker"

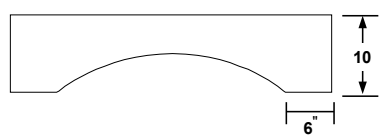

***Valance is Trimmable

Center Height	
AVS3010	7"
AVS3610 - AVS7210	5"

AVS3010
AVS3610
AVS4210
AVS4810
AVS5410
AVS6010
AVS6610
AVS7210

Arched Radius Decorative Valance

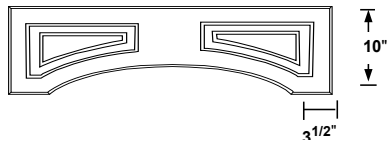

***Valance Cannot Be Trimmed

Center Height	
ARDV3010	7"
ARDV3610	7"
ARDV4210 - ARDV7210	7 7/16"

ARDV3010
ARDV3610
ARDV4210
ARDV4810
ARDV5410
ARDV6010
ARDV6610
ARDV7210

*Must be installed between cabinets, edges must be concealed

*Note: This valance cannot be used with a Mantel

Straight Valance

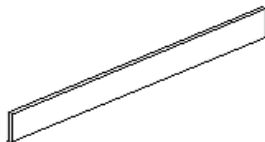

SV3608
SV4808
SV6008
SV7208

Mantels

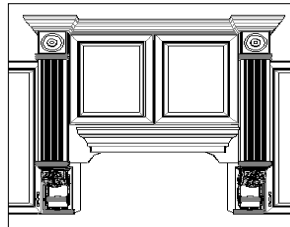
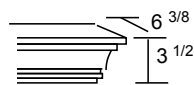

Mantels should only be used with an Arched Valance "AV"

MANTEL27
MANTEL30
MANTEL33
MANTEL39
MANTEL45
MANTEL51
MANTEL57
MANTEL60
MANTEL69

Mantels- "Shaker"



Shaker Mantels should be used with an Arch Valance Shaker "AVS".

MS29
MS35
MS41
MS47
MS53
MS59
MS65
MS71

Moldings & Decorative Accessories : Fireplace Mantels, Toekick & Feet

Decorative Accessories - Fireplace Mantels, Toekick, and Feet

Fireplace Mantels

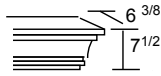
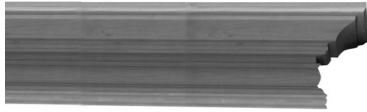

MANTEL36-FP
MANTEL42-FP
MANTEL48-FP
MANTEL60-FP

Toe Kick Covers - Ornamental

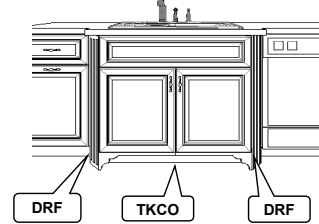

TKCO shown with Diagonal Reed Filler

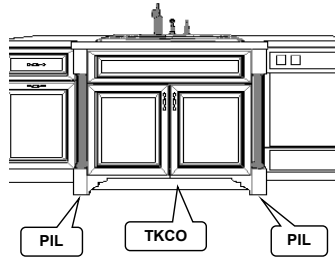

TKCO shown with Pilasters

In order to achieve this effect, you need to order a DRF3/96 and cut it down to two 34 1/2" high DRFs.

TKCO12
TKCO15
TKCO18
TKCO21
TKCO24
TKCO27
TKCO30
TKCO33
TKCO36
TKCO42
TKCO48
TKCO54
TKCO60
TKCO66
TKCO72

Toe Kick Covers - Arched

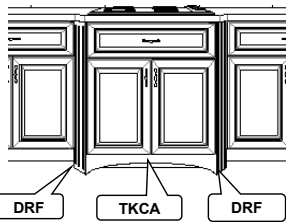

TKCA shown with Diagonal Reed Filler

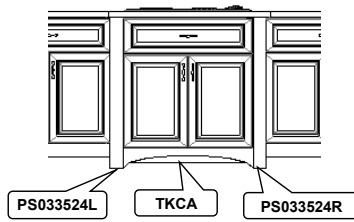

TKCA shown with Shaker Pilasters

In order to achieve this effect, you need to order a DRF3/96 and cut it down to two 34 1/2" high DRFs.

TKCA12
TKCA15
TKCA18
TKCA21
TKCA24
TKCA27
TKCA30
TKCA33
TKCA36
TKCA42
TKCA48
TKCA54
TKCA60
TKCA66
TKCA72

Tulip Foot

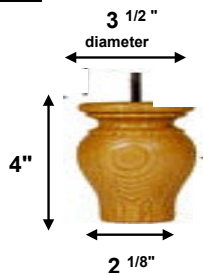

Installation conflicts with toe kick!

Bunn Foot

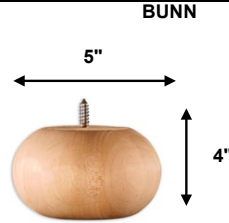

Installation conflicts with toe kick!

Shaker Bun Foot

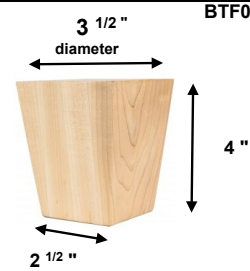

Single Foot Left or Right Hand

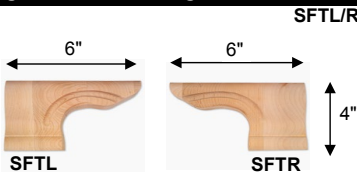

Corner Foot



There is a block over the side that sits below the cabinet door, so you must order either a Left Hand or a Right Hand Corner Foot

