

- *Index*
- *Fillers*
- *End Panels*
- *End Fillers*
- *Decorative End Panels*

Fillers & Panels

Page located	Cabinet Type	Nomenclature
124	Base End Panel	EPB
120	Corner Filler Base (Flat or Overlay)	CFB3
120	Corner Filler Wall (Flat or Overlay)	CFW3
128	Decorative End Panels	EPDR
122	Diagonal Filler Inside Corner "Shaker"	DFICS
122	Diagonal Filler Inside Corner "Transitional"	DFICT
126	Diagonal Reeded End Filler	DREF
122	Diagonal Reeded Filler	DRF
122	Diagonal Reeded Filler Inside Corner	DRFIC
119	End Corner Filler	ECF
125	End Filler Flat	EFF
126	End Filler Flat Narrow	EFFN
125	End Filler Overlay	EFO
125	End Filler Reeded	EFR
124	End Panel	EP
123	Filler "Pilaster"	FP
123	Filler "Shaker"	FS
123	Filler "Transitional"	FT
119	Filler (Flat or Overlay)	F
121	Filler 45°	F45
119	Filler Reeded	FR
124	Laminate Sheets	LAMINATE
124	Panel Backer	PB
124	Panel Backer "Beaded"	PBB
120	Reeded Corner Filler Base	RCFB
119	Starter Filler	F58
124	Wall End Panel	EPW

Fillers & Panels : Fillers

Fillers

	Length	Width	Thickness	
--	--------	-------	-----------	--

Fillers (GHS and CHS)

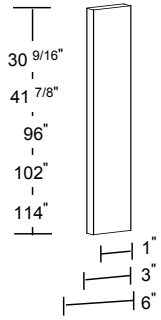

F1	30 ⁹ / ₁₆ \"	1	3/4
F3	30 ⁹ / ₁₆ \"	3	3/4
F6	30 ⁹ / ₁₆ \"	6	3/4
F3/42	41 ⁷ / ₈ \"	3	3/4
F6/42	41 ⁷ / ₈ \"	6	3/4
F3/96*	96	3	3/4
F6/96*	96	6	3/4
F3/102	102	3	3/4
F3/114	114	3	3/4
F6/114	114	6	3/4

If you order GHS or CHS you will receive a flat filler

*Edges are finished

Fillers w/Overlay (Vassar House Series only)

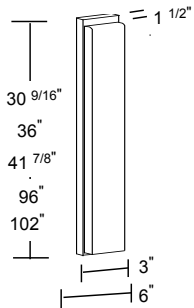

F1	30 ⁹ / ₁₆ \"	1	1 1/2
F3	30 ⁹ / ₁₆ \"	3	1 1/2
F6	30 ⁹ / ₁₆ \"	6	1 1/2
F3/36	36	3	1 1/2
F6/36	36	6	1 1/2
F3/42	41 ⁷ / ₈ \"	3	1 1/2
F6/42	41 ⁷ / ₈ \"	6	1 1/2
F3/96	96	3	1 1/2
F3/102	102	3	1 1/2

Filler with Reeded Overlay

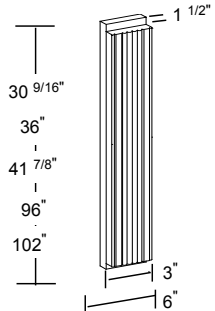

FR3/30	30 ⁹ / ₁₆ \"	3	1 1/2
FR6/30	30 ⁹ / ₁₆ \"	6	1 1/2
FR3/36	36	3	1 1/2
FR6/36	36	6	1 1/2
FR3/42	41 ⁷ / ₈ \"	3	1 1/2
FR6/42	41 ⁷ / ₈ \"	6	1 1/2
FR3/96	96	3	1 1/2
FR6/96	96	6	1 1/2
FR3/102	102	6	1 1/2

Starter Fillers

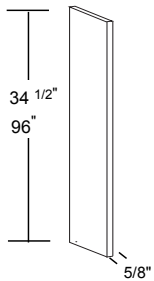

F5834	34 ¹ / ₂ \"	4	5/8
F5896	96	4	5/8

Starter filler used to create space between the cabinet and the wall to allow doors and drawers to open properly

Edge - Banded side is the 5/8" thick finished side

End Corner Fillers

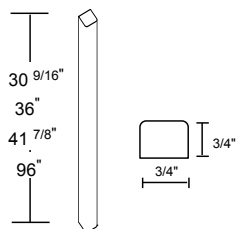

ECF30	30 ⁹ / ₁₆ \"	3/4	3/4
ECF36	36	3/4	3/4
ECF42	41 ⁷ / ₈ \"	3/4	3/4
ECF96	96	3/4	3/4

Fillers & Panels : Fillers

Fillers

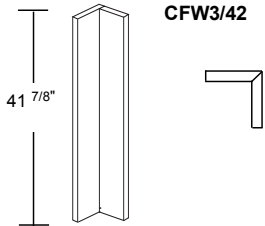
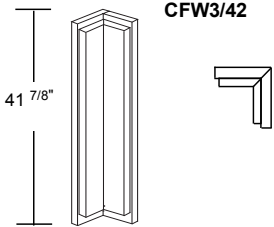
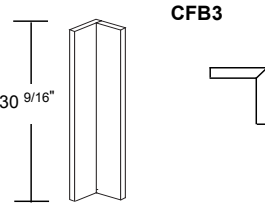
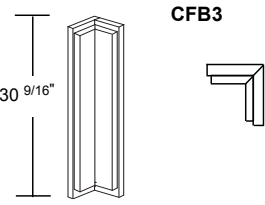
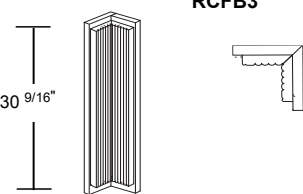
		Length	Width1	Width2	
Corner Filler Wall (GHS and CHS)					
	CFW3/42	41 ^{7/8}	3	3	Corner Filler Base 3x3 Provides 3" Clearance in each direction
Corner Filler Wall Overlay (VHS)					
	CFW3/42	41 ^{7/8}	3	3	Corner Filler Base 3x3 with overlay Provides 3" Clearance in each direction
Corner Filler Base (GHS and CHS)					
	CFB3	30 ^{9/16}	3	3	Corner Filler Base 3x3 Provides 3" Clearance in each direction
Corner Filler Base w/Overlay (Vassar House Series only)					
	CFB3	30 ^{9/16}	3	3	Corner Filler Base 3x3 with overlay Provides 3" Clearance in each direction
Reeded Corner Filler Base					
	RCFB3	30 ^{9/16}	3	3	Reed Corner Filler Base 3x3 Provides 3" Clearance in each direction

Fillers & Panels : Fillers

Fillers

Angle Fillers	Length	Width 1	Width 2
---------------	--------	---------	---------

F45 30 3/4 5/8

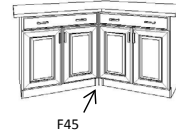
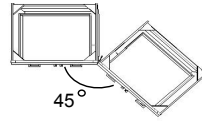
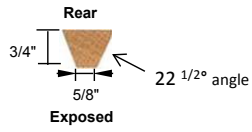
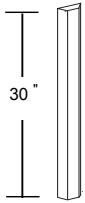

Fillers

Diagonal Reeded Filler

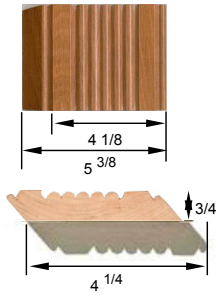

	Length	Width	Thickness
DRF3/30	30 1/2	4 1/8	1 1/2
DRF3/96	96	4 1/8	1 1/2

DRF3/30:
Backer piece is 30 1/2" high
Reed Filler is 29 1/2" high

DRF3/96:
Backer piece is 96" high
Reeded Filler is 95 1/2" high

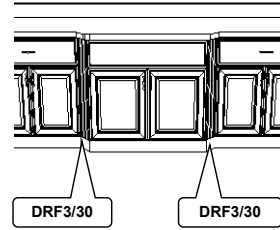

Diagonal Filler Inside Corner

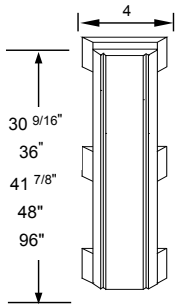

	Length	Width	Thickness
DRFIC3X3/30	30 9/16	4 1/8	1 1/2
DRFIC3X3/36	36	4 1/8	1 1/2
DRFIC3X3/42	41 7/8	4 1/8	1 1/2
DRFIC3X3/48	48	4 1/8	1 1/2
DRFIC3X3/96	96	4 1/8	1 1/2

Top View
3/4" Backer
2 1/4" width
3/4" height

Diagonal Filler Inside Corner "Shaker"

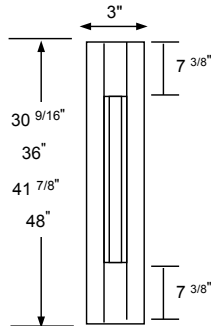

	Length	Width	Thickness
DFICS0330	30 9/16	4 1/8	1 1/2
DFICS0336	36	4 1/8	1 1/2
DFICS0342	41 7/8	4 1/8	1 1/2
DFICS0348	48	4 1/8	1 1/2

Top View
3/4" Backer
2 7/8" width
7/8" height

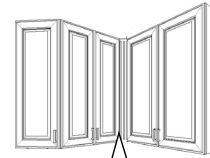

Diagonal Inside Corner Filler Shaker

Crown molding should overlay the filler

Diagonal Filler Inside Corner "Transitional"

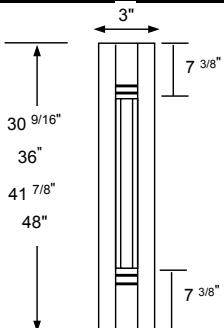

	Length	Width	Thickness
DFICT0330	30 9/16	4 1/8	1 1/2
DFICT0336	36	4 1/8	1 1/2
DFICT0342	41 7/8	4 1/8	1 1/2
DFICT0348	48	4 1/8	1 1/2

Top View
3/4" Backer
2 7/8" width
7/8" height

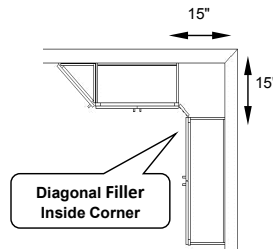

Diagonal Filler Inside Corner

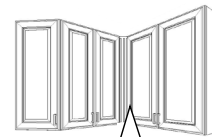

Diagonal Inside Corner Filler Transitional

Crown molding should overlay the filler

Fillers

Filler Pilaster

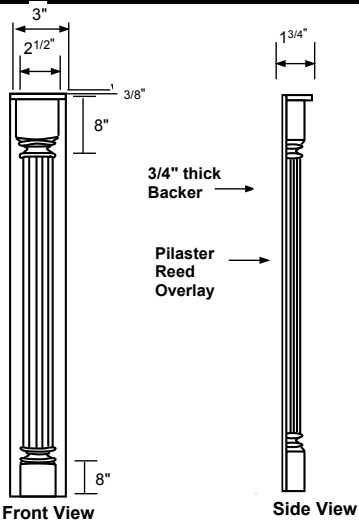

	Length	Width	Thickness
FP0330	30 ⁹ / ₁₆	3	1 ³ / ₄
FP0335	35	3	1 ³ / ₄
FP0336	36	3	1 ³ / ₄
FP0342	42	3	1 ³ / ₄
FP0348	48	3	1 ³ / ₄
FP0354	54	3	1 ³ / ₄
FP0360	60	3	1 ³ / ₄
FP0384	84	3	1 ³ / ₄
FP0390	90	3	1 ³ / ₄
FP0396	96	3	1 ³ / ₄
FP03102	102	3	1 ³ / ₄

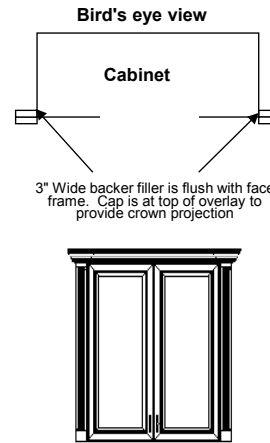

Filler "SHAKER"

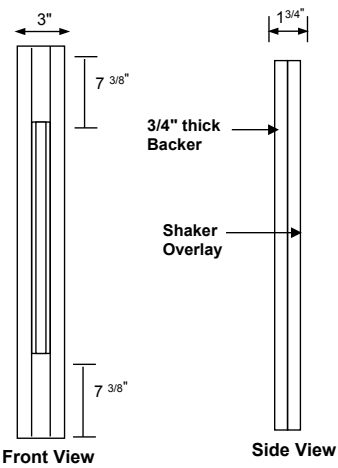

FS0330	30 ⁹ / ₁₆	3	1 ³ / ₄
FS0335	35	3	1 ³ / ₄
FS0336	36	3	1 ³ / ₄
FS0342	41 ⁷ / ₈	3	1 ³ / ₄
FS0348	48	3	1 ³ / ₄
FS0354	54	3	1 ³ / ₄
FS0360	60	3	1 ³ / ₄
FS0384	84	3	1 ³ / ₄
FS0390	90	3	1 ³ / ₄
FS0396	96	3	1 ³ / ₄
FS03102	102	3	1 ³ / ₄

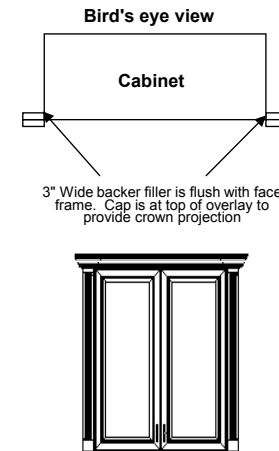

Filler "TRANSITIONAL"

*Intended for use with VHS Newport door Style

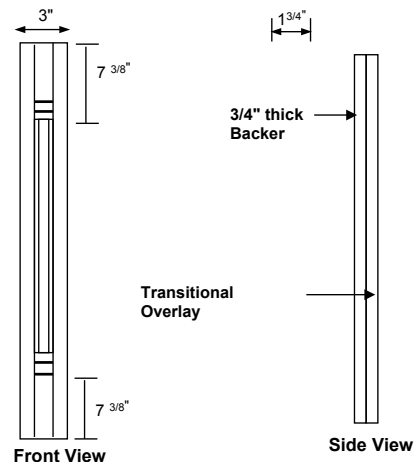

FT0330	30 ⁹ / ₁₆	3	1 ³ / ₄
FT0335	35	3	1 ³ / ₄
FT0336	36	3	1 ³ / ₄
FT0342	41 ⁷ / ₈	3	1 ³ / ₄
FT0348	48	3	1 ³ / ₄
FT0354	54	3	1 ³ / ₄
FT0360	60	3	1 ³ / ₄
FT0384	84	3	1 ³ / ₄
FT0390	90	3	1 ³ / ₄
FT0396	96	3	1 ³ / ₄
FT03102	102	3	1 ³ / ₄

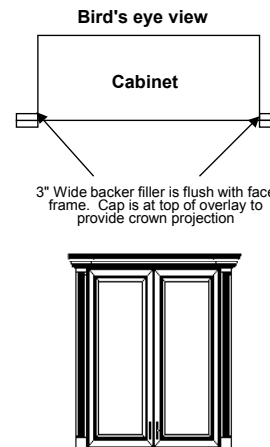

Fillers & Panels : End Panels

End Panels

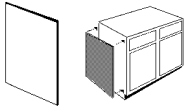
		Depth	Height	Thickness	
End Panels (Skins)					
	EPB34	23 1/4	30 9/16	1/32	<i>EPB and EPW fit behind the face frame of unfinished cabinet side</i>
	EPW30	11 1/4	30 9/16	1/32	<i>Black Mocha and Willow finishes are 1/32" thick painted veneer.</i>
	EPW42	11 1/4	41 7/8	1/32	<i>Auburn Black Distressed, Chestnut Distressed and Walnut Black Distressed finishes are 1/32" Stained Veneer</i> <i>All other finishes are 1/32" thick High Pressure Laminate (HPL)</i>

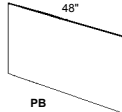
		Depth	Height	Thickness	
Panel Backer					
	PB34	48	34 1/2	1/4	<i>Black Mocha and Willow finishes are 1/4" thick painted MDF</i>
	PB42	48	42	1/4	<i>Auburn Black Distressed, Chestnut Distressed, Walnut Black Distressed are 1/4" thick Stained Veneer Panel</i> <i>All other finishes are 1/4" thick melamine</i>

		Depth	Height	Thickness	
Panel Backer Beaded					
	PBB34	48	34 1/2	1/4	<i>Wood Finishes are 1/4" thick Veneer Stained</i>
	PBB42	48	42	1/4	<i>Painted Finishes are 1/4" thick Medium Density Fiberboard (MDF)</i>

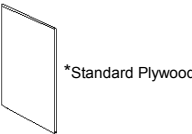
		Depth	Height	Thickness	
End Panels 5/8" Thick					
	EP34	24	34 1/2	5/8	Edge Banded on both long edges Finished on all sides
	EP96	24	96	5/8	
	EP102*	24	102	5/8	
	EP114*	24	114	5/8	
	EP3096	30	96	5/8	
EP30102	30	102	5/8		

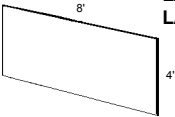
		Depth	Height	Thickness	
Laminate Sheets					
	LAMINATE4X4	48	48	1/32	<i>Cut to Size In Field</i>
	LAMINATE4X8	96	48	1/32	<i>Black Mocha and Willow finishes are 1/32" thick painted veneer.</i> <i>Auburn Black Distressed, Chestnut Distressed, Walnut Black Distressed finishes are 1/32" Stained Veneer.</i> <i>All other finishes are 1/32" thick High Pressure Laminate (HPL).</i>

Fillers & Panels : End Fillers

End Fillers

EFF End Filler Flat

	Depth	Height	Width
EFF34	24	34 1/2	3
EFF96	24	96	3
Standard Plywood EFF102	24	102	3
EFF114*	24	114	3
EFF3096	30	96	3

The Flat filler is attached directly to the end panel

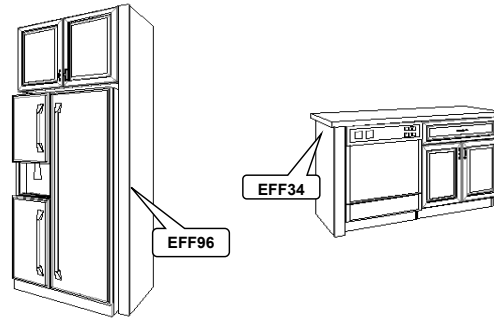
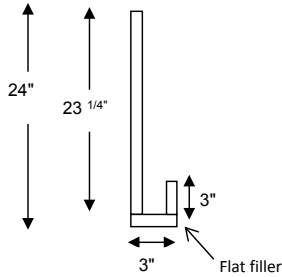

EFR End Filler Reeded

EFR34	24	34 1/2	3
EFR96	24	96	3
Standard Plywood EFR102	24	102	3
EFR3096	30	96	3

The Reeded filler is attached directly to the end panel
There is 1/2" reveal at the top of the filler to accommodate crown molding

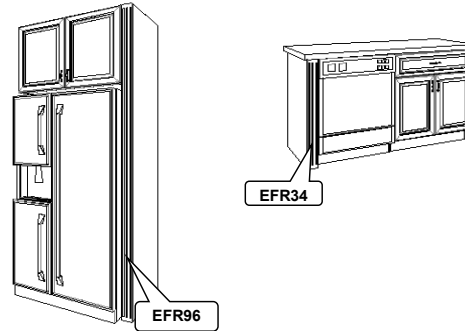
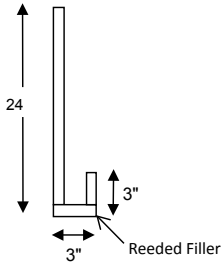

EFO End Filler Overlay (Vassar Series Only)

EFO34	24 3/4	34 1/2	3
EFO96	24 3/4	96	3
Standard Plywood EFO102	24 3/4	102	3
EFO3096	30 3/4	96	3

The Overlay Filler has a backer piece which is attached to the End Panel
There is 1/2" reveal at the top of the filler to accommodate crown molding

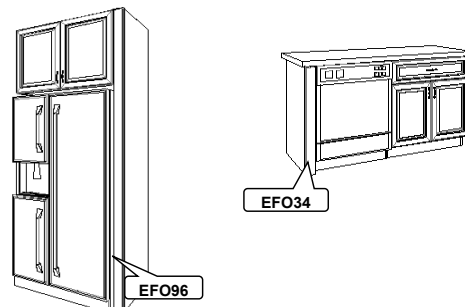
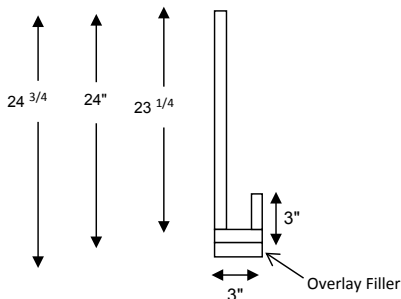

Fillers & Panels : End Fillers

End Fillers

	Depth	Height	Width
--	-------	--------	-------

EFFN End Filler Flat Narrow

	EFFN34	24	34 ^{1/2}	1.5
	EFFN96	24	96	1.5
Standard Plywood	EFFN102	24	102	1.5
	EFFN114*	24	114	1.5
	EFFN3096	30	96	1.5

The Flat filler is attached directly to the end panel

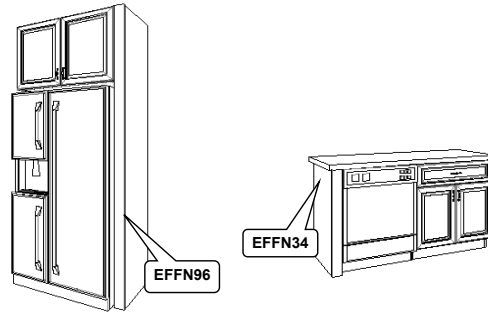
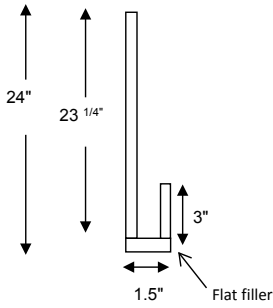

Diagonal Reeded End Filler

	DREF34	24 ^{3/4}	34 ^{1/2}	3
	DREF96	26 ^{3/8}	96	3

The Diagonal Filler is attached directly to the End Panel

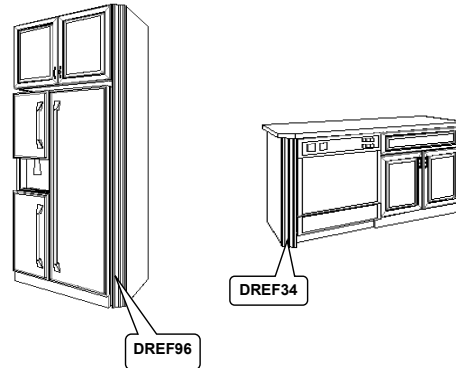
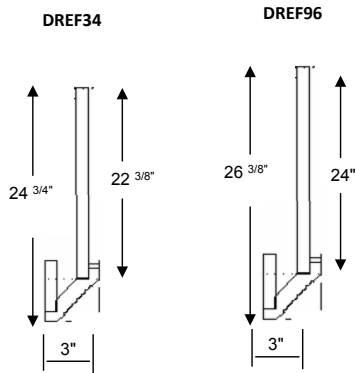

End Panel Door Program (EPDR)

- End Panel Doors (EPDR) are decorative door panels that can be ordered as separate items and applied to the finished ends of Wall, Base, and Tall cabinets.
- EPDRs are made 3/4" deeper than the cabinet side.
 - Front edge of the End Panel Door covers the face frame.
 - Meets the edge of the door on the front of the cabinet.
 - The back edge of the End Panel Door is flat so that it butts up against the wall evenly.
- The front, top and bottom edges of the End Panel Door are detailed to match the edges of the cabinet doors based upon the cabinet series you are ordering.

Note! *Since the back edge of the EPDR is flat, these should not be used to wrap around islands and peninsulas. The EPDR is designed to be used as a decorative door panel on the sides of cabinets that butt up against a wall.*

You must designate **finished ends** for all cabinets that will be receiving the decorative End Panel Doors (EPDR).

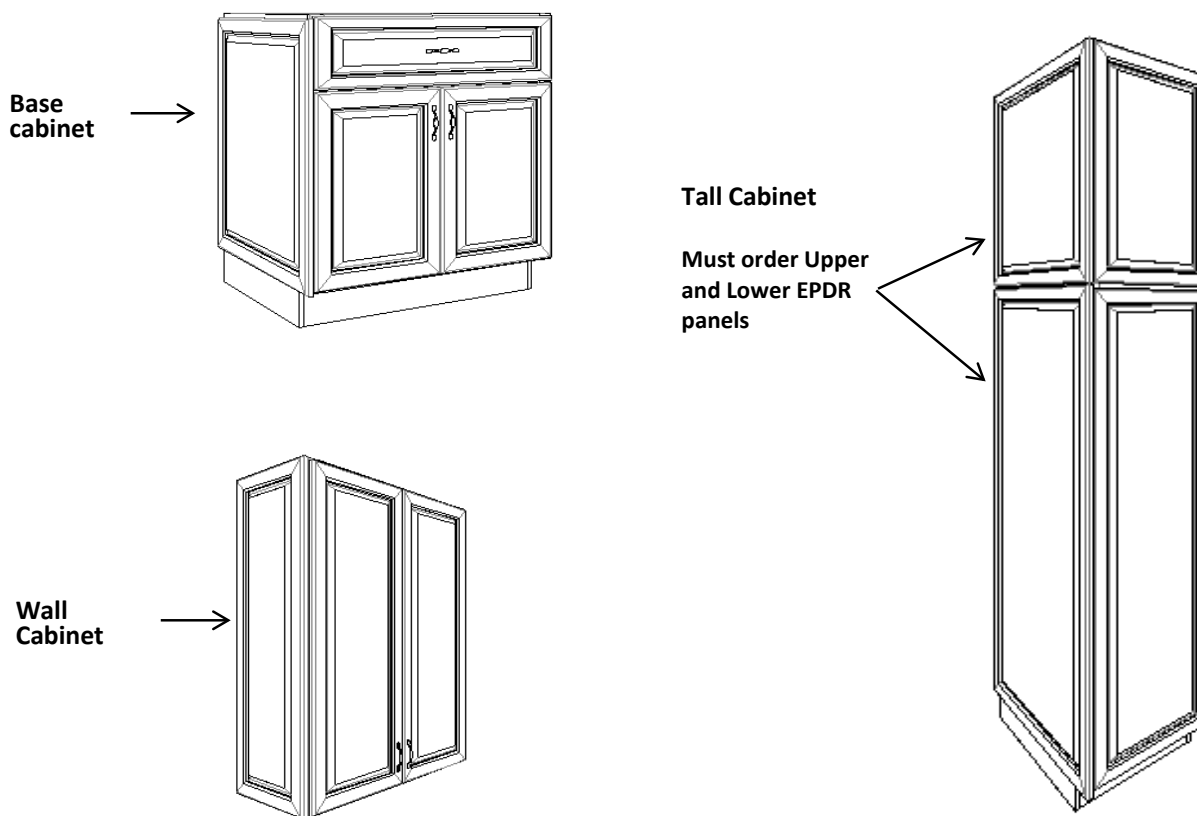

End Panel Door Program (EPDR)

GATE HOUSE SERIES		
End Panel Door Code	Width	Height
WALL EPDR1218	12 ^{13/16} x 16	^{27/32}
EPDR1224	12 ^{13/16} x 22	^{15/32}
EPDR1230	12 ^{13/16} x 29	^{13/32}
EPDR1236	12 ^{13/16} x 34	^{27/32}
EPDR1242	12 ^{13/16} x 40	^{23/32}
DESK EPDR2125	21 ^{13/16} x 24	^{3/8}
VANITY EPDR2130	21 ^{13/16} x 29	^{13/32}
BASE EPDR2430	24 ^{13/16} x 29	^{13/32}
TALLS		
UPPER EPDR2418	24 ^{13/16}	16 ^{17/32}
EPDR2424	24 ^{13/16}	22 ^{15/32}
EPDR2430	24 ^{13/16}	29 ^{13/32}
LOWER EPDR2461	24 ^{13/16}	61 ^{7/32}

CARRIAGE HOUSE SERIES		
End Panel Door Code	Width	Height
WALL EPDR1218	12 ^{13/16} x 16	^{27/32}
EPDR1224	12 ^{13/16} x 22	^{15/32}
EPDR1230	12 ^{13/16} x 29	^{13/32}
EPDR1236	12 ^{13/16} x 34	^{27/32}
EPDR1242	12 ^{13/16} x 40	^{23/32}
DESK EPDR2125	21 ^{13/16} x 24	^{3/8}
VANITY EPDR2130	21 ^{13/16} x 29	^{13/32}
BASE EPDR2430	24 ^{13/16} x 29	^{13/32}
TALLS		
UPPER EPDR2418	24 ^{13/16}	16 ^{17/32}
EPDR2424	24 ^{13/16}	22 ^{15/32}
EPDR2430	24 ^{13/16}	29 ^{13/32}
LOWER EPDR2461	24 ^{13/16}	61 ^{7/32}

VASSAR HOUSE SERIES		
End Panel Door Code	Width	Height
WALLS EPDR1218	12 ^{13/16} x 16	^{29/32}
EPDR1224	12 ^{13/16} x 22	^{5/8}
EPDR1230	12 ^{13/16} x 29	^{15/32}
EPDR1236	12 ^{13/16} x 34	^{29/32}
EPDR1242	12 ^{13/16} x 40	^{13/16}
DESK EPDR2125	21 ^{13/16} x 24	^{7/16}
VANITY EPDR2130	21 ^{13/16} x 29	^{15/32}
BASE EPDR2430	24 ^{13/16} x 29	^{15/32}
TALLS		
UPPER EPDR2418	24 ^{13/16}	16 ^{29/32}
EPDR2424	24 ^{13/16}	22 ^{5/8}
EPDR2430	24 ^{13/16}	29 ^{15/32}
LOWER EPDR2461	24 ^{13/16}	61 ^{9/32}